

NATIONAL ELIGIBILITY CUM ENTRANCE TEST

NEET (UG), 2015 (CODE-A)

Answers & Solutions

Chemistry

1. 2,3-Dimethyl-2-butene can be prepared by heating which of the following compounds with a strong acid?

- (1) $(\text{CH}_3)_2\text{C} = \text{CH} - \text{CH}_2 - \text{CH}_3$
- (2) $(\text{CH}_3)_2\text{CH} - \text{CH}_2 - \text{CH} = \text{CH}_2$
- (3)

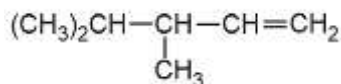

- (4) $(\text{CH}_3)_3\text{C} - \text{CH} = \text{CH}_2$

Solution: (4)

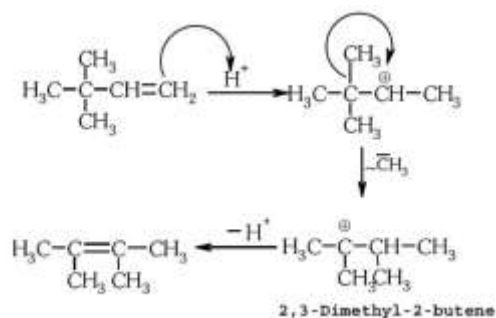

2. Gadolinium belongs of 4f series. Its atomic number is 64. Which of the following is the correct electronic configuration of gadolinium?

- (1) $[\text{Xe}]4f^7 5d^1 6s^2$
- (2) $[\text{Xe}]4f^6 5d^2 6s^2$
- (3) $[\text{Xe}]4f^8 6d^2$
- (4) $[\text{Xe}]4f^9 5s^1$

Solution: (1) ${}_{64}\text{Gd} = {}_{54}[\text{Xe}]6s^2 4f^7 5d^1$

3. The formation of the oxide ion, $\text{O}^{2-}(\text{g})$, from oxygen atom requires first an exothermic and then an endothermic step as shown in below:

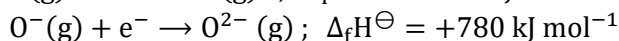
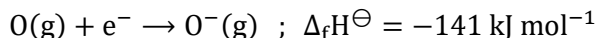

Thus process of formation of O^{2-} in gas phase is unfavourable though O^{2-} is isoelectronic with neon. It is due to the fact that,

- (1) Oxygen is more electronegative.
- (2) Addition of electron in oxygen results in larger size of the ion.
- (3) Electron repulsion outweighs the stability gained by achieving noble gas configuration.
- (4) O^- ion has comparatively smaller size than oxygen atom.

Solution: (3)

4. The number of structural isomers possible from the molecular formula $\text{C}_3\text{H}_9\text{N}$ is:

- (1) 2
- (2) 3
- (3) 4
- (4) 5

Solution: (3)

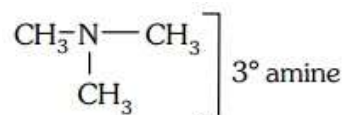
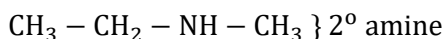
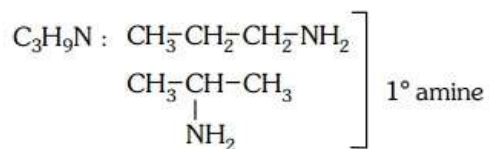

5. If the equilibrium constant for $\text{N}_2(\text{g}) + \text{O}_2(\text{g}) \rightleftharpoons 2\text{NO}(\text{g})$ is K , the equilibrium constant for $\frac{1}{2}\text{N}_2(\text{g}) + \frac{1}{2}\text{O}_2(\text{g}) \rightleftharpoons \text{NO}(\text{g})$ will be:

- (1) K
- (2) K^2
- (3) $K^{\frac{1}{2}}$
- (4) $\frac{1}{2}K$

Solution: (3) $\text{N}_2(\text{g}) + \text{O}_2(\text{g}) \rightleftharpoons 2\text{NO}(\text{g}) ; K$

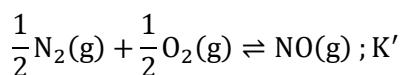

$$K = \frac{[\text{NO}]^2}{[\text{N}_2] [\text{O}_2]}$$

$$K' = \frac{[\text{NO}]}{[\text{N}_2]^{1/2}[\text{O}_2]^{1/2}}$$

$$\therefore K' = \sqrt{K}$$

6. Which one of the following pairs of solution is not an acidic buffer?

- (1) H_2CO_3 and Na_2CO_3
- (2) H_3PO_4 and Na_3PO_4
- (3) HClO_4 and NaClO_4
- (4) CH_3COOH and CH_3COONa

Solution: (3) Strong acid with its salt cannot form buffer solution. HClO_4 and NaClO_4 cannot act as an acidic buffer.

7. Aqueous solution of which of the following compounds is the best conductor of electric current?

- (1) Ammonia, NH_3
- (2) Fructose, $\text{C}_6\text{H}_{12}\text{O}_6$
- (3) Acetic acid, $\text{C}_2\text{H}_4\text{O}_2$
- (4) Hydrochloric acid, HCl

Solution: (4) Aqueous solution of HCl is the best conductor of electric current because HCl is strong acid, so it dissociates completely into ions.

8. Caprolactum is used for the manufacture of:

- (1) Terylene
- (2) Nylon-6,6
- (3) Nylon-6
- (4) Teflon

Solution: (3)

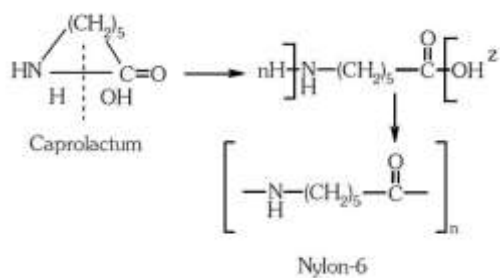

9. On heating which of the following releases CO_2 most easily?

- (1) MgCO_3
- (2) CaCO_3
- (3) K_2CO_3
- (4) Na_2CO_3

Solution: (1) Thermal stability order

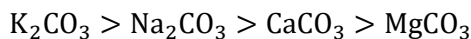

Therefore MgCO_3 releases CO_2 most easily.

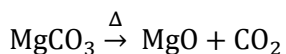

10. Strong reducing behaviour of H_3PO_2 is due to:

- (1) High oxidation state of phosphorus
- (2) Presence of two $-\text{OH}$ groups and one $\text{p}-\text{H}$ bond
- (3) Presence of one $-\text{OH}$ group and two $\text{p}-\text{H}$ bonds
- (4) High electron gain enthalpy of phosphorus

Solution: (3) Strong reducing behaviour of H_3PO_2

All oxy-acid of phosphorus which contain $\text{P}-\text{H}$ bond act as reductant.

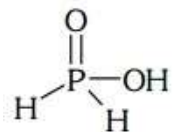

Presence of one $-\text{OH}$ group and two $\text{P}-\text{H}$ bonds.

11. Decreasing order of stability of O_2 , O_2^- , O_2^+ and O_2^{2-} is:

- (1) $\text{O}_2 > \text{O}_2^+ > \text{O}_2^{2-} > \text{O}_2^-$
- (2) $\text{O}_2^- > \text{O}_2^{2-} > \text{O}_2^+ > \text{O}_2$
- (3) $\text{O}_2^+ > \text{O}_2 > \text{O}_2^- > \text{O}_2^{2-}$

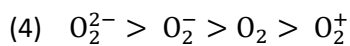

Solution: (3) Given species: $O_2, O_2^-, O_2^+, O_2^{2-}$

Total number of electrons

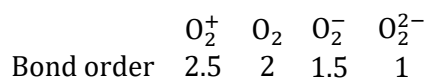
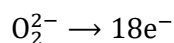
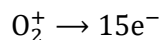
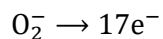
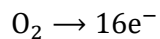

Stability \propto Bond order

Stability order [$O_2^+ > O_2 > O_2^- > O_2^{2-}$]

12. The number of water molecules is maximum in:

- (1) 18 gram of water
- (2) 18 moles of water
- (3) 18 molecules of water
- (4) 1.8 gram of water

Solution: (2) \because 1 mole water = 6.02×10^{23} molecules

\therefore 18 mole water = $18 \times 6.02 \times 10^{23}$ molecules

So, 18 mole water has maximum number of molecules.

13. In which of the following pairs, both the species are not isostructural?

- (1) NH_3, PH_3
- (2) XeF_4, XeO_4
- (3) $SiCl_4, PCl_4^+$
- (4) Diamond, silicon carbide

Solution: (2)

i. Hybridization of NH_3 [$\sigma = 3, lp = 1$]
 sp^3 geometry: Tetrahedral

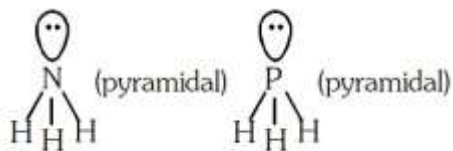

ii. Structures of XeF_4 is square planar.

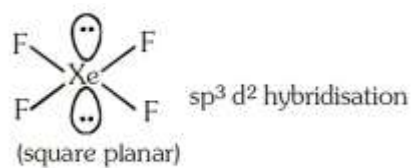

Structure of XeO_4 is tetrahedral

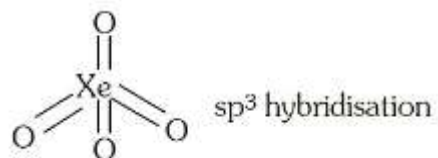

So XeF_4 and XeO_4 are not isostructural.

iii. Structure of SiCl_4 is tetrahedral.

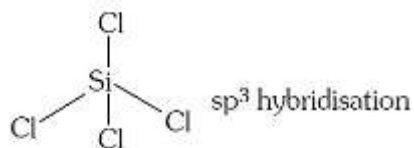

Structure of PCl_4^+ is tetrahedral.

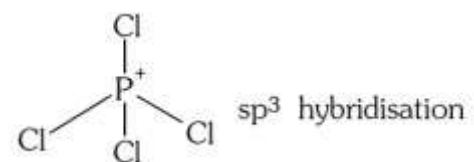

14. In the reaction with HCl, an alkene reacts in accordance with the Markovnikov's rule, to give a product 1-chloro-1-methylcyclohexane. The possible reaction alkene is:

(1)

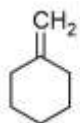

(2)

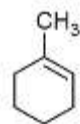

(3)

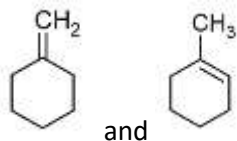

(4)

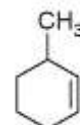

Solution: (3)

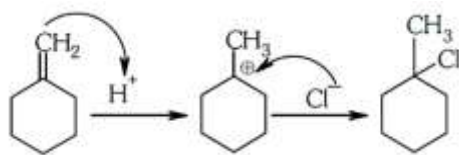

15. Assuming complete ionization, same moles of which of the following compounds will require the least amount of acidified KMnO_4 for complete oxidation?

- (1) FeC_2O_4
- (2) $\text{Fe}(\text{NO}_2)_2$
- (3) FeSO_4
- (4) FeSO_3

Solution: (3)

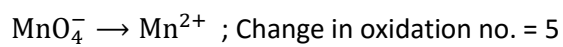

In option,

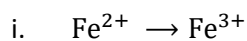

Change in oxidation no. = 1

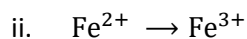

Change in oxidation no. = 1

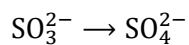

Change in oxidation no. = 2

$$= 1 + 2 = 3$$

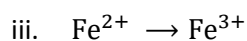

Change in oxidation no. = 1

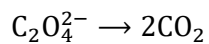

Change in oxidation no. = 2

$$= 1 + 2 = 3$$

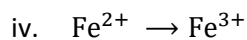

Change in oxidation no. = 1

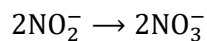

Change in oxidation no. = 4

$$= 1 + 4 = 5$$

16. Reaction of phenol with chloroform in presence of dilute sodium hydroxide finally introduces which one of the following functional group?

- (1) $-\text{CHCl}_2$
- (2) $-\text{CHO}$
- (3) $-\text{CH}_2\text{Cl}$
- (4) $-\text{COOH}$

Solution: (2) Reimer Tieman reaction

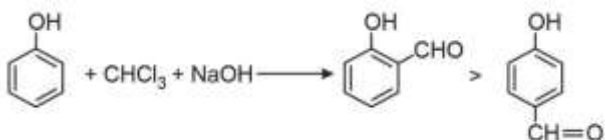

17. The vacant space in bcc lattice unit cell is:

- (1) 23%
- (2) 32%
- (3) 26%
- (4) 48%

Solution: (2) Packing efficiency in bcc lattice = 68%

$$\therefore \text{Vacant space in bcc lattice} = 100 - 68 = 32\%$$

18. Which of the statements given below is incorrect?

- (1) ONF is isoelectronic with O_2N^-
- (2) OF_2 is an oxide of fluorine
- (3) Cl_2O_7 is an anhydride of perchloric acid
- (4) O_3 molecule is bent

Solution: (2)

i. No. of electron in ONF = 24

No. of electron in $\text{NO}_2^- = 24$

Both are isoelectronic.

ii. OF_2 is a fluoride of oxygen not oxide of fluorine because EN of fluorine is more than oxygen.

$\text{OF}_2 = \text{Oxygen difluoride}$

iii. Cl_2O_7 is an anhydride of perchloric acid.

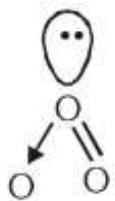
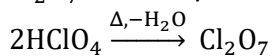

iv. O_3 molecules is bent shape.

19. The name of complex ion, $[\text{Fe}(\text{CN})_6]^{3-}$ is :

- (1) Tricyanoferrate (III) ion
- (2) Hexacyanidoferrate (III) ion
- (3) Hexacyanoiron (III) ion
- (4) Hexacyanitoferrate (III) ion

Solution: (2) $[\text{Fe}(\text{CN})_6]^{3-}$

Hexacyanidoferrate (III) ion

20. If Avogadro number N_A , is changed from $6.022 \times 10^{23} \text{ mol}^{-1}$ to $6.022 \times 10^{20} \text{ mol}^{-1}$, this would change:

- (1) The ratio of chemical species to each other in a balanced equation.
- (2) The ratio of elements to each other in a compound.
- (3) The definition of mass in units of grams
- (4) The mass of one mole of carbon

Solution: (4) \because Mass of 1 mol (6.022×10^{23} atoms) of carbon = 12g

If Avogadro Number (N_A) is changed then mass of 1 mol (6.022×10^{20} atom) of carbon

$$= \frac{12 \times 6.022 \times 10^{20}}{6.022 \times 10^{23}} = 12 \times 10^{-3} \text{ g}$$

21. Which of the following statements is not correct for a nucleophile?

- (1) Nucleophiles attack low e^- density sites
- (2) Nucleophiles are not electron seeking
- (3) Nucleophile is a Lewis acid
- (4) Ammonia is a nucleophile

Solution: (3) Reason: Nucleophiles are electron rich species so act as Lewis base.

22. A gas such as carbon monoxide would be most likely to obey the ideal gas law at:

- (1) High temperatures and high pressures
- (2) Low temperatures and low pressures
- (3) High temperatures and low pressures
- (4) Low temperatures and high pressures

Solution: (3) Real gases show ideal gas behaviour at high temperatures and low pressures.

23. The hybridization involved in complex $[\text{Ni}(\text{CN})_4]^{2-}$ is: (Atomic number of Ni = 28)

- (1) d^2sp^2
- (2) d^2sp^3
- (3) dsp^2
- (4) sp^3

Solution: (3) $[\text{Ni}(\text{CN})_4]^{2-}$

Oxidation state of Ni is +2

$$x - 4 = 2$$

$$x = +2$$

24. The heat of combustion of carbon to CO_2 is -393.5 kJ/mol . The heat released upon formation of 35.2 g of CO_2 from carbon and oxygen gas is:

- (1) -630 kJ
- (2) -3.15 kJ
- (3) -315 kJ
- (4) $+315 \text{ kJ}$

Solution: (3) Formation of CO_2 from carbon and dioxygen gas can be represented as

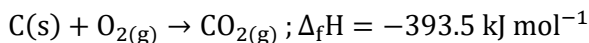

(1 mole = 44 g)

Heat released on formation of 44 g CO_2

$$= -393.5 \text{ kJ mol}^{-1}$$

$$= \frac{-393.5 \text{ kJ mol}^{-1}}{44 \text{ g}} \times 35.2 \text{ g}$$

$$= -315 \text{ kJ}$$

25. 20.0 g of a magnesium carbonate sample decomposes on heating to give carbon dioxide and 8.0 g magnesium oxide. What will be the percentage purity of magnesium carbonate in the sample?

(Atomic weight: $\text{Mg} = 24$)

- (1) 60
- (2) 84
- (3) 75
- (4) 96

Solution: (2)



$$\text{Moles of MgCO}_3 = \frac{20}{84} = 0.238 \text{ mol}$$

From above equation.

1 mole MgCO_3 gives 1 mole MgO

$\therefore 0.238 \text{ mole MgCO}_3$ will give 0.238 mole MgO

$$= 0.238 \times 40 \text{ g} = 9.523 \text{ g MgO}$$

Practical yield of $\text{MgO} = 8 \text{ g MgO}$

$$\therefore \% \text{ Purity} = \frac{8}{9.523} \times 100 = 84\%$$

26. What is the mole fraction of the solute in a 1.00 m aqueous solution?

- (1) 0.0354
- (2) 0.0177
- (3) 0.177
- (4) 1.770

Solution: (2) 1.0 m solution means 1 mole solute is present in 1000 g water.

$$n_{\text{H}_2\text{O}} = 55.5 \text{ mol H}_2\text{O}$$

$$X_{\text{Solute}} = \frac{n_{\text{Solute}}}{n_{\text{Solute}} + n_{\text{H}_2\text{O}}} = \frac{1}{1 + 55.5} = 0.0177$$

27. The correct statement regarding defects in crystalline solids is :

- (1) Frenkel defect is a dislocation defect
- (2) Frenkel defect is found in halides of alkaline metals
- (3) Schottky defects have no effect on the density of crystalline solids
- (4) Frenkel defects decrease the density of crystalline solids

Solution: (1) Frenkel defect is a dislocation defect.

28. The stability of +1 oxidation state among Al, Ga, In and Tl increases in the sequence:

- (1) Tl < In < Ga < Al
- (2) In < Tl < Ga < Al
- (3) Ga < In < Al < Tl
- (4) Al < Ga < In < Tl

Solution: (4) Stability of +1 oxidation state due to inert pair effect Tl < In < Ga < Al.

29. Two possible stereo-structures of $\text{CH}_3\text{CHOH} \cdot \text{COOH}$, which are optically active, are called:

- (1) Enantiomers
- (2) Mesomers
- (3) Diastereomers
- (4) Atropisomers

Solution: (1)

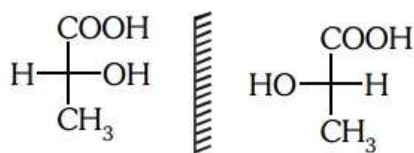

Both are enantiomers.

30. The following reaction

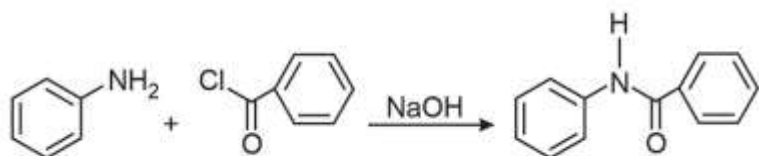

is known by the name:

- (1) Acetylation reaction
- (2) Schotten-Baumen reaction
- (3) Friedel-Craft's reaction
- (4) Perkin's reaction

Solution: (2) Benzoylation of aniline is an example of Schotten-Bauman reaction.

31. The sum of coordination number and oxidation number of metal M in the complex $[M(en)_2(C_2O_4)]Cl$ (Where en is ethylenediamine) is:

- (1) 7
- (2) 8
- (3) 9
- (4) 6

Solution: (3)

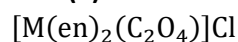

Oxidation state of M = +3

Coordination number of M = 6

Sum of oxidation state + Coordination number = 3 + 6 = 9

32. Reaction of a carbonyl compound with one of the following reagents involves nucleophilic addition followed by elimination of water. The reagent is:

- (A) Hydrocyanic acid
- (B) Sodium hydrogen sulphite
- (C) A Grignard reagent
- (D) Hydrazine in presence of feebly acidic solution

Solution: (4) With Ammonia derivation carbonyl compounds give addition followed by elimination reaction. Slightly acidic medium will generate a nucleophilic centre for weak base like ammonia derivatives.

33. Which one of the following esters gets hydrolyzed most easily under alkaline conditions?

(1)

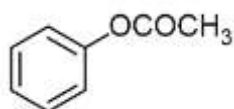

(2)

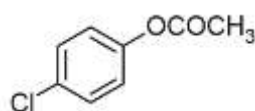

(3)

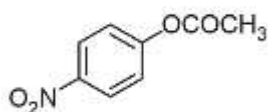

(4)

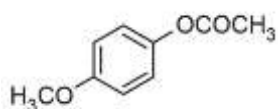

Solution: (3) EWG (Electron withdrawing group) increases reactivity towards nucleophilic substitution reaction. $-NO_2$ is strong electron withdrawing group.

34. In an S_N1 reaction on chiral centres, there is:
- (1) 100% retention
 - (2) 100% inversion
 - (3) 100% racemization
 - (4) Inversion more than retention leading to partial racemization

Solution: (4) S_N1 reaction gives racemic mixture with slight predominance of that isomer which corresponds to inversion because S_N1 also depends upon the degree of 'shielding' of the front side of the reacting carbon.

35. The rate constant of the reaction $A \rightarrow B$ is 0.6×10^{-3} mole per second. If the concentration of A is 5M, then concentration of B after 20 minutes is:
- (1) 0.36 M
 - (2) 0.72 M
 - (3) 1.08 M
 - (4) 3.60 M

Solution: (2)

For zero order reaction:

$$x = K \cdot t$$

$$= 0.6 \times 10^{-3} \times 20 \times 60$$

$$x = 0.72 \text{ M}$$

36. What is the pH of the resulting solution when equal volumes of 0.1 m NaOH and 0.01 M HCl are mixed?
- (1) 7.0
 - (2) 1.04
 - (3) 12.65
 - (4) 2.0

Solution: (3) $N_1V_1 - N_2V_2 = N \cdot V$

$$0.1 \times 1 - 0.01 \times 1 = N \times 2$$

$$[\text{OH}^-] = N_R = 0. \frac{09}{2} = 0.045 \text{ N}$$

$$\text{pOH} = -\log(0.045) = 1.35$$

$$\therefore \text{pH} = 14 - \text{pOH} = 14 - 1.35 = 12.65$$

37. Number of possible isomers for the complex $[\text{Co}(\text{en})_2\text{Cl}_2]\text{Cl}$ will be: (en = ethylene diamine)
- (1) 3
 - (2) 4
 - (3) 2
 - (4) 1

Solution: (1) $[\text{Co}(\text{en})_2\text{Cl}_2]\text{Cl}$

Possible isomers

- (i) Geometrical isomers

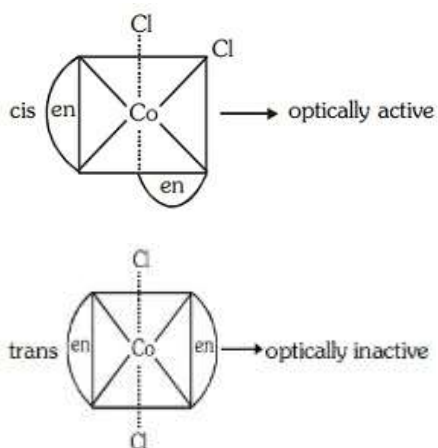

(ii) In trans form plane of symmetry present, so trans form is optically inactive but cis is optically active.

Total number of stereoisomer = 2 + 1 = 3

38. The variation of the boiling points of the hydrogen halides is in the order $\text{HF} > \text{HI} > \text{HBr} > \text{HCl}$. What explains the higher boiling point of hydrogen fluoride?

- (1) The bond energy of HF molecules is greater than in other hydrogen halides.
- (2) The effect of nuclear shielding is much reduced in fluorine which polarizes the HF molecule.
- (3) The electronegativity of fluorine is much higher than for other elements in the group.
- (4) There is strong hydrogen bonding between HF molecules.

Solution: (4) Due to strong H-bonding in HF molecule, boiling point is highest for HF.

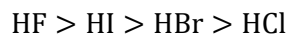

39. What is the mass of the precipitate formed when 50 mL of 16.9% solution of AgNO_3 is mixed with 50 mL of 5.8% NaCl solution?

- (1) 7 g
- (2) 14 g
- (3) 28 g
- (4) 3.5 g

Solution: (1) 16.9 g AgNO_3 is present in 100 mL solution.

\therefore 8.45 g AgNO_3 is present in 50 mL solution

5.8 g NaCl is present in 100 mL solution

\therefore 2.9 g NaCl is present in 50 mL solution

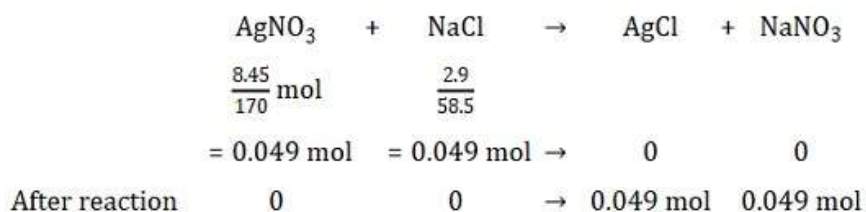

Mass of AgCl precipitated

$$= 0.049 \times 143.5 \text{ g}$$

$$= 7 \text{ g AgCl}$$

40. The oxidation of benzene by V_2O_5 in the presence of air produces:

- (1) Benzoic acid
- (2) Benzaldehyde
- (3) Benzoic anhydride
- (4) Maleic anhydride

Solution: (4)

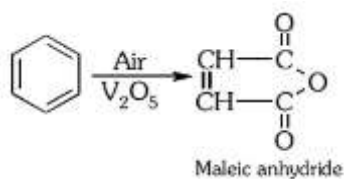

41. Which of the following is not the product of dehydration of

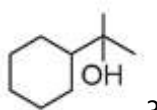

(1)

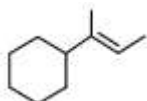

(2)

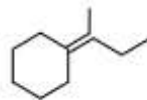

(3)

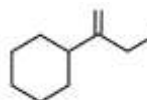

(4)

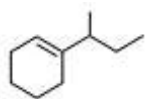

Solution: (4)

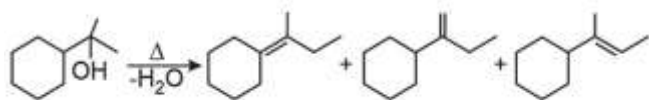

Intermediate carbocation (more stable). No rearrangement in C^+ takes place.

42. Method by which Aniline cannot be prepared is:

- (1) Reduction of nitrobenzene with H_2/Pd in ethanol.
- (2) Potassium salt of phthalimide treated with chlorobenzene followed by hydrolysis with aqueous NaOH solution.

- (3) Hydrolysis of phenylisocyanide with acidic solution
 (4) Degradation of benzamide with bromine in alkaline solution

Solution: (2)



Due to resonance C – Cl bond acquires double bond character.

43. Which of the following reaction(s) can be used for the preparation of alkyl halides?

- i. $\text{CH}_3\text{CH}_2\text{OH} + \text{HCl} \xrightarrow{\text{Anhyd. ZnCl}_2}$
 ii. $\text{CH}_3\text{CH}_2\text{OH} + \text{HCl} \rightarrow$
 iii. $(\text{CH}_3)_3\text{COH} + \text{HCl} \rightarrow$
 iv. $(\text{CH}_3)_2\text{CHOH} + \text{HCl} \xrightarrow{\text{Anhyd. ZnCl}_2}$
- (1) IV only
 (2) III and IV only
 (3) I, III and IV only
 (4) I and II only

Solution: (3) I and IV can be used due to presence of anhydrous ZnCl_2 (III) gives alkyl halide due to formation of more stable carbocation.

44. Which is the correct order of increasing energy of the listed orbitals in the atom of titanium?

(At. No. $Z = 22$)

- (1) 3s 3p 3d 4s
 (2) 3s 3p 4s 3d
 (3) 3s 4s 3p 3d
 (4) 4s 3s 3p 3d

Solution: (2) $\text{Ti}(22) = 1s^2 2s^2 2p^6 3s^2 3p^6 4s^2 3d^2$

Order of energy is 3s 3p 4s 3d

45. In the extraction of copper from its sulphide ore, the metal is finally obtained by the reduction of cuprous oxide with:

- (1) Copper (I) sulphide
 (2) Sulphur dioxide
 (3) Iron (II) sulphide
 (4) Carbon monoxide

Solution: (2) Self reduction

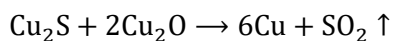

Biology

46. Root pressure is usually acidic because

- (1) Increase in transpiration
- (2) Active absorption
- (3) Low osmotic potential in soil
- (4) Passive absorption

Answer Key: (2)

Solution: As various ions from the soil are actively transported into the vascular tissues of the roots, water follows and increases the pressure inside the xylem i.e., root pressure (positive pressure).

47. Which one is a wrong statement?

- (1) Brown algae have chlorophyll a and c, and fucoxanthin
- (2) Archegonia are found in Bryophyta, Pteridophyta and Gymnosperms
- (3) *Mucor* has biflagellate zoospores
- (4) Haploid endosperm is typical feature of Gymnosperms

Answer Key: (3)

Solution: *Mucor* has non-motile spore i.e. sporangiospores.

48. Which of the following structures is not found in prokaryotic cells?

- (1) Plasma membrane
- (2) Nuclear envelope
- (3) Ribosome
- (4) Mesosome

Answer Key: (2)

Solution: True nucleus is absent in prokaryotic cell.

49. Which one of the following animals has two separate circulatory pathways?

- (1) Shark
- (2) Frog
- (3) Lizard
- (4) Whale

Answer Key: (4)

Solution: Whale is a mammal which has 4 chambered heart, so has complete separation of oxygenated and deoxygenated blood. Whale have double circulatory pathways: Systemic and pulmonary circulation.

50. Most animals that live in deep oceanic waters are :

- (1) Detritivores

- (2) Primary consumers
- (3) Secondary consumers
- (4) Tertiary consumers

Answer Key: (3)

Solution: Detritivores are an important aspect of many ecosystem. They can live on any soil with organic component, including marine ecosystem.

51. An association of individuals of different species living in the same habitat and having functional interactions is :

- (1) Population
- (2) Ecological niche
- (3) Biotic community
- (4) Ecosystem

Answer Key: (3)

Solution: Populations of different species occurring in a habitat comprise the biotic community

52. The oxygen evolved during photosynthesis comes from water molecules. Which one of the following pairs of elements is involved in this reaction?

- (1) Magnesium and Chlorine
- (2) Manganese and Chlorine
- (3) Manganese and Potassium
- (4) Magnesium and Molybdenum

Answer Key: (2)

Solution: Manganese, chlorine and calcium help in photolysis of water during light reaction of photosynthesis.

53. Axile placentation is present in :

- (1) Argemone
- (2) Dianthus
- (3) Lemon
- (4) Pea

Answer Key: (3)

Solution: The number of ovules are arranged on central axis in multilocular ovary.

54. In which of the following both pairs have correct combination?

(1)	Gaseous nutrient cycle	Sulphur and Phosphorus
	Sedimentary nutrient cycle	Carbon and Nitrogen
(2)	Gaseous nutrient cycle	Carbon and Nitrogen
	Sedimentary nutrient cycle	Sulphur and Phosphorus
(3)	Gaseous nutrient cycle	Carbon and sulphur

	Sedimentary nutrient cycle	Nitrogen and phosphorus
(4)	Gaseous nutrient cycle	Nitrogen and sulphur
	Sedimentary nutrient cycle	Carbon and Phosphorus

Answer Key: (2)

Solution: Sulphur and phosphorus are found on earth crust in the form of rocks

55. In mammalian eye, the 'fovea' is the center of the visual field, where :

- (1) More rods than cones are found.
- (2) High density of cones occur, but has no rods
- (3) The optic nerve leaves the eye
- (4) Only rods are present

Answer Key: (2)

Solution: Fovea has highest visual acuity which has only cone cells and no rod cells.

56. Choose the wrong statement:

- (1) Yeast is unicellular and useful in fermentation
- (2) *Penicillium* is multicellular and produces antibiotics
- (3) *Neurospora* is used in the study of biochemical genetics
- (4) Morels and truffles are poisonous mushrooms

Answer Key: (4)

Solution: Morels and truffles are edible fungi belong to class ascomycetes.

57. Which of the following are not membrane-bound?

- (1) Mesosomes
- (2) Vacuoles
- (3) Ribosomes
- (4) Lysosomes

Answer Key: (3)

Solution: Ribosomes are made up of r-RNA and proteins.

58. In which of the following interactions both partners are adversely affected?

- (1) Mutualism
- (2) Competition
- (3) Predation
- (4) Parasitism

Answer Key: (2)

Solution: During competition, both partners are adversely affected.

59. A colour blind man marries a woman with normal sight who has no history of colour blindness in her family. What is the probability of their grandson being colour blind?

- (1) 0.25
- (2) 0.5
- (3) 1
- (4) Nil

Answer Key: (2)

Solution:

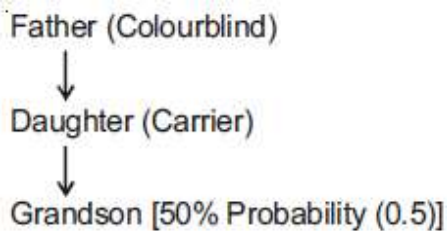

60. Ectopic pregnancies are referred to as :

- (1) Pregnancies terminated due to hormonal imbalance
- (2) Pregnancies with genetic abnormality.
- (3) Implantation of embryo at site other than uterus.
- (4) Implantation of defective embryo in the uterus

Answer Key: (3)

Solution: Any extra uterine pregnancy is ectopic pregnancy. Implantation can occur in the wall of abdominal cavity, ovaries but 90-95% of ectopic pregnancies are tubal pregnancy where implantation occurs in fallopian tube.

61. Cellular organelles with membranes are:

- (1) Lysosomes, Golgi apparatus and mitochondria
- (2) Nuclei, ribosomes and mitochondria
- (3) Chromosomes, ribosomes and endoplasmic reticulum
- (4) Endoplasmic reticulum, ribosomes and nuclei

Answer Key: (1)

Solution: Lysosomes, Golgi apparatus and mitochondria are membrane bound organelles.

62. Cell wall is absent in:

- (1) *Nostoc*
- (2) *Aspergillus*
- (3) *Funaria*
- (4) *Mycoplasma*

Answer Key: (4)

Solution: Mycoplasma is wall-less smallest living organism

63. The term "linkage" was coined by

- (1) W. Sutton
- (2) T.H. Morgan
- (3) T. Boveri
- (4) G. Mende

Answer key: (2)

Solution: The term "linkage" was coined by T.H. Morgan.

64. Which of the following biomolecules does have a phosphodiester bond?

- (1) Nucleic acids in a nucleotide
- (2) Fatty acids in a diglyceride
- (3) Monosaccharides in a polysaccharide
- (4) Amino acids in a polypeptide

Answer Key: (1)

Solution: Phosphodiester bond is formed between two nucleotides of nucleic acid.

65. The primary dentition in human differs from permanent dentition in not having one of the following type of teeth:

- (1) Incisors
- (2) Canine
- (3) Premolars
- (4) Molars

Answer Key: (3)

Solution: Dental formula of human adult (permanent dentition) = $\frac{2123}{2123}$.

Dental formula of child (primary dentition) = $\frac{2102}{2102}$

66. A protoplast is a cell:

- (1) Without division
- (2) Without plasma membrane
- (3) Without nucleus
- (4) Undergoing division

Answer Key: (1)

Solution: Plant cell — Cell wall = Protoplast

67. In which group of organisms the cells walls form two thin overlapping shells which fit together?

- (1) Slime moulds
- (2) Chrysophytes
- (3) Euglenoids
- (4) Dinoflagellates

Answer Key: (2)

Solution: Chrysophytes are photosynthetic protists. They have overlapping cell wall like soap box.

68. The DNA molecules to which the gene of interest is integrated for cloning is called:

- (1) Carrier
- (2) Transformer
- (3) Vector
- (4) Template

Answer Key: (3)

Solution: The DNA molecule to which the gene of interest is integrated for cloning is called vector.

69. Male gametophyte in angiosperms produces:

- (1) Three sperms
- (2) Two sperms and a vegetative cell
- (3) Single sperm and a vegetative cell
- (4) Single sperm and two vegetative cells

Answer Key: (2)

Solution: In angiosperms, pollen grain is first male gametophyte. Pollen grain divides into generative cell and vegetative cell. Generative cell further divides into two sperms.

70. Coconut water from a tender coconut is:

- (1) Degenerated nucellus
- (2) Immature embryo
- (3) Free nuclear endosperm
- (4) Innermost layers of the seed coat

Answer Key: (3)

Solution: Coconut water is free nuclear endosperm.

71. The species confined to a particular region and not found elsewhere is termed as:

- (1) Rare
- (2) Keystone
- (3) Alien

(4) Endemic

Answer Key: (4)

Solution: The species confined to a particular region and not found elsewhere is termed as Endemic.

72. Metagenesis refers to:

- (1) Presence of a segmented body and parthenogenetic mode of reproduction
- (2) Presence of different morphic forms
- (3) Alternation of generation between asexual and sexual phases of an organism
- (4) Occurrence of a drastic change in form during post-embryonic development

Answer Key: (3)

Solution: In coelenterates, metagenesis is alternation of generation between polyp and medusa. Polyp reproduces asexually by budding to form medusa and medusa reproduces sexually to form polyp.

73. The enzymes that is not present in succus entericus is:

- (1) Lipase
- (2) Maltase
- (3) Nucleases
- (4) Nucleosidase

Answer Key: (3)

Solution: Succus entericus is intestinal juice contains maltase, lipase, nucleosidase. Nucleases are the enzymes of pancreatic juice.

74. Eutrophication of water bodies leading to killing of fishes is mainly due to non-availability of :

- (1) Oxygen
- (2) Food
- (3) Light
- (4) Essential minerals

Answer Key: (1)

Solution: During eutrophication of water bodies, BOD level increases due to rapid growth of microbes.

75. The function of the gap junction is to :

- (1) Stop substance from leaking across a tissue
- (2) Performing cementing to keep neighbouring cells together
- (3) Facilitate communication between adjoining cells by connecting the cytoplasm for rapid transfer of ions, small molecules and some large molecules
- (4) Separate two cells from each other.

Answer Key: (3)

Solution: Gap junctions are communicating junctions in animals which facilitates communication between two adjoining cells by protein bridges for rapid transfer of ions, small molecules and large molecules.

76. Match the following list of microbes and their importance:

(a)	<i>Sacharomyces cerevisiae</i>	(i)	Production of immunosuppressive agents
(b)	<i>Monascus purpureus</i>	(ii)	Ripening of Swiss cheese
(c)	<i>Trichoderma polysporum</i>	(iii)	Commercial production of ethanol
(d)	<i>Propionibacterium shermanii</i>	(iv)	Production of blood-cholesterol lowering agents

- | | | | | |
|-----|-------|-------|------|-------|
| | (a) | (b) | (c) | (d) |
| (1) | (iii) | (i) | (iv) | (ii) |
| (2) | (iii) | (iv) | (i) | (ii) |
| (3) | (iv) | (iii) | (ii) | (i) |
| (4) | (iv) | (ii) | (i) | (iii) |

77. Arrange the following events of meiosis in correct sequence

- (a) Crossing over
- (b) Synapsis
- (c) Terminalisation of chiasmata
- (d) Disappearance of nucleolus

- (1) (b), (c), (d), (a)
- (2) (b), (a), (d), (c)
- (3) (b), (a), (c), (d)
- (4) (a), (b), (c), (d)

Answer Key: (3)

Solution: The sequence of event during meiosis are

- (1) Synapsis (Zygotene)
- (2) Crossing over (Pachytene)
- (3) Terminalisation of chiasmata
- (4) Disappearance of nucleolus

78. The cutting of DNA at specific locations became possible with the discovery of:

- (1) Ligases
- (2) Restriction enzymes
- (3) Probes
- (4) Selectable markers

Answer Key: (2)

Solution: The cutting of DNA at specific locations became possible with the discovery of restriction enzymes called molecular scissors or knife.

79. During biological nitrogen fixation, inactivation of nitrogenase by oxygen poisoning prevented by :

- (1) Cytochrome
- (2) Leghaemoglobin
- (3) Xanthophyll

- (4) Carotene

Answer Key: (2)

Solution: During Biological nitrogen fixation, inactivation of nitrogenase by oxygen poisoning is prevented by pink coloured oxygen scavenger pigment leghaemoglobin.

80. Grafted kidney may be rejected in a patient due to

- (1) Innate immune response
- (2) Humoral immune response
- (3) Cell-mediated immune response
- (4) Passive immune response

Answer Key: (3)

Solution: Cell mediated immunity (CMI) is responsible for graft rejection.

81. The body cells in cockroach discharge their nitrogenous waste in the haemolymph mainly in the Form of :

- (1) Calcium carbonate
- (2) Ammonia
- (3) Potassium urate

- (4) Urea

Answer Key: (3)

Solution: Malpighian tubules keep floating in haemolymph from where potassium waste diffuses into the Acid rain is caused by increase in the atmospheric concentration of :

82. Filiform apparatus is characteristic feature of:

- (1) Synergids
- (2) Generative cell
- (3) Nucellar embryo

- (4) Aleurone cell

Answer Key: (1)

Solution: Filiform apparatus is finger like projections in each synergid.

83. Acid rain is caused by increase in the atmospheric concentration of :

- (1) O₃ and dust
- (2) SO₂ and NO₂
- (3) SO₃ and CO

(4) CO₂ and CO

Answer Key: (2)

Solution: During rainfall, SO₂ and NO₂ can decrease the pH of rain water.

84. The wheat grain has an embryo with one large, shield-shaped cotyledon known as :

(1) Coleoptile

(2) Epiblast

(3) Coleorrhiza

(4) Scatellum

Answer Key: (4)

Solution: Scutellum is the large persistent cotyledon in embryo of wheat grain.

85. Among china rose, mustard, brinjal, potato, guava, cucumber, onion and tulip, how many plants have superior ovary?

(1) Four

(2) Five

(3) Six

(4) Three

Answer Key: (3)

Solution: Superior ovary is found in plants i.e. china rose, mustard, brinjal, potato, onion and tulip.

86. Which of the following is not a function of the skeletal system?

(1) Locomotion

(2) Production of erythrocytes

(3) Storage of minerals

(4) Production of body heat

Answer Key: (4)

Solution: Production of body heat is the function of adipose tissue.

87. Golden rice is a genetically modified crop plant where the incorporated gene is meant for biosynthesis of :

(1) Vitamin A

(2) Vitamin B

(3) Vitamin C

(4) Omega 3

Answer Key: (1)

Solution: Golden rice is nutritionally enriched rich and is meant for biosynthesis of vitamin A.

88. Chromatophores take part in :

- (1) Respiration
- (2) Photosynthesis
- (3) Growth
- (4) Movement

Answer Key: (2)

Solution: Chromatophores are photosynthetic apparatus in prokaryotes.

89. Select the wrong statement:

- (1) Mosaic disease in tobacco and AIDS in human being are caused by viruses
- (2) The viroids were discovered by D.J. Ivanowski
- (3) W.M. Stanley showed that viruses could be crystallized
- (4) The term 'contagium vivum fluidum' was coined by M.W. Beijerinck

Answer Key: (2)

Solution: The viroids were discovered by T.O. Diener.

90. A pleiotropic gene:

- (1) Controls multiple traits in an individual
- (2) Is expressed only in primitive plants
- (3) Is a gene evolved during Pliocene
- (4) Controls a trait only in combination with another gene

Answer Key: (1)

Solution: The gene which controls multiple traits in an individual.

91. Human urine is usually acidic because:

- (1) Hydrogen ions are actively secreted into the filtrate.
- (2) The sodium transporter exchanges one hydrogen ion for each sodium ion, in peritubular capillaries.
- (3) Excreted plasma proteins are acidic
- (4) Potassium and sodium exchange generates acidity

Answer Key: (1)

Solution: Tubular secretion maintains the pH and ionic balance of body fluids in which hydrogen ions are actively secreted into the filtrate and bicarbonate ions are reabsorbed.

92. Auxin can be bioassayed by :

- (1) Lettuce hypocotyl elongation
- (2) Avena coleoptile curvature
- (3) Hydroponics
- (4) Potometer

Answer Key: (2)

Solution: Avena coleoptile curvature test is the bioassay for auxin.

93. Which of the following events is not associated with ovulation in human female?

- (1) LH surge
- (2) Decrease in estradiol
- (3) Full development of Graafian follicle
- (4) Release of secondary oocyte

Answer Key: (2)

Solution: In 28 days reproductive cycle, ovulation occurs on 14th day due to LH surge. In the mid cycle, the level of FSH and estrogen are also high. The female gamete is released from the ovary in secondary oocyte stage after completing meiosis I.

94. Body having meshwork of cells, internal cavities lined with food filtering flagellated cells and indirect development are the characteristics of phylum:

- (1) Protozoa
- (2) Coelenterata
- (3) Porifera
- (4) Mollusca

Answer Key: (3)

Solution: In poriferans, the body is loose aggregate of cells (meshwork of cells). Internal cavities and canals are lined with food filtering flagellated cells i.e. choanocyte/collar cell. Choanocytes help in filter feeding.

95. Which one of the following hormones is not involved in sugar metabolism?

- (1) Glucagon
- (2) Cortisone
- (3) Aldosterone
- (4) Insulin

Answer Key: (3)

Solution: Mineralocorticoid (Aldosterone) has no role in sugar metabolism. It helps in salt metabolism.

96. Which of the following diseases is caused by a protozoan?

- (1) Blastomycosis
- (2) Syphilis
- (3) Influenza
- (4) Babesiosis

Answer Key: (4)

Solution: Babesiosis is a disease caused by a protozoan, *Babesia bigemina*. The vector is tick, so disease is also called tick fever in cattle.

97. Outbreeding is an important strategy of animal husbandry because it :

- (1) Exposes harmful recessive genes that are eliminated by selection
- (2) Helps in accumulation of superior genes.
- (3) Is useful in producing purelines of animals.
- (4) Is useful in overcoming inbreeding depression

Answer Key: (4)

Solution: A single outcross (a type of outbreeding) is useful in overcoming inbreeding depression.

98. A childless couple can be assisted to have a child through a technique called GIFT. The full form of this technique is:

- (1) Germ cell internal fallopian transfer
- (2) Gamete inseminated fallopian transfer
- (3) Gamete intra fallopian transfer

(4) Gamete internal fertilization and transfer

Answer Key: (3)

Solution: GIFT - Gamete intra fallopian transfer

99. A jawless fish, which lays eggs in fresh water and whose ammocoetes larvae after metamorphosis return to the ocean is:

(1) *Petromyzon*

(2) *Eptatretus*

(3) *Myxine*

(4) *Neomyxine*

Answer Key: (1)

Solution: Petromyzon (Lamprey) is a migratory marine water jawless fish which shows anadromous migration. It spawns in fresh water, stops feeding and dies. Its larva (Ammocoetes) after metamorphosis will return to ocean.

100. The structures that help some bacteria to attach to rocks and/or host tissues are :

(1) Holdfast

(2) Rhizoids

(3) Fimbriae

(4) Mesosomes

Answer Key: (3)

Solution: Fimbriae - Hollow tubular surface appendages, present in bacterial cell, which help in attachment to rocks and / or host tissues.

101. If you suspect major deficiency of antibodies in a person, to which of the following would you look for confirmatory evidence?

(1) Serum globulins

(2) Fibrinogen in plasma

(3) Serum albumins

(4) Haemocytes

Answer Key: (1)

Solution: Antibodies are present in serum. They are glycoproteins and also called gammaglobulins synthesized in lymph nodes.

102. In human females, meiosis-II is not completed until?

(1) Birth

(2) Puberty

(3) Fertilization

(4) Uterine implantation

Answer Key: (3)

Solution: In human females, meiosis II is completed after the entry of sperm into the cytoplasm of secondary oocyte at the time of fertilisation leading to the formation of ovum and IInd polar body.

103. Which of the following layers in an antral follicle is acellular?

(1) Zona pellucida

(2) Granulosa

(3) Theca interna

(4) Stroma

Answer Key: (1)

Solution: Zona pellucida is non-cellular membrane made up of glycoproteins. It is secreted by secondary oocyte in Graafian follicle.

104. In his classic experiments on pea plants, Mendel did not use:

- (1) Flower position
- (2) Seed colour
- (3) Pod length
- (4) Seed shape

Answer Key: (3)

Solution: Mendel did not selected Pod length as a character for study

105. Which one of the following fruits is parthenocarpic?

- (1) Banana
- (2) Brinjal
- (3) Apple
- (4) Jackfruit

Answer Key: (1)

Solution: Formation of fruit without fertilisation is called parthenocarpy. Banana is a parthenocarpic fruit therefore seedless.

106. In angiosperms, microsporogenesis and megasporogenesis :

- (1) Occur in ovule
- (2) Occur in anther
- (3) Form gametes without furthers divisions
- (4) Involve meiosis

Answer Key: (4)

Solution: In angiosperms, microsporogenesis and megasporogenesis involve meiosis

107. A gene showing codominance has:

- (1) Both alleles independently expressed in the heterozygote
- (2) One allele dominant on the other
- (3) Alleles tightly linked on the same chromosome
- (4) Alleles that are recessive to each other

Answer Key: (1)

Solution: Both alleles are independently expressed in heterozygote during codominance.

108. The chitinous exoskeleton of arthropods is formed by the polymerisation of :

- (1) Lipoglycans
- (2) Keratin sulphate and chondroitin sulphate
- (3) D-glucosamine
- (4) N-acetyl glucosamine

Answer Key: (4)

Solution: Exoskeleton of arthropods is made up of chitin. Chitin is a polymer of N-acetyl glucosamine.

109. The imperfect fungi which are decomposers of litter and help in mineral cycling belong to:

- (1) Ascomycetes
- (2) Deuteromycetes
- (3) Basidiomycetes
- (4) Phycomycetes

Answer Key: (2)

Solution: Deuteromycetes - Imperfect fungi which are decomposers of litter and help in mineral cycling.

110. The wings of a bird and the wings of an insect are :
- (1) Homologous structures and represent convergent evolution
 - (2) Homologous structures and represent divergent evolution
 - (3) Analogous structures and represent convergent evolution
 - (4) Phylogenetic structures and represent divergent evolution

Answer Key: (3)

Solution: The wings of a bird and an insect are analogous structure which differ in structure and origin but perform similar functions and represent convergent evolution.

111. Flower are unisexual in:

- (1) Onion
- (2) Pea
- (3) Cucumber
- (4) China rose

Answer Key: (3)

Solution: Flowers are unisexual in cucumber.

[Family - Cucurbitaceae]

112. Increase in concentration of the toxicant at successive trophic levels is known as :

- (1) Biogeochemical cycling
- (2) Biomagnification
- (3) Biodeterioration
- (4) Biotransformation

Answer Key: (2)

Solution: Increase in concentration of toxic substances in successive trophic level.

113. Destruction of the anterior horn cells of the spinal cord would result in loss of :-

- (1) Integrating impulses
- (2) Sensory impulses
- (3) Voluntary motor impulses
- (4) Commissural impulses

Answer Key: (3)

Solution: Anterior horn cells are ventral horn cells of spinal cord which consists of motor neurons.

114. Roots play insignificant role in absorption of water in :

- (1) Wheat
- (2) Sunflower
- (3) Pistia
- (4) Pea

Answer Key: (3)

Solution: Pistia - roots are poorly developed as it is free floating hydrophyte.

115. Match the columns and identify the correct option:

	Column I		Column II
(a)	Thylakoids	(i)	Disc-Shaped sacs in Golgi apparatus
(b)	Cristae	(ii)	Condensed structure of DNA
(c)	Cisternae	(iii)	Flat membranous sacs in stroma
(d)	Chromatin	(iv)	Infoldings in mitochondria

- | | | | | |
|-----|-------|-------|------|------|
| | (a) | (b) | (c) | (d) |
| (1) | (iii) | (iv) | (ii) | (i) |
| (2) | (iv) | (iii) | (i) | (ii) |
| (3) | (iii) | (iv) | (i) | (ii) |
| (4) | (iii) | (i) | (iv) | (ii) |

116. Identify the correct order of organisation of genetic material from largest to smallest :

- (1) Chromosome, genome, nucleotide, gene
- (2) Chromosome, gene, genome, nucleotide
- (3) Genome, chromosomes, nucleotide, gene
- (4) Genome, chromosome, gene, nucleotide

Answer Key: (4)

Solution: Order of organisation of genetic material

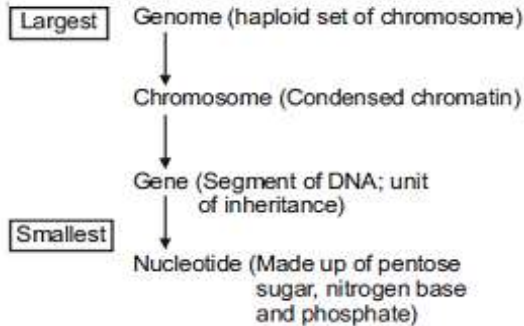

117. Which one of the following hormones though synthesis elsewhere, is stored and released by the master gland?

- (1) Melanocyte stimulating hormone
- (2) Antidiuretic hormone
- (3) Luteinizing hormone
- (4) Prolactin

Answer Key: (2)

Solution: Antidiuretic hormone is synthesized by the neurons of hypothalamus and stored in axon endings of posterior lobe of pituitary and released into the blood by posterior pituitary.

118. Read the different components from (a) to (d) in the list given below and tell the correct order of the components with reference to their arrangement from outer side to inner side in a woody dicot stem:

- (a) Secondary cortex
- (b) Wood
- (c) Secondary phloem
- (d) Phellem

The correct order is :

- (1) (d), (c), (a), (b)
- (2) (c), (d), (b), (a)
- (3) (a), (b), (d), (c)
- (4) (d), (a), (c), (b)

Answer Key: (4)

Solution: Sequence of different components of woody dicot stem from outside to inner side is:

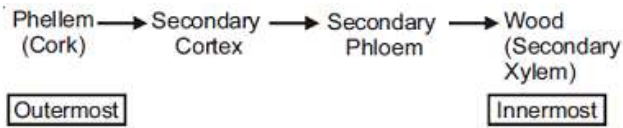

119. Which of the following joints would allow no movement?

- (1) Ball and Socket joint
- (2) Fibrous joint
- (3) Cartilaginous joint
- (4) Synovial joint

Answer Key: (2)

Solution: Fibrous joint are immovable joints where two bones are connected with the help of fibrous connective tissue.

120. Which one of the following is not applicable to RNA?

- (1) Chargaff's rule
- (2) Complementary base pairing
- (3) 5' phosphoryl and 3' hydroxyl ends
- (4) Heterocyclic nitrogenous bases

Answer Key: (1)

Solution: Chargaff's rule is applicable only for DNA.

121. Doctors use stethoscope to hear the sound; produced during each cardiac cycle. The second sound is heard when:

- (1) AV node receives signal from SA node
- (2) AV valves open up
- (3) Ventricular walls vibrate due to gushing of blood from atria
- (4) Semilunar valves close down after the blood flows into vessels from ventricles

Answer Key: (4)

Solution: Second heart sound is 'DUP' which is produced during early ventricular diastole due to the sharp closure of semilunar valves.

122. During ecological succession:

- (1) The changes lead to a community that is in near equilibrium with the environment and is called pioneer community
- (2) The gradual and predictable change in species composition occurs in a given area
- (3) The establishment of a new biotic community is very fast in its primary phase
- (4) The number and types of animals remain constant

Answer Key: (2)

Solution: Ecological succession involves gradual and fairly predictable change in the species composition of a given area.

123. In the following human pedigree, the filled symbols represent the affected individuals. Identify the type of given pedigree.

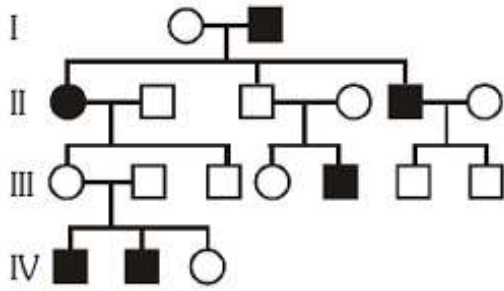

- (1) X-linked dominant
- (2) Autosomal dominant
- (3) X-linked recessive
- (4) Autosomal recessive

Answer Key: (4)

Solution: The given pedigree represents inheritance of Autosomal recessive trait.

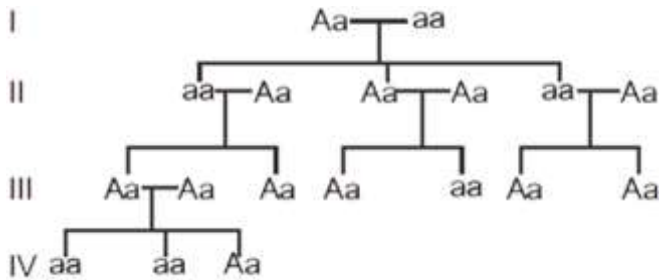

124. Balbiani rings are sites of :

- (1) RNA and protein synthesis
- (2) Lipid synthesis
- (3) Nucleotide synthesis
- (4) Polysaccharide synthesis

Answer Key: (1)

Solution: Balbiani rings are the large chromosome puff of polytene chromosomes. These are the sites of RNA and protein synthesis.

125. Name the pulmonary disease in which alveolar surface area involved in gas exchange is drastically reduced due to damage in the alveolar walls :

- (1) Asthma
- (2) Pleurisy
- (3) Emphysema
- (4) Pneumonia

Answer Key: (3)

Solution: Emphysema is mainly due to cigarette smoking in which the walls of alveoli are damaged that leads to reduction in surface area for gaseous exchange.

126. Which the following are most suitable indicator of SO₂ pollution in the environment ?

- (1) Fungi
- (2) Lichens
- (3) Conifers

(4) Algae

Answer Key: (2)

Solution: Lichens do not grow in SO_2 polluted regions therefore they indicate SO_2 pollution in air. Phycobionts of lichen are sensitive to SO_2

127. Satellite DNA is important because it :

(1) Codes for enzymes needed for DNA replication

(2) Codes for proteins needed in cell cycle

(3) Shows high degree of polymorphism in population and also the same degree of polymorphism in an individual, which is heritable from parents to children

(4) Does not code for proteins and is same in all members of the population

Answer Key: (3)

Solution: Satellite DNA are the repetitive DNA which do not code for any protein. They show high degree of polymorphism and form basis of DNA fingerprinting.

Since DNA from every tissue from an individual show the same degree of polymorphism, they become very useful identification tool in forensic applications.

128. Industrial melanism is an example of:

(1) Neo Lamarckism

(2) Neo Darwinism

(3) Natural selection

(4) Mutation

Answer Key: (3)

Solution: Industrial melanism is an example of natural selection.

129. A column of water within xylem vessels of tall trees does not break under its weight because of :

(1) Positive root pressure

(2) Dissolved sugars in water

(3) Tensile strength of water

(4) Lignification of xylem vessels

Answer Key: (3)

Solution: The column of water within Xylem vessel of tall trees does not break under its weight due to high tensile strength of water. Tensile strength is the ability to resist pulling forces.

130. The introduction of t-DNA into plants involves:

(1) Allowing the plant roots to stand in water

(2) Infection of the plant by *Agrobacterium tumefaciens*

(3) Altering the pH of the soil, then heat shocking the plants

(4) Exposing the plants to cold for a brief period

Answer Key: (2)

Solution: When *Agrobacterium tumefaciens* infects the host plant, it will transfer a part of DNA called t-DNA without any human interference so called natural genetic engineer.

131. Pick up the wrong statement :

(1) Nuclear membrane is present in Monera

(2) Cell wall is absent in Animalia

(3) Protista have photosynthetic and heterotrophic modes of nutrition

(4) Some fungi are edible

Answer Key: (1)

Solution: The members of kingdom-Monera are prokaryotes they lack nuclear membrane.

132. In photosynthesis, the light-independent reactions take place at :

- (1) Stromal matrix
- (2) Thylakoid lumen
- (3) Photosystem - I
- (4) Photosystem-II

Answer Key: (1)

Solution: Light-independent reactions or Dark reactions occur in stroma/ stromal matrix. During these reactions carbon dioxide is reduced to carbohydrates.

133. Which of the following immunoglobulins does constitute the largest percentage in human milk?

- (1) IgG
- (2) IgD
- (3) IgM
- (4) IgA

Answer Key: (4)

Solution: IgA is present in external body secretion including colostrum and milk. They provide naturally acquired passive immunity to child.

134. Which of the following pairs is not correctly matched?

	Mode of eproduction	Example
(1)	Rhizome	Banana
(2)	Binary fission	Sargassum
(3)	Conidia	Penicillium
(4)	Offset	Water hyacinth

Answer Key: (4)

Solution:

Mode of Reproduction	Example
(1) Rhizome	Banana
(2) Binary fission	<i>Saecharomyces</i> (Yeast)
(3) Conidia	<i>Penicillium</i> (Ascomycetes)
(4) Offset	Water hyacinth

135. The UN conference of Parties on climate change in the year 2012 was held at :

- (1) Warsaw
- (2) Durban
- (3) Doha
- (4) Lima

Answer Key: (3)

Solution: The United Nations Climate change conferences are yearly conferences and are known as Conference of the Parties (COP).

Physics

136. In the spectrum of hydrogen, the ratio of the longest wavelength in the Lyman series to the longest wavelength in the Balmer series is:

- (1) $\frac{5}{27}$
- (2) $\frac{4}{9}$
- (3) $\frac{9}{4}$
- (4) $\frac{27}{5}$

Solution: (1)

$$\frac{1}{\lambda_1} = R_e \left(\frac{1}{1^2} - \frac{1}{2^2} \right)$$

$$\frac{1}{\lambda_2} = R_e \left(\frac{1}{2^2} - \frac{1}{3^2} \right)$$

$$\frac{\lambda_1}{\lambda_2} = \frac{5}{27}$$

137. The energy of the em waves is of the order of 15 keV. To which part of the spectrum does it belong?

- (1) γ -rays
- (2) X-rays
- (3) Infra-red rays
- (4) Ultraviolet rays

Solution: (2)

Wavelength of the ray

$$\lambda = \frac{hc}{E}$$

$$= 0.826 \text{ \AA}$$

Since $\lambda < 100 \text{ \AA}$

So it is X-ray

138. An electron moves on a straight line path XY as shown. The abcd is a coil adjacent to the path of electron. What will be the direction of current, if any, induced in the coil?

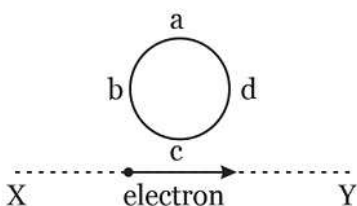

- (1) No current induced

- (2) abcd
 (3) adcb
 (4) The current will reverse its direction as the electron goes past the coil

Solution: (4)

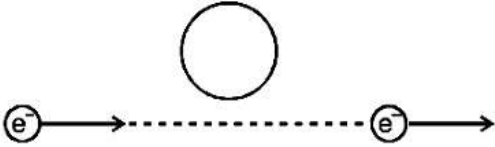

When e^- comes closer the induced current will be anticlockwise

When e^- comes farther induced current will be clockwise.

139. The cylindrical tube of a spray pump has radius R , one end of which has n fine holes, each of radius r . If the speed of the liquid in the tube is V , the speed of the ejection of the liquid through the holes is :

- (1) $\frac{V^2 R}{nr}$
 (2) $\frac{VR^2}{n^2 r^2}$
 (3) $\frac{VR^2}{nr^2}$
 (4) $\frac{VR^2}{n^3 r^2}$

Solution: (3)

Volume inflow rate = volume outflow rate

$$\pi R^2 V = n\pi r^2 v \Rightarrow v = \frac{\pi R^2 V}{n\pi r^2} = \frac{VR^2}{nr^2}$$

140. The Young's modulus of steel is twice that of brass. Two wires of same length and of same area of cross section, one of steel and another of brass are suspended from the same roof. If we want the lower ends of the wires to be at the same level, then the weights added to the steel and brass wires must be in the ratio of:

- (1) 1 : 1
 (2) 1 : 2
 (3) 2 : 1
 (4) 4 : 2

Solution: (3)

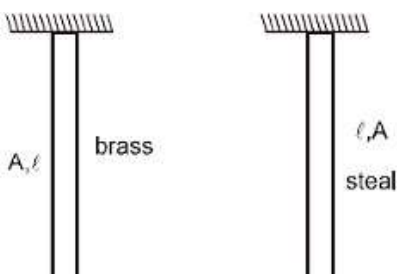

$$Y = \frac{W}{A} \cdot \frac{\ell}{\Delta\ell}$$

$$\text{So } \Delta\ell = \frac{W\ell}{AY}$$

$$\Delta e_1 = \Delta e_2 \quad \frac{w_1\ell}{AY_1} = \frac{w_2\ell}{AY_2}$$

$$\frac{w_1}{w_2} = \frac{Y_1}{Y_2} = 2$$

141. A potentiometer wire of length L and a resistance r are connected in series with a battery of e.m.f. E_0 and a resistance r_1 . An unknown e.m.f. E is balanced at a length l of the potentiometer wire. The e.m.f. E will be given by:

(1) $\frac{LE_0r}{(r+r_1)l}$

(2) $\frac{LE_0r}{l r_1}$

(3) $\frac{E_0r}{(r+r_1)} \cdot \frac{l}{L}$

(4) $\frac{E_0l}{L}$

Solution: (3)

$$K = \text{potential gradient} = \left(\frac{E_0r}{r+r_1}\right) \frac{1}{L}$$

$$\text{So } E = K\ell = \frac{E_0r\ell}{(r+r_1)L}$$

142. A particle is executing a simple harmonic motion. Its maximum acceleration is α and maximum velocity is β . Then, its time period of vibration will be:

(1) $\frac{2\pi\beta}{\alpha}$

(2) $\frac{\beta^2}{\alpha^2}$

(3) $\frac{\alpha}{\beta}$

(4) $\frac{\beta^2}{\alpha}$

Solution: (1)

$$\omega^2 A = \alpha$$

$$\omega A = \beta$$

$$\Rightarrow \omega = \frac{\alpha}{\beta}$$

$$\Rightarrow T = \frac{2\pi}{\omega} = \frac{2\pi\beta}{\alpha}$$

143. If vectors $\vec{A} = \cos \omega t \hat{i} + \sin \omega t \hat{j}$ and $\vec{B} = \cos \frac{\omega t}{2} \hat{i} + \sin \frac{\omega t}{2} \hat{j}$ are functions of times, then the value of t at which they are orthogonal to each other is:

- (1) $t = 0$
- (2) $t = \frac{\pi}{4\omega}$
- (3) $t = \frac{\pi}{2\omega}$
- (4) $t = \frac{\pi}{\omega}$

Solution: (4)

$$\bar{A} = \cos \omega t \hat{i} + \sin \omega t \hat{j}$$

$$\bar{B} = \cos \frac{\omega t}{2} \hat{i} + \sin \frac{\omega t}{2} \hat{j}$$

for $\bar{A} \cdot \bar{B} = 0$

$$\bar{A} \cdot \bar{B} = 0 = \cos \omega t \cdot \cos \frac{\omega t}{2} + \sin \omega t \cdot \sin \frac{\omega t}{2}$$

$$= \cos \left(\omega t - \frac{\omega t}{2} \right) = \cos \left(\frac{\omega t}{2} \right)$$

So $\frac{\omega t}{2} = \frac{\pi}{2} \Rightarrow t = \frac{\pi}{\omega}$

144. A source of sound S emitting waves of frequency 100 Hz and an observer O are located at some distance from each other. The source is moving with a speed of 19.4 ms^{-1} at an angle of 60° with the source observer line as shown in the figure. The observer is at rest. The apparent frequency observed by the observer (velocity of sound in air 330 ms^{-1}), is:

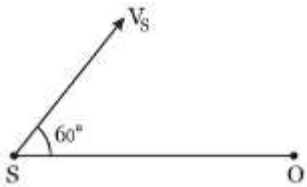

- (1) 97 Hz
- (2) 100 Hz
- (3) 103 Hz
- (4) 106 Hz

Solution: (3)

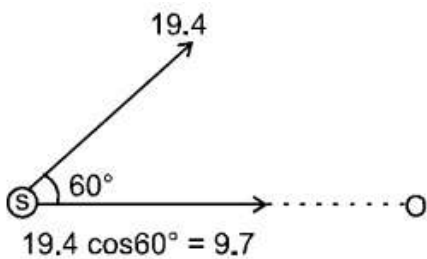

$$t^1 = f_0 \left(\frac{v - v}{v - v_s} \right)$$

$$f^1 = 100 \left(\frac{v - 0}{v - (+9.7)} \right)$$

$$f^1 = 100 \frac{v}{v \left(1 - \frac{9.7}{v}\right)}$$

$$f^1 = 100 \left(1 + \frac{3.7}{330}\right) = 103\text{Hz}$$

145. An automobile moves on a road with a speed of 54 km h^{-1} . The radius of its wheels is 0.45 m and the moment of inertia of the wheel about its axis of rotation is 3 kg m^2 . If the vehicle is brought to rest in 15s , the magnitude of average torque transmitted by its brakes to the wheel is:

- (1) $2.86 \text{ kg m}^2 \text{ s}^{-2}$
- (2) $6.66 \text{ kg m}^2 \text{ s}^{-2}$
- (3) $8.58 \text{ kg m}^2 \text{ s}^{-2}$
- (4) $10.86 \text{ kg m}^2 \text{ s}^{-2}$

Solution: (2)

$$\omega_i = \frac{15}{0.45} = \frac{100}{3} \quad \omega_f = 0$$

$$\omega_f = \omega_i + \alpha t$$

$$0 = \frac{100}{3} + (-\alpha)(15)$$

$$\alpha = \frac{100}{45}$$

$$\tau = (I)(\alpha) = 3 \times \frac{100}{45} = 6.66 \text{ N.M}$$

146. A rectangular coil of length 0.12 m and width 0.1 m having 50 turns of wire is suspended vertically in a uniform magnetic field of strength 0.2 Weber/m^2 . The coil carries a current of 2A . if the plane of the coil is inclined at an angle of 30° with the direction of the field, the torque required to keep coil in stable equilibrium will be:

- (1) 0.12 Nm
- (2) 0.15 Nm
- (3) 0.20 Nm
- (4) 0.24 Nm

Solution: (3)

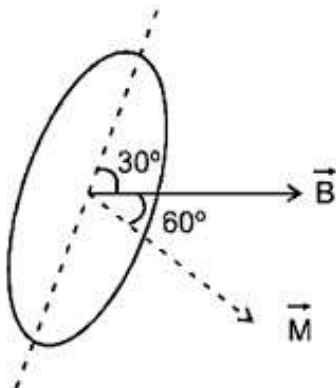

$$\begin{aligned}\vec{\tau} &= \vec{M} \times \vec{B} = MB \sin 60^\circ \\ &= Ni AB \sin 60^\circ \\ &= 50 \times 2 \times 0.12 \times 0.1 \times 0.2 \times \frac{\sqrt{3}}{2} \\ &= 12\sqrt{3} \times 10^{-2} \text{ Nm} = 0.20748 \text{ Nm}\end{aligned}$$

147. A parallel plate air capacitor has capacity 'C', distance of separation between plates is 'd' and potential difference 'V' is applied between the plates. Force of attraction between the plates of the parallel plate air capacitor is:

- (1) $\frac{C^2 V^2}{2 d^2}$
- (2) $\frac{C^2 V^2}{2 d}$
- (3) $\frac{C V^2}{2 d}$
- (4) $\frac{C V^2}{d}$

Solution: (3)

Attraction between the plates

$$F = \frac{q^2}{2A\epsilon_0} \text{ where } q = CV \text{ and } C = \frac{\epsilon_0 A}{d}$$

$$F = \frac{C^2 V^2}{2Cd} = \frac{C V^2}{2d}$$

148. Two vessels separately contain two ideal gases A and B at the same temperature, the pressure of A being twice that of B. Under such conditions, the density of A is found to be 1.5 times the density of B. The ratio of molecular weight of A and B is:

- (1) $\frac{1}{2}$
- (2) $\frac{2}{3}$
- (3) $\frac{3}{4}$
- (4) 2

Solution: (3)

$$P_A = \frac{\rho_A M_A}{RT}, P_B = \frac{\rho_B M_B}{RT} = \frac{3}{2} \Rightarrow \frac{P_A}{P_B} = \frac{\rho_A}{\rho_B} \frac{M_A}{M_B} = 2 \frac{M_A}{M_B} = \frac{3}{2}$$

$$\text{So, } \frac{M_A}{M_B} = \frac{3}{4}$$

149. A satellite S is moving in an elliptical orbit around the earth. The mass of the satellite is very small compared to the mass of the earth. Then,

- (1) The acceleration of S is always directed towards the centre of the earth
- (2) The angular momentum of S about the centre of the earth changes in direction, but its magnitude remains constant
- (3) The total mechanical energy of S varies periodically with time

(4) The linear momentum of S remains constant is magnitude

Solution: (1)

The gravitation force on the satellite will be aiming toward the centre of earth so acceleration of the satellite will also be aiming toward the centre of earth.

150. In the given figure, a diode D is connected to an external resistance $R = 100 \Omega$ and an e.m.f. of 3.5 V. If the barrier potential developed across the diode is 0.5 V, the current in the circuit will be:

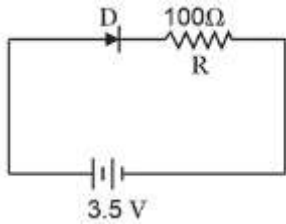

- (1) 35 mA
- (2) 30 mA
- (3) 40 mA
- (4) 20 mA

Solution: (2)

$$\begin{aligned} \text{Current} &= \frac{(3.5 - 0.5)}{100} \text{ A} \\ &= \frac{3}{100} \text{ A} = 30 \text{ mA} \end{aligned}$$

151. A remote-sensing satellite of earth revolves in a circular orbit at a height of 0.25×10^6 m above the surface of earth. If earth's radius is 6.38×10^6 m and $g = 9.8 \text{ ms}^{-2}$, then the orbital speed of the satellite is:

- (1) 6.67 km s^{-1}
- (2) 7.76 km s^{-1}
- (3) 8.56 km s^{-1}
- (4) 9.13 km s^{-1}

Solution: (2)

$$\begin{aligned} V_0 &= \sqrt{\frac{GM}{r}} = \sqrt{\frac{GM}{R^2} \cdot \frac{R^2}{r}} \\ &= \sqrt{\frac{9.8 \times 6.38 \times 6.38}{6.63 \times 10^6}} = \sqrt{60 \times 10^6} \text{ m/sec} \\ &= 7.76 \text{ km/sec} \end{aligned}$$

152. The position vector of a particle \vec{R} as a function of time is given by:

$$\vec{R} = 4 \sin(2\pi t) \hat{i} + 4 \cos(2\pi t) \hat{j}$$

Where R is in meters, t is in seconds and \hat{i} and \hat{j} denote unit vectors along x- and y-directions, respectively. Which one of the following statements is wrong for the motion of particle?

- (1) Path of the particle is a circle of radius 4 meter
- (2) Acceleration vector is along $-\vec{R}$
- (3) Magnitude of acceleration vector is $\frac{v^2}{R}$, where v is the velocity of particle
- (4) Magnitude of the velocity of particle is 8 meter/second

Solution: (4)

$$x = 4 \sin(2\pi t),$$

$$y = 4 \cos(2\pi t)$$

Squaring and adding

⇒ Circular motion

$$V = \omega R = (2\pi)(4) = 8\pi$$

So, Ans is (4)

153. A string is stretched between fixed points separated by 75.0 cm. It is observed to have resonant frequencies of 420 Hz and 315 Hz. There are no other resonant frequency for this string is:

- (1) 105 Hz
- (2) 155 Hz
- (3) 205 Hz
- (4) 105 Hz

Solution: (1)

Two consecutive resonant frequencies for a string fixed at both ends will be

$$\frac{nv}{2\ell} \text{ and } \frac{(n+1)v}{2\ell}$$

$$\Rightarrow \frac{(n+1)v}{2\ell} - \frac{nv}{2\ell} = 420 - 315$$

$$\frac{v}{2\ell} = 105 \text{ Hz}$$

Which is the minimum resonant frequency.

154. Point masses m_1 and m_2 are placed at the opposite ends of rigid rod of length L, and negligible mass. The rod is to be set rotating about an axis perpendicular to it. The position of point P on this rod through which the axis should pass so that the work required to set the rod rotating with angular velocity ω_0 is minimum, is given by:

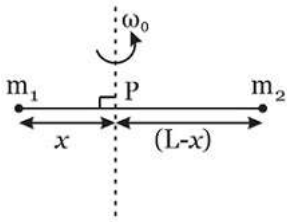

- (1) $x = \frac{m_2 L}{m_1 + m_2}$
- (2) $x = \frac{m_1 L}{m_1 + m_2}$
- (3) $x = \frac{m_1}{m_2} L$
- (4) $x = \frac{m_2}{m_1} L$

Solution: (1)

$$\text{K. E.} = \frac{1}{2} I \omega^2$$

I is min. about the centre of mass

$$\text{So, } (m_1)(x) = (m_2)(L - x)$$

$$x = \frac{m_2 L}{m_1 + m_2}$$

155. At the first minimum adjacent to the central maximum of a single-slit diffraction pattern, the phase difference between the Huygen's wavelet from the edge of the slit and the wavelet from the midpoint of the slit is:

- (1) $\frac{\pi}{8}$ radian
- (2) $\frac{\pi}{4}$ radian
- (3) $\frac{\pi}{2}$ radian
- (4) π radian

Solution: (4)

For first minima

$$AP - BP = \lambda$$

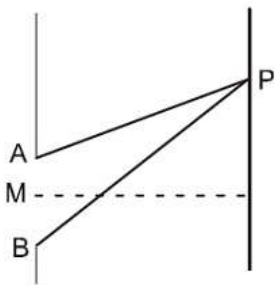

$$AP - MP = \frac{\lambda}{2}$$

So phase difference = $\frac{2\pi}{\lambda} \times \frac{\lambda}{2} = \pi$

156. A force $\vec{F} = \alpha\hat{i} + 3\hat{j} + 6\hat{k}$ is acting at a point $\vec{r} = 2\hat{i} - 6\hat{j} - 12\hat{k}$. The value of α for which angular momentum about origin is conserved is:

- (1) -
- (2) -1
- (3) 2
- (4) Zero

Solution: (2)

If $\vec{L} = \text{constant}$ then $\vec{\tau} = 0$

So $\vec{r} \times \vec{F} = 0 \Rightarrow \vec{F}$ should be parallel to \vec{r} so coefficient should be in same ratio. So $\frac{\alpha}{2} = \frac{3}{-6} = \frac{6}{-12}$

So $\alpha = -1$

Ans (4)

157. Two particles A and B move with constant velocities \vec{v}_1 and \vec{v}_2 . At the initial moment their position vectors \vec{r}_1 and \vec{r}_2 respectively. The condition for particles A and B for their collision is:

- (1) $\vec{r}_1 \times \vec{v}_1 = \vec{r}_2 \times \vec{v}_2$
- (2) $\frac{\vec{r}_1 - \vec{r}_2}{|\vec{r}_1 - \vec{r}_2|} = \frac{\vec{v}_2 - \vec{v}_1}{|\vec{v}_2 - \vec{v}_1|}$
- (3) $\vec{r}_1 \cdot \vec{v}_1 = \vec{r}_2 \cdot \vec{v}_2$
- (4) $\vec{r}_1 \times \vec{v}_1 = \vec{r}_2 \times \vec{v}_2$

Solution: (2)

For two particles to collide, the direction of the relative velocity of one with respect to other should be directed towards the relative position of the other particle

i.e. $\frac{\vec{r}_1 - \vec{r}_2}{|\vec{r}_1 - \vec{r}_2|} \rightarrow$ direction of relative position of 1 w.r.t..2.

& $\frac{\vec{v}_2 - \vec{v}_1}{|\vec{v}_2 - \vec{v}_1|} \rightarrow$ direction of velocity of 2 w.r.t.1

So for collision of A & B

$$\frac{\vec{r}_1 - \vec{r}_2}{|\vec{r}_1 - \vec{r}_2|} = \frac{\vec{v}_2 - \vec{v}_1}{|\vec{v}_2 - \vec{v}_1|}$$

158. A nucleus of uranium decays at rest into nuclei of thorium and helium. Then:

- (1) The helium nucleus has less kinetic energy than the thorium nucleus
- (2) The helium nucleus has more kinetic energy than the thorium nucleus
- (3) The helium nucleus has less momentum than the thorium nucleus
- (4) The helium nucleus has more momentum than the thorium nucleus

Solution: (2)

$$U \rightarrow \text{Th} + \alpha$$

$$KE_{\text{Th}} = \frac{p^2}{2m_{\text{Th}}}, KE_{\alpha} = \frac{p^2}{2m_{\alpha}}$$

Since m_{α} is less so KE_{α} will be more.

159. Two metal wires of identical dimensions are connected in series. If v_1 and v_2 are the conductivities of the metal wires respectively, the effective conductivity of the combination is:

- (1) $\frac{\sigma_1 \sigma_2}{\sigma_1 + \sigma_2}$
- (2) $\frac{2 \sigma_1 \sigma_2}{\sigma_1 + \sigma_2}$
- (3) $\frac{\sigma_1 + \sigma_2}{2 \sigma_1 \sigma_2}$
- (4) $\frac{\sigma_1 + \sigma_2}{\sigma_1 \sigma_2}$

Solution: (2)

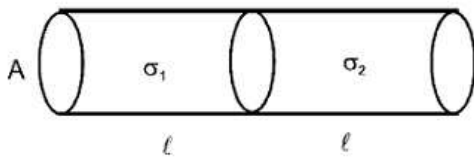

$$R_{ec} = \frac{l}{\sigma_1 A} + \frac{l}{\sigma_2 A} = \frac{l_{eq}}{\sigma_{eq} A_{eq}}$$

$$\frac{2l}{\sigma_{eq} A} = \frac{l}{A} \left(\frac{\sigma_1 + \sigma_2}{\sigma_1 \sigma_2} \right)$$

$$\sigma_{eq} = \frac{2\sigma_1 \sigma_2}{\sigma_1 + \sigma_2}$$

Ans. (2)

160. Light of wavelength 500 nm is incident on a metal with work function 2.258 eV. The de Broglie wavelength of the emitted electron is:

- (1) $\leq 2.8 \times 10^{-12}$ m
- (2) $< 2.8 \times 10^{-10}$ m
- (3) $< 2.8 \times 10^{-9}$ m
- (4) $\geq 2.8 \times 10^{-9}$ m

Solution: (4)

$$KE_{\text{max}} = \frac{hc}{\lambda} - \Psi$$

$$KE_{\max} = \frac{1240}{500} - 2.82$$

$$KE_{\max} = 2.48 - 2.28 = 0.2 \text{ eV}$$

$$\lambda_{\min} = \frac{h}{\sqrt{2m(KE)_{\max}}} = \frac{\frac{20}{3} \times 10^{-34}}{\sqrt{2 \times 9 \times 10^{-31} \times 0.2 \times 1.6 \times 10^{-19}}}$$

$$\lambda_{\min} = \frac{25}{9} \times 10^{-9} = 2.80 \times 10^{-9} \text{ nm}$$

So $\lambda \geq 2.8 \times 10^{-9} \text{ m}$

Ans. (4)

161. 4.0 g of a gas occupies 22.4 liters at NTP. The specific heat capacity of the gas at constant volume is $5.0 \text{ JK}^{-1} \text{ mol}^{-1}$. If the speed of sound in this gas at NTP is 952 ms^{-1} , then the heat capacity at constant pressure is

(Take gas constant $R = 8.3 \text{ JK}^{-1} \text{ mol}^{-1}$)

- (1) $8.5 \text{ JK}^{-1} \text{ mol}^{-1}$
- (2) $8.0 \text{ JK}^{-1} \text{ mol}^{-1}$
- (3) $7.5 \text{ JK}^{-1} \text{ mol}^{-1}$
- (4) $7.0 \text{ JK}^{-1} \text{ mol}^{-1}$

Solution: (2)

No. of mole of gas = 1 so molar mass = 4g/mole

$$V = \sqrt{\frac{\gamma RT}{m}} \Rightarrow 952 \times 952 = \frac{\gamma \times 3.3 \times 273}{4 \times 10^{-3}} \Rightarrow \gamma = 1.6 = \frac{16}{10} = \frac{8}{5}$$

162. A series R-C circuit is connected to an alternating voltage source. Consider two situations:

- i. When capacitor is air filled.
- ii. When capacitor is mica filled.

Current through resistor is i and voltage across capacitor is V then:

- (1) $V_a = V_b$
- (2) $V_a < V_b$
- (3) $V_a > V_b$
- (4) $i_a > i_b$

Solution: (3)

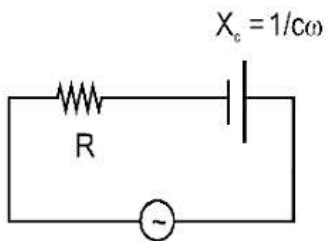

$$i = \frac{v}{\sqrt{R^2 + \left(\frac{1}{c\omega}\right)^2}}$$

$$V_C = \frac{v}{\sqrt{R^2 + \left(\frac{1}{c\omega}\right)^2}} \times \left(\frac{1}{c\omega}\right)$$

$$V_C = \frac{V}{\sqrt{(Rc\omega)^2 + 1}}$$

If we fill a di-electric material

$$C \uparrow \Rightarrow V_C \downarrow$$

Ans is (3)

163. A plank with a box on it at one end is gradually raised about the other end. As the angle of inclination with the horizontal reaches 30° , the box starts to slip and slides 4.0 m down the plank in 4.0 s. The coefficients of static and kinetic friction between the box and the plank will be, respectively:

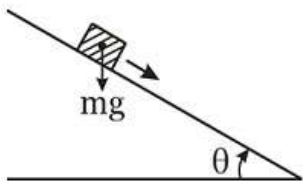

- (1) 0.4 and 0.3
- (2) 0.6 and 0.6
- (3) 0.6 and 0.5
- (4) 0.5 and 0.6

Solution: (3)

$$\mu_s = \tan 30^\circ = \frac{1}{\sqrt{3}} = 0.5$$

$$\mu_s = 0.57 = 0.6$$

$$S = ut + \frac{1}{2}at^2$$

$$4 = \frac{1}{2}a(4)^2 \Rightarrow a = \frac{1}{2} = 0.5$$

$$a = g \sin\theta - \mu_k(g)\cos\theta$$

$$\Rightarrow \mu_k = \frac{0.9}{\sqrt{3}} = 0.5$$

164. Two stones of masses ma and $2m$ are whirled in horizontal circles, the heavier one in a radius $\frac{r}{2}$ and the lighter one in radius r . the tangential speed of lighter stone is n times that of the value of heavier stone when they experience same centripetal forces. The value of n is:

- (1) 1
- (2) 2
- (3) 3
- (4) 4

Solution: (2)

$$F_C = \frac{mv_1^2}{r} = \frac{2mv_2^2}{\left(\frac{r}{2}\right)} = \frac{4mv_2^2}{r}$$

So $V_1 = 2V_2$

165. The coefficient of performance of a refrigerator is 5. If the temperature inside freezer is -20°C , the temperature of the surrounding to which is rejects heat is:

- (1) 21°C
- (2) 31°C
- (3) 41°C
- (4) 11°C

Solution: (2)

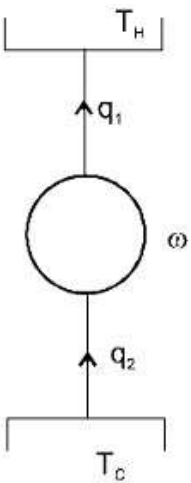

$$\text{cop} = \frac{q_1}{w} = \frac{q_2}{q_1 - q_2} = \frac{T_C}{T_H - T_C} = 5$$

$$T_C = 5T_H - 5T_C$$

$$6T_C = 5T_H$$

$$T_H = \frac{6}{5} \times 253\text{k} = 303.6\text{k} = 30.6^\circ\text{C} = 31^\circ\text{C}$$

166. An ideal gas is compressed to half its initial volume by means of several processes. Which of the process results in the maximum work done on the gas?

- (1) Isothermal
- (2) Adiabatic
- (3) Isobaric
- (4) Isochoric

Solution: (2)

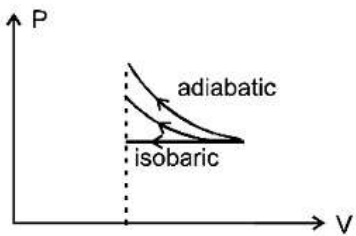

Since area under the curve is max for adiabatic process so work done on the gas will be max for adiabatic process.

167. A ball is thrown vertically downwards from a height of 20 m with an initial velocity v_0 . It collides with the ground, loses 50 percent of its energy in collision and rebounds to the same height. The initial velocity v_0 is: (Take $g = 10 \text{ ms}^{-2}$)

- (1) 10 ms^{-1}
- (2) 14 ms^{-1}
- (3) 20 ms^{-1}
- (4) 28 ms^{-1}

Solution: (3)

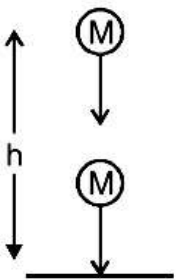

$$\frac{KE_f}{KE_i} = \frac{1}{2}$$

$$\frac{V_f}{V_i} = \frac{1}{\sqrt{2}}$$

$$\frac{\sqrt{2gh}}{\sqrt{V_0^2 + 2gh}} = \frac{1}{\sqrt{2}}$$

$$V_0 = 20 \text{ m/sec}$$

168. On a frictionless surfaces, a block of mass M moving at speed v collides elastically with another block of same mass M which is initially at rest. After collision the first block moves at an angle θ to its initial direction and has a speed $\frac{v}{3}$. The second block's speed after the collision is:

- (1) $\frac{\sqrt{3}}{2} v$
- (2) $\frac{2\sqrt{2}}{3} v$
- (3) $\frac{3}{4} v$
- (4) $\frac{3}{\sqrt{2}} v$

Solution: (2)

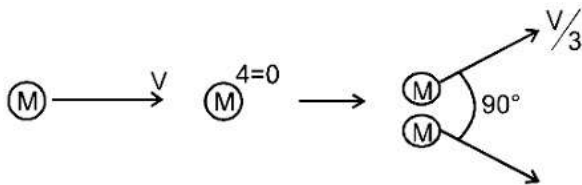

$$\vec{P}_i = \vec{P}_f$$

$$\Rightarrow |P_i| = |P_f| \Rightarrow \sqrt{\left(m \frac{V}{3}\right)^2 + (mV_2)^2}$$

$$V_2 = \frac{2\sqrt{2}}{3} V$$

169. If potential (in volts) in a region is expressed as $V(x, y, z) = 6xy - y + 2yz$, the electric field (in N/C) at point $(1, 1, 0)$ is:

- (1) $-(6\hat{i} + 9\hat{j} + \hat{k})$
- (2) $-(3\hat{i} + 5\hat{j} + 3\hat{k})$
- (3) $-(6\hat{i} + 5\hat{j} + 2\hat{k})$
- (4) $-(2\hat{i} + 3\hat{j} + \hat{k})$

Solution: (3)

$$V = 6xy - y + 24z$$

$$\vec{E} = \left(\frac{\partial V}{\partial x} \hat{i} + \frac{\partial V}{\partial y} \hat{j} + \frac{\partial V}{\partial z} \hat{k} \right)$$

$$\vec{E} = [(6y)\hat{i} + (6x - 1 + 2z)\hat{j} + (2y)\hat{k}]$$

$$\vec{E} = -(6\hat{i} + 5\hat{j} + 2\hat{k})$$

$$(1, 1, 0)$$

170. Two slits in Young's experiment have widths in the ratio 1 : 25. The ratio of intensity at the maxima and minima in the interference pattern, $\frac{I_{\max}}{I_{\min}}$ is:

- (1) $\frac{4}{9}$
- (2) $\frac{9}{4}$
- (3) $\frac{121}{49}$
- (4) $\frac{49}{121}$

Solution: (2)

$$\frac{I_1}{I_2} = \frac{25}{1} \Rightarrow \frac{A_1}{A_2} = \frac{5}{1}$$

$$\frac{A_{\max}}{A_{\min}} = \frac{5 + 1}{5 - 1} = \frac{6}{4} = \frac{3}{2}$$

$$\frac{I_{\max}}{I_{\min}} = \left(\frac{3}{2}\right)^2 = \frac{9}{4}$$

171. The heart of a man pumps 5 litres of blood through the arteries per minute at a pressure of 150 mm of mercury. If the density of mercury be $13.6 \times 10^3 \text{ kg/m}^3$ and $g = 10 \text{ m/s}^2$ then the power of heart in watt is:

- (1) 1.50
- (2) 1.70
- (3) 2.35
- (4) 3.0

Solution: (2)

$$\text{Power} = \vec{F} \cdot \vec{V} = PA\vec{V} = \rho gh AV$$

$$= 13.6 \times 10^3 \times 10 \times 150 \times 10^{-3} \times 0.5 \times 10^{-3} / 60 \text{ watt}$$

$$= \frac{102}{60} \text{ watt} = 1.70 \text{ watt.}$$

172. A proton and an alpha particle both enter a region of uniform magnetic field B, moving at right angles to the field B. If the radius of circular orbits for both the particles is equal and the kinetic energy acquired by proton is 1 MeV, the energy acquired by the alpha particle will be:

- (1) 1 MeV
- (2) 4 MeV
- (3) 0.5 MeV
- (4) 1.5 MeV

Solution: (1)

$$R = \frac{mV}{qB} = \frac{\sqrt{2m(kE)}}{qB}$$

Since R is same so $KE \propto \frac{q^2}{m}$

So KE of α particle will be $\frac{(2)^2}{4} = \text{same} = 1 \text{ MeV}$

Ans. is (1)

173. The input signal given to a CE amplifier having a voltage gain of 150 is $V_i = 2 \cos\left(15t + \frac{\pi}{3}\right)$. The corresponding output signal will be:

- (1) $300 \cos\left(15t + \frac{4\pi}{3}\right)$
- (2) $300 \cos\left(15t + \frac{\pi}{3}\right)$
- (3) $75 \cos\left(15t + \frac{2\pi}{3}\right)$
- (4) $2 \cos\left(15t + \frac{5\pi}{6}\right)$

Solution: (1)

CE amplifier causes phase difference of $\pi (= 180^\circ)$ so $V_{\text{out}} = 300 \cos\left(15t + \frac{\pi}{3} + \pi\right)$

174. If dimensions of critical velocity v_c of a liquid flowing through a tube are expressed as $[\eta^x \rho^y r^z]$, where η , ρ and r are the coefficient of viscosity of liquid, density of liquid and radius of the tube respectively, then the values of x , y and z are given by:

- (1) 1, 1, 1
- (2) 1, -1, -1
- (3) -1, -1, 1
- (4) -1, -1, -1

Solution: (2)

$$V_c = \eta^x \rho^y r^z$$

Critical velocity is given by $V_c = \frac{R\eta}{2\rho r}$

So, $x = 1$

$y = -1$

$z = -1$

175. A circuit contains an ammeter, a battery of 30 v and a resistance 40.8 ohm all connected in series. If the ammeter has coil of resistance 480 ohm and a shunt of 20 ohm, the reading in the ammeter will be:

- (1) 1 A
- (2) 0.5 A
- (3) 0.25 A
- (4) 2 A

Solution: (2)

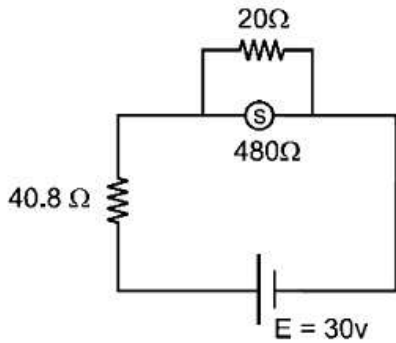

Resistance of ammeter = $\frac{480 \times 20}{480 + 20} = 19.2 \Omega$

$$i = \frac{30}{40.8 + 19.2} = 0.5 \text{ A}$$

Ans. is (2)

176. Water rises to a height 'h' in capillary tube. If the length of capillary tube above the surface of water is made less than 'h', then:

- (1) Water does not rise at all
- (2) Water rises upto the tip of capillary tube and then starts overflowing like a fountain
- (3) Water rises upto the top of capillary tube and stays there without overflowing
- (4) Water rises upto a point a little below the top and stays there

Solution: (3)

Water will not overflow but will change its radius of curvature.

177. In an astronomical telescope in normal adjustment a straight black line of the length L is drawn on inside part of objective lens. The eye-piece forms a real image of this line. The length of this image is l. The magnification of the telescope is:

- (1) $\frac{L}{l}$
- (2) $\frac{L}{l} + 1$
- (3) $\frac{L}{l} - 1$
- (4) $\frac{L+l}{L-l}$

Solution: (1)

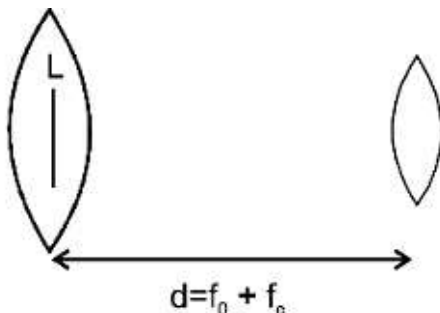

Magnification by eyepiece

$$m = \frac{f}{f+u}$$

$$-\frac{I}{L} = \frac{f_e}{f_e + (-(f_0 + f_e))}$$

$$\Rightarrow \frac{I}{L} = \frac{f_e}{f_0}$$

$$\text{m. p.} = \frac{f_0}{f_e} = \frac{L}{I}$$

178. The value of coefficient of volume expansion of glycerin is $5 \times 10^{-4} \text{K}^{-1}$. The fractional change in the density of glycerin for a rise of 40°C in its temperature is:

- (1) 0.010
- (2) 0.015
- (3) 0.020
- (4) 0.025

Solution: (3)

$$\rho = \rho_0(1 - \gamma\Delta t)$$

$$\frac{\Delta\rho}{\rho_0} = \gamma\Delta T = (5 \times 10^{-4})(40) = 0.02$$

Ans. is (3)

179. A photoelectric surface is illuminated successively by monochromatic light of wavelength λ and $\frac{\lambda}{2}$. If the maximum kinetic energy of the emitted photoelectrons in the second case is 3 times that in the first case, the work function of the surface of the material is:

(h = Planck's constant, c = speed of light)

- (1) $\frac{hc}{3\lambda}$
- (2) $\frac{hc}{2\lambda}$
- (3) $\frac{hc}{\lambda}$
- (4) $\frac{2hc}{\lambda}$

Solution: (2)

$$k_1 = \frac{hc}{\lambda} - \psi$$

$$k_2 = 3k_1 = \frac{2hc}{\lambda} - \psi = \frac{3hc}{\lambda} - 3\psi$$

$$\text{So } 2\psi = \frac{hc}{\lambda}$$

$$\text{So } \psi = \frac{hc}{2\lambda}$$

180. A beam of light consisting of red, green and blue colours is incident on a right angled prism. The refractive index of the material of the prism for the above red, green and blue wavelengths are 1.39, 1.44 and 1.47 respectively.

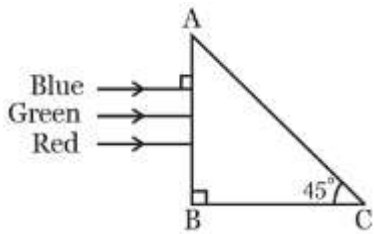

The prism will:

- (1) Separate the red colour part from the green and blue colours
- (2) Separate the blue colour part from the red and green colours
- (3) Separate all the three colours from one another
- (4) Not separate the three colours at all

Solution: (1)

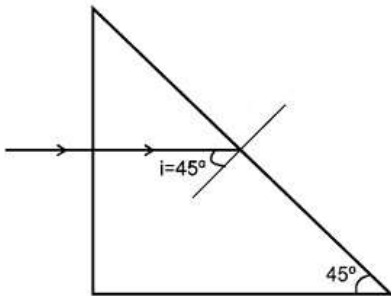

For TIR $i > I_c$ so $\sin i > \sin I_c$

$$\sin 45^\circ > \frac{1}{\mu} \Rightarrow \mu\sqrt{2} \Rightarrow \mu = 1.414$$

Since μ of green and violet are greater than 1.414 so they will total internal refracted. But red colour will be vetracted.

So Ans. is (1)