

# CBSE CLASS-XII PHYSICS QUESTIONS WITH ANSWERS

Time : 3 Hrs.

Max. Marks : 70

## General Instruction :

- All questions are compulsory. There are **26** questions in all.
- This question paper has **five** sections : Section A, Section B, Section C, Section D, Section E.
- Section A contain **five** questions of **one** mark each. Section B contains **five** questions of **two** marks each, Section C contains **twelve** questions of **three** marks each, Section D contains **one** value based question of **four** marks and Section E contains **three** questions of **five** marks each.
- There is no overall choice. However, an internal choice has been provided in one question of two marks, one question of three marks and all the three questions of five marks weightage. You have to attempt only one of the choices in such questions.
- You may use the following values of physical constants wherever necessary :

$$c = 3 \times 10^8 \text{ m/s}$$

$$h = 6.63 \times 10^{-34} \text{ Js}$$

$$e = 1.6 \times 10^{-19} \text{ C}$$

$$\mu_0 = 4\pi \times 10^{-7} \text{ T mA}^{-1}$$

$$\epsilon_0 = 8.854 \times 10^{-12} \text{ C}^2\text{N}^{-1}\text{m}^{-2}$$

$$\frac{1}{4\pi\epsilon_0} = 9 \times 10^9 \text{ N m}^2 \text{ C}^{-2}$$

$$m_e = 9.1 \times 10^{-31} \text{ kg}$$

$$\text{Mass of Neutrons} = 1.675 \times 10^{-27} \text{ kg}$$

$$\text{Mass of proton} = 1.673 \times 10^{-27} \text{ kg}$$

$$\text{Avogadro's number} = 6.023 \times 10^{23} \text{ per gram mole}$$

$$\text{Boltzmann constant} = 1.38 \times 10^{-23} \text{ JK}^{-1}$$

## SECTION A

**Q.1** Nichrome and copper wires of same length and same radius are connected in series. Current I is passed through them. Which wire gets heated up more ? Justify your answer. [1]

**Sol.** Heat dissipate in a wire is given by

$$H = I^2 R t$$

$$H = I^2 \frac{\rho \ell}{A} \times t \quad \left( \because R = \frac{\rho \ell}{A} \right)$$

For same current 'i', length ( $\ell$ ) and Area (A), H depends on

$$H \propto \rho$$

$$\rho_{\text{nichrom}} > \rho_{\text{copper}} \text{ SO,}$$

$$H_{\text{nichrome}} > H_{\text{Copper}}$$

**Q.2** Do electromagnetic waves carry energy and momentum ? [1]

**Sol.** Yes, EMW carry energy (E) and Momentum (P) is given by

$$E = \frac{hC}{\lambda}$$

$$P = mC$$

Here C is speed of EM wave in vaccum  $\lambda$  is wavelength of EM wave.

**Q.3** How does the angle of minimum deviation of a glass prism vary, if the incident violet light is replaced by red light ? Give reason. [1]

**Sol.**  $\therefore \lambda_{\text{Red}} > \lambda_{\text{Violet}}$

and we know  $\lambda \propto \frac{1}{\mu}$

so that  $\mu_{\text{Red}} < \mu_{\text{Violet}}$   
for minimum deviation

$$\mu = \frac{\sin\left(\frac{\delta_m + A}{2}\right)}{\sin\frac{A}{2}}$$

so  $(\delta_m)_{\text{Violet}} > (\delta_m)_{\text{Red}}$

**Q.4** Name the phenomenon which shows the quantum nature of electromagnetic radiation. [1]

**Sol.** "Photoelectric effect" shows the quantum nature of electromagnetic radiation.

**Q.5** Predict the polarity of the capacitor in the situation describes below : [1]

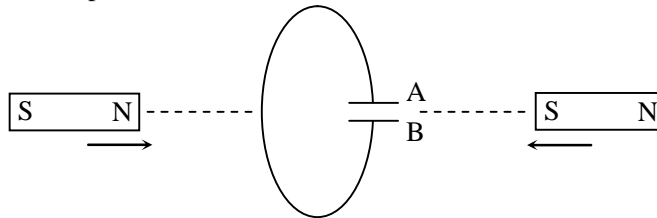

**Sol.** According to Lenz law the polarity of induced emf is such that it opposes the cause of its production so the polarity of the capacitor is as shown.

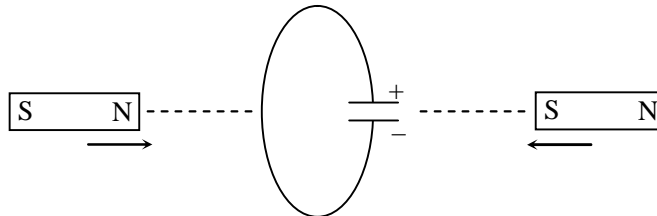

### SECTION B

**Q.6** Draw the intensity pattern for single slit diffraction and double slit interference. Hence, state two difference between interference and diffraction patterns. [2]

**OR**

Unpolarised light is passed through a polaroid  $P_1$ . When this polarised beam passes through another polaroid  $P_2$  and if the pass axis of  $P_2$  makes angle  $\theta$  with the pass axis of  $P_1$ , then write the expression for the polarised beam passing through  $P_2$ . Draw a plot showing the variation of intensity when  $\theta$  varies from 0 to  $2\pi$ .

**Sol.** Intensity distribution graph for YDSE in Young's Double Slit Experiment is shown below.

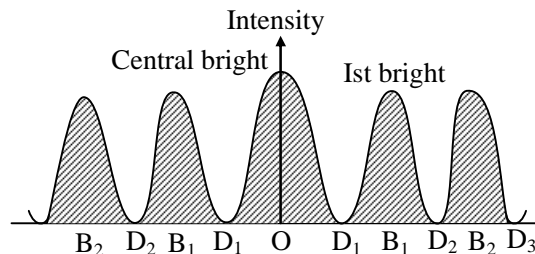

Intensity distribution graph for single slit diffraction.

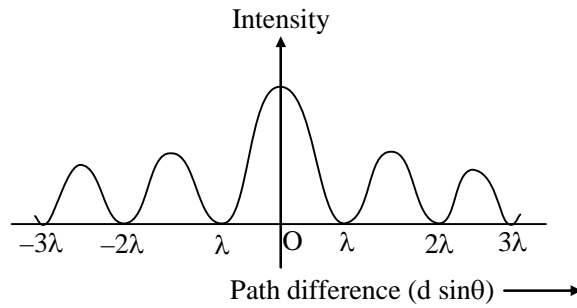

Difference between the interference pattern and the diffraction pattern.

Interference		Diffraction	
(1)	All bright and dark fringes are of equal width	(1)	The central bright fringe have got double width to that of width of secondary maxima and minima
(2)	All bright fringes are of same intensity	(2)	Central fringe is the brightest and intensity of secondary maxima decreases with increase of order of secondary maxima on either side of central maxima

OR

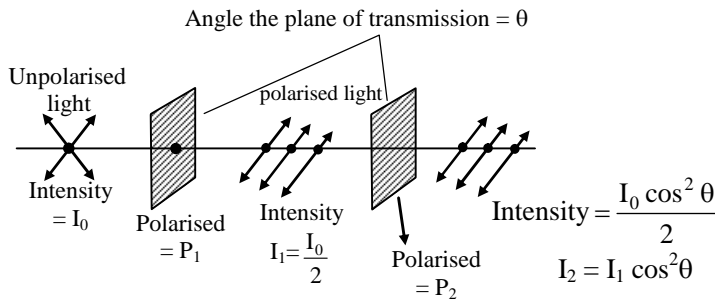

According to law of malus, when a beam of completely plane polarized light is incident on an analyzer resultant intensity of light (I) transmitted from the analyzer varies directly as the square of cosine of angle  $\theta$  between the plane of analyzer and polarizer

$$\text{i.e. } I \propto \cos^2\theta$$

$$\Rightarrow I = I_0 \cos^2\theta$$

when polarizer and analyzer and parallel

$$\theta = 0^\circ \text{ or } 180^\circ$$

$$\text{so that, } \cos\theta = \pm 1$$

$$\Rightarrow I = I_0$$

$$\text{when } \theta = 90^\circ$$

$$\Rightarrow \cos\theta = \cos 90^\circ = 0$$

$$I = 0$$

In unpolarised light, vibrations are probable in all the direction in a plane perpendicular to the direction of propagation.

Therefore,  $\theta$  can have any value from 0 and  $2\pi$ .

$$\therefore [\cos^2\theta]_{\text{av}} = \frac{1}{2\pi} \int_0^{2\pi} \cos^2\theta \, d\theta$$

$$\begin{aligned}
 &= \frac{1}{2\pi} \int_0^{2\pi} \frac{(1 + \cos 2\theta)}{2} d\theta \\
 &= \frac{1}{2\pi \times 2} \left[ \theta + \frac{\sin 2\theta}{2} \right]_0^{2\pi} \\
 &= \frac{1}{2}
 \end{aligned}$$

Using law of malus

$$I = I_0 \cos^2 \theta$$

$$I = I_0 \times \frac{1}{2} = \frac{1}{2} I_0$$

The required graph would have the form as shown in figure.

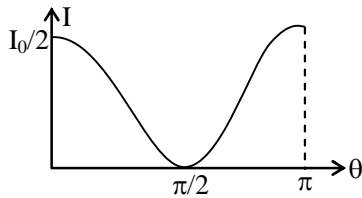

**Q.7** Identify the electromagnetic waves whose wavelengths vary as [2]

(a)  $10^{-12} \text{ m} < \lambda < 10^{-8} \text{ m}$

(b)  $10^{-3} \text{ m} < \lambda < 10^{-1} \text{ m}$

Write one use for each.

**Sol.** (a) X-ray

Used : These are used in surgery to detect fracture, damaged organs, stones in the body, etc.

(b) Gamma Rays

Used : These are used in radio therapy for the treatment of tumour and cancer.

**Q.8** Find the condition under which the charged particles moving with different speeds in the presence of electric and magnetic field vectors can be used to select charged particles of a particular speed. [2]

**Sol.** We will use electric & magnetic field

**Q.9** A 12.5 eV electron beam is used to excite a gaseous hydrogen atom at room temperature. Determine the wavelengths and the corresponding series of the lines emitted. [2]

**Sol.** The energy of gaseous hydrogen at room temperature are

$$E_1 = -13.6 \text{ eV}$$

$$E_2 = -3.4 \text{ eV}$$

$$E_3 = -1.51 \text{ eV}$$

$$E_4 = -0.85 \text{ eV}$$

$$E_3 - E_1 = -1.51 - (-13.6) = 12.09 \text{ eV and}$$

$$E_4 - E_1 = -0.85 - (-13.6) = 12.75 \text{ eV}$$

As, both the values does not match the given value but it is nearest to  $E_4 - E_1$  upto  $E_4$  energy level the hydrogen atoms would be excited

**Lyman Series :**

$$\frac{1}{\lambda} = R \left[ \frac{1}{1^2} - \frac{1}{n^2} \right]$$

for first member  $n = 2$

$$\therefore \frac{1}{\lambda_1} = R \left[ \frac{1}{1^2} - \frac{1}{2^2} \right] = 1.097 \times 10^7 \left[ \frac{4-1}{4} \right]$$

$$\Rightarrow \lambda_1 = 1.215 \times 10^{-7} \text{ m}$$

**Balmer series :**

$$\frac{1}{\lambda} = R \left[ \frac{1}{2^2} - \frac{1}{n^2} \right]$$

For first member  $n = 3$

$$\begin{aligned} \frac{1}{\lambda_1} &= R \left[ \frac{1}{2^2} - \frac{1}{3^2} \right] \\ &= 1.097 \times 10^7 \left[ \frac{1}{4} - \frac{1}{9} \right] \end{aligned}$$

$$\Rightarrow \lambda_1 = 6.56 \times 10^{-7} \text{ m}$$

**Q.10** Write two properties of a material suitable for making (a) a permanent magnet, and (b) an electromagnet. [2]

**Sol.** Two properties of material used for making permanent magnets are

(a) high coercivity

(b) high retentivity and high hysteresis loss

Two properties of material used for making electromagnets are

(a) high permeability

(b) low coercivity

**Q.11** (a) The potential difference applied across a given resistor is altered so that the heat product per second increases by a factor of 9. By what factor does the applied potential difference change? [3]

(b) In the figure shown, an ammeter A and a resistor of  $4 \Omega$  are connected to the terminals of the source. The emf of the source is 12 V having an internal resistance of  $2 \Omega$ . Calculate the voltmeter and ammeter reading.

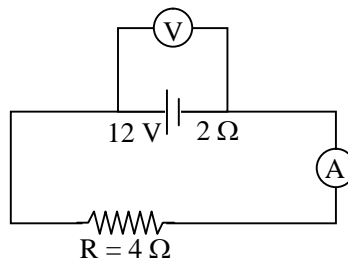

**Sol.** (a) Let the heat dissipated per unit time

$$H = \frac{V^2}{R}$$

$$H = \frac{(12)^2}{6} = 24 \text{ J/sec}$$

The new heat dissipated per unit time ( $H'$ ) =  $H \times 9 = 216 \text{ J/sec}$

Let the new voltage be  $V'$

$$\frac{(V')^2}{R} = 216$$

$$(V')^2 = 216 \times 6$$

or  $V' = 36 \text{ volt}$

(b)

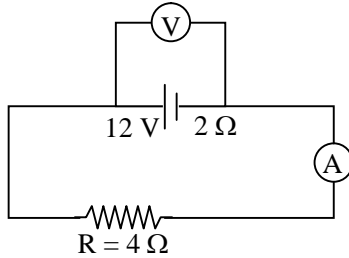

emf ( $E$ ) = 12 V

internal resistance ( $r$ ) =  $2\Omega$

external resistance ( $R$ ) =  $4\Omega$

$$\text{then current (I)} = \frac{E}{R + r} = \frac{12}{4 + 2} = \frac{12}{6} = 2\text{A}$$

so reading of ammeter will be 2A.

We know  $V = E - Ir$

$$\Rightarrow V = 12 - 2 \times 2$$

$$\Rightarrow V = 12 - 4 = 8 \text{ V}$$

So reading in voltmeter will be 8V.

**Q.12** (a) How is amplitude modulation achieved ? [3]

(b) The frequencies of two side bands in an AM wave are 640 kHz and 660 kHz respectively. Find the frequencies carrier and modulating signal. What is the bandwidth required for amplitude modulation ?

**Sol.**

In AM, the modulating wave is superimposed on a carrier wave in such a manner that the frequency of the modulated wave is the same as that of the carrier wave but its amplitude varies in accordance with the instantaneous amplitude of the modulating wave.

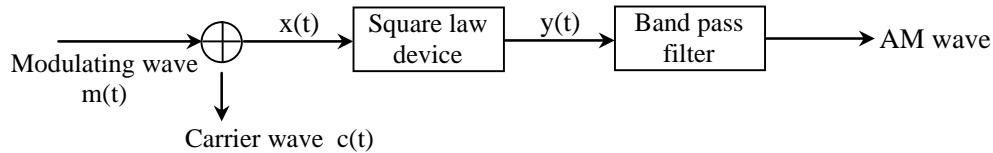

**Fig.** Block diagram for a simple modulator for obtaining an AM signal

Let the modulating signal be represent by

$$m(t) = A_m \sin\omega_m t$$

and carrier wave

$$c(t) = A_c \sin\omega_c t$$

when they added the resultant wave

$$x(t) = A_m \sin\omega_m t + A_c \sin \omega_c t$$

$$x(t) = A_c \left( 1 + \frac{A_m}{A_c} \sin \omega_m t \right) \sin \omega_c t$$

This can be further written as

$$x(t) = A_c \sin \omega_c t + \mu A_c \sin \omega_m t \times \sin \omega_c t$$

$$\mu = \frac{A_m}{A_c} \text{ is the modulation index}$$

in practice,  $\mu \leq 1$  to avoid distortion and it is represented in percent.

Using trigonometric relation

$$\sin A \sin B = \frac{1}{2} [\cos (A - B) - \cos (A + B)]$$

$$\text{So } x(t) = A_c \sin \omega_c t + \frac{\mu A_c}{2} \cos(\omega_c - \omega_m)t - \frac{\mu A_c}{2} \cos(\omega_c + \omega_m)t$$

$$(b) \text{ Given : } \omega_c + \omega_m = 660 \text{ kHz} \quad \dots(1)$$

$$\text{and } \omega_c - \omega_m = 640 \text{ kHz} \quad \dots(2)$$

eq.(1) + eq.(2)

$$2\omega_c = 660 + 640 \text{ kHz}$$

$$2\omega_c = 1300 \text{ kHz}$$

$$\omega_c = \frac{1300}{2} = 650 \text{ kHz}$$

$$\text{then } \omega_m = 650 - 640$$

$$\omega_m = 10 \text{ kHz}$$

$$\Rightarrow \omega_c = 2\pi f_c = 650 \text{ kHz} \quad (\because \omega = 2\pi f)$$

$$\Rightarrow f_c = \frac{650}{2\pi} \text{ kHz}$$

$$\Rightarrow \omega_m = 2\pi f_m = 10 \text{ kHz}$$

$$\Rightarrow f_m = \frac{10}{2\pi} \text{ kHz}$$

$$\Rightarrow \text{Band width required for amplitude modulation}$$

$$= \text{upper side band} - \text{lower side band}$$

$$= (f_c + f_m) - (f_c - f_m) = 2f_m$$

**Q.13** (a) In the following diagram, is the junction diode forward biased or reverse biased ?

[3]

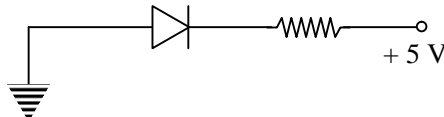

(b) Draw the circuit diagram of a full wave rectifier and state how it works.

**Sol.**

(a)

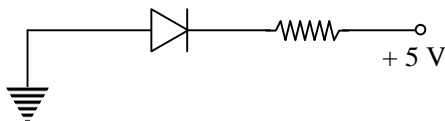

Voltage at P side is less than voltage at N side of the diode so it is in "Reverse bias".

(b) **Full wave rectifier :**

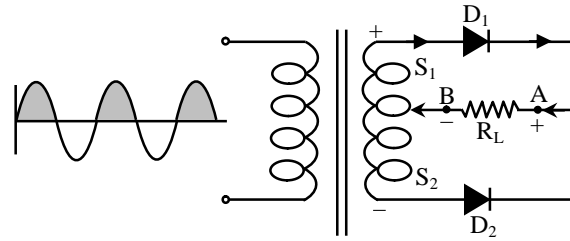

For positive half cycle

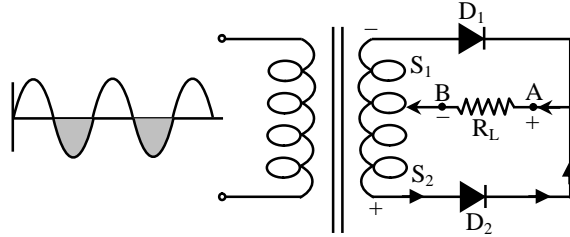

For negative half cycle

The input and output wavefront have been given below

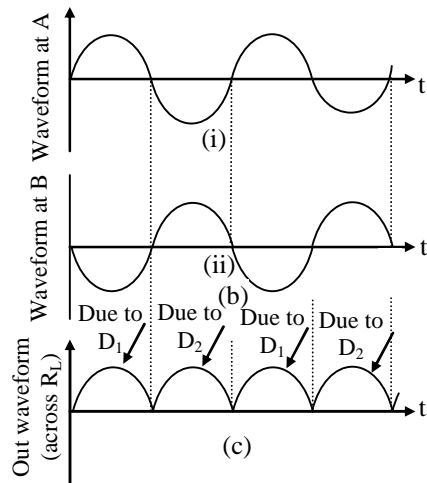

In general full wave rectifier is used to convert AC into DC.

**Working :**

- During its positive half cycle of the input AC and diode  $D_1$  is forward bias and  $D_2$  is Reverse biased. The forward current flows through diode  $D_1$ .
- During the negative half cycle of the input AC the diode  $D_1$  is reverse biased and diode  $D_2$  is forward biased. Thus current flows through diode  $D_2$ . Thus we find that during both the halves, current flows in the same direction.

**Q.14** Using photon picture of light, show how Einstein's photoelectric equation can be established. Write two features of photoelectric effect which cannot be explained by wave theory. [3]

**Sol. Einstein photoelectric equation :**

- when a photon of energy ' $h\nu$ ' falls on a metal surface the energy of the photon is absorbed by the electrons and is used in following two ways
- (i) A part of energy is used to overcome the surface barrier and come out of the metal surface. This part of energy is called "work function". It is expressed as  $\phi_0 = h\nu_0$
- (ii) The remaining part of energy is used in giving a velocity  $v$  to the emitted photoelectron. This is equal to the maximum kinetic energy of photo electrons  $\left(\frac{1}{2}mv_{\max}^2\right)$



(iii) According to the law of conservation of energy

$$h\nu = \phi_0 + \frac{1}{2}mv_{\max}^2 = h\nu_0 + \frac{1}{2}mv_{\max}^2$$

$$\therefore \frac{1}{2}mv_{\max}^2 = k_{\max} = h(\nu - \nu_0) = h\nu - \phi_0$$

$$\therefore \boxed{k_{\max} = h\nu - \phi_0}$$

This equation is called Einstein Photoelectric Equation.

- Q.15** (a) Monochromatic light of wavelength 589 nm is incident from air on a water surface. If  $\mu$  for water is 1.33, find the wavelength, frequency and speed of the refracted light. [3]  
 (b) A double convex lens is made of a glass of refractive index 1.55, with both faces of the same radius of curvature. Find the radius of curvature required, if the focal length is 20 cm.

**Sol.** (a) Given : Monochromatic light of wavelength

$$\begin{aligned} \lambda_1 &= 589 \text{ nm} \\ &= 589 \times 10^{-9} \text{ m} \end{aligned}$$

Speed light in air ( $v_1$ ) =  $3 \times 10^8$  m/s

refractive index of water =  $\mu_w = \mu_2 = 1.33$

refractive index of air  $\mu_a = \mu_1 = 1$

Find :- wavelength of refracted light ( $\lambda_2$ ) = ?

frequency of refracted light ( $f_2$ ) = ?

speed of refracted light ( $v_2$ ) = ?

**We know**

$$\frac{\lambda_1}{\lambda_2} = \frac{\mu_2}{\mu_1} = \frac{\mu_w}{\mu_a}$$

$$\frac{589 \times 10^{-9}}{\lambda_2} = \frac{1.33}{1}$$

$$\lambda_2 = \frac{589 \times 10^{-9}}{1.33} = 442.85 \times 10^{-9} = 442.85 \text{ nm}$$

$$\text{for speed } v_2 \quad \frac{\mu_w}{\mu_a} = \frac{\mu_2}{\mu_1} = \frac{v_1}{v_2}$$

$$\frac{1.33}{1} = \frac{3 \times 10^8}{v_2}$$

$$v_2 = \frac{3 \times 10^8}{1.33} = 2.25 \times 10^8 \text{ m/s}$$

for frequency  $v_2 = f\lambda_2$

$$f = \frac{v_2}{\lambda_2} = \frac{2.25 \times 10^8}{442.85 \times 10^{-9}}$$

$$f = 5.08 \times 10^{14} \text{ Hz}$$

(b) Given the refractive index of glass with respect to air  $\mu_{\text{g}}$  = 1.55

for double convex lens  $R_1 = R$ ,  $R_2 = -R$

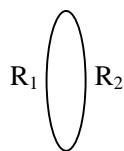

[∴ both faces have same radius of curvature]

[for double convex lens, one radius is taken as positive and other negative]

focal length of lens,  $f = + 20$  cm

Using lens formula

$$\frac{1}{f} = (\mu_g - 1) \left( \frac{1}{R_1} - \frac{1}{R_2} \right)$$

$$\Rightarrow \frac{1}{20} = (1.55 - 1) \left( \frac{1}{R} + \frac{1}{R} \right)$$

$$\Rightarrow \frac{1}{20} = 0.55 \times \frac{2}{R}$$

$$\Rightarrow R = 0.55 \times 2 \times 20 = 22 \text{ cm}$$

Thus the required radius of curvature is 22 cm.

- Q.16** Define mutual inductance between a pair of coils. Derive an expression for the mutual inductance of two long coaxial solenoids of same length wound one over the other. [3]

**OR**

Define self-inductance of a coil. Obtain the expression for the energy stored in an inductor L connected across a source of emf. [3]

- Sol.** Mutual inductance :- The phenomenon according to which an opposing emf is produced as result of change in current or magnetic flux linked with a neighboring coil.

Mutual inductance of two long wareial solenoids :

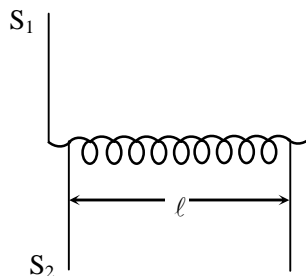

Two long wareial solenoids of same length  $\ell$  let  $n_1$  be the no. of turns per unit length of  $S_1$ ,  $n_2$  be the number of turns per unit length of  $S_2$ ,  $I_1$  be current passed through  $S_1$  and  $\phi_{21}$  be flux linked with  $S_2$  due to current flowing in  $S_1$

$$\phi_{21} \propto I_1 \text{ or } \phi_{21} = M_{21} I_1$$

where  $M_{21}$  = coefficient of mutual induction of two solenoid

when current is passed through  $S_1$ , an emf is induced in solenoid  $S_2$ . Magnetic field produced inside  $S_1$  on passing current

$$B_1 = \mu_0 n_1 I_1$$

Magnetic flux linked with each turn of the solenoid  $S_2$  will be equal to  $B_1$  times the area of cross section of solenoid  $S_1$

So, magnetic flux linked with each turn of the solenoid  $S_2 = B_1 A$

Therefore, total magnetic flux linked with solenoid  $S_2$  will be

$$\phi_{21} = B_1 A \times n_2 \ell = \mu_0 n_1 I_1 \times A \times n_2 \ell$$

$$\phi_{21} = \mu_0 n_1 n_2 A I_1 \ell$$

$$M_{21} = \mu_0 n_1 n_2 A \ell \quad \dots(i)$$

Similarly, the mutual inductance between the two solenoids, when current is passed through  $S_2$  and induced emf is produced in solenoid  $S_1$  and is given by

$$M_{12} = \mu_0 n_1 n_2 A \ell$$

$$M_{12} = M_{21} = M \text{ (say)}$$

Hence coefficient of mutual induction between the two long solenoid

$$M = \mu_0 n_1 n_2 A \ell$$

We can write equation (i) as

$$M = \mu_0 \left( \frac{N_1}{\ell} \right) \left( \frac{N_2}{\ell} \right) \pi r_1^2 \times \ell$$

$$M = \frac{\mu_0 N_1 N_2 A}{\ell}$$

if core of any other magnetic material  $\mu$  is placed the

$$M = \frac{\mu_0 \mu_r N_1 N_2 A}{\ell}$$

**OR**

Self inductance :- Self inductance is the property of a will by virtue of which, the coil opposes any change in the strength of current flowing through it by inducing an emf in itself.

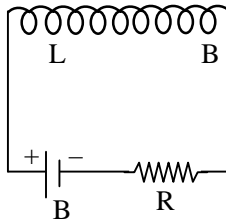

The induced emf is also called back emf

When the current in a coil is switched on. The self induction opposes the growth of the current and when the current is switched off, the self induction opposes the decay of the current

So, self-induction is also called the inertia of electricity

(ii) Self inductance of long solenoid :- A long solenoid is one whose length is very large as compared to its area of cross section.

$$\text{magnetic field (B) at any point inside } B = \frac{\mu_0 N I}{\ell} \quad \dots(i)$$

$$\text{Magnetic flux through each two of the solenoid } \phi = B \times \text{area of the each turns } \phi = \left( \mu_0 \frac{N}{\ell} I \right) A$$

Where A = area of each turn of the solenoid

Total magnetic flux linked with the solenoid = flux through each turn  $\times$  total no. of turns

$$N\phi = \mu_0 \frac{N}{\ell} I A \times N \quad \dots(ii)$$

If L is coefficient of self inductance of the solenoid then

$$\therefore N\phi = LI \quad \dots(iii)$$

from (ii) & (iii) we get

$$LI = \mu_0 \frac{N}{\ell} I A \times N$$

$$\text{or } L = \frac{\mu_0 N^2 A}{\ell} \quad \dots(\text{iv})$$

The magnitude of emf is given by

$$\text{let or } e = L \frac{dI}{dt}$$

multiplying (I) to both sides we get

$$eIdt = LI dt \quad \dots(\text{v})$$

$$\text{But } I = \frac{dq}{dt} \text{ or } Idt = dq$$

Also, work done ( $dw$ ) = voltage ( $e$ )  $\times$  charge ( $dq$ )

$$\text{or } dw = e \times dq = eIdt \quad \dots(\text{vi})$$

So from (v) & (vi)

$$dw = LI dI \quad \dots(\text{vii})$$

Total work done in increasing current from zero to  $I_0$ , we have

By integrating both sides of equation (vii) we get

$$\int_0^w dw = \int_0^{I_0} LI dI$$

$$w = \frac{1}{2} LI_0^2$$

This work done through inductor is stored as the potential energy ( $u$ ) in the magnetic field of inductor

$$u = \frac{1}{2} LI_0^2$$

- Q.17** (a) Write the principle of working of a metre bridge. [3]  
 (b) In a metre bridge, the balance point is formed at a distance  $l_1$  with resistances  $R$  and  $S$  as shown in the figure

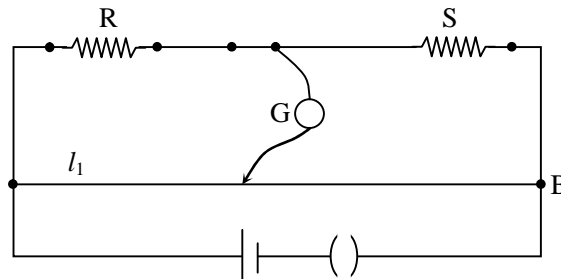

An unknown resistance  $X$  is now connected in parallel to the resistance  $S$  and the balance point is found at a distance  $l_2$ . Obtain a formula for  $X$  in terms of  $l_1$ ,  $l_2$  and  $S$ .

**Sol.** (a)

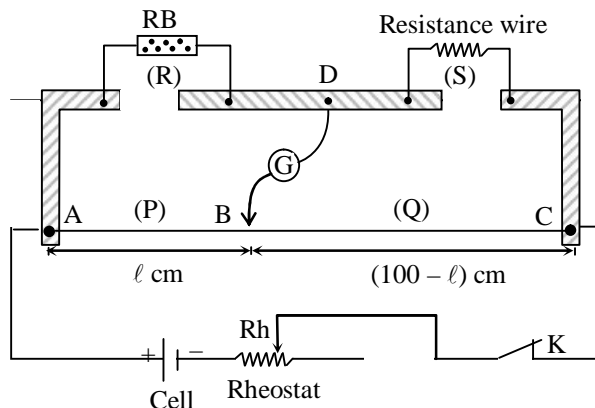

Principle :- It is constructed on the principle of balanced wheatstone bridge.

i.e., when a wheatstone bridge is balanced  $\frac{P}{Q} = \frac{R}{S}$  where the initial have usual meaning

at balancing situation of bridge

$$\frac{P}{Q} = \frac{R}{S} \Rightarrow \frac{\ell}{100 - \ell} = \frac{R}{S} \Rightarrow S = \frac{100 - \ell}{\ell} \times R$$

(b)

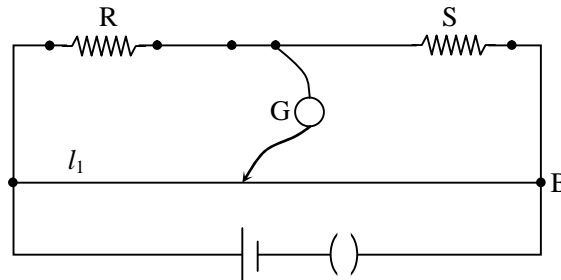

acc. to question

for first balanced bridge situation

$$\frac{R}{S} = \frac{\ell_1}{100 - \ell_1} \quad \dots(i)$$

when the  $\pi$  is connected in parallel with s the equivalent resistance is

$$S_{eq} = \frac{XS}{X + S}$$

for the second balanced bridge

$$\frac{R}{S_{eq}} = \frac{\ell_2}{100 - \ell_2}$$

$$\frac{R}{\frac{XS}{X + S}} = \frac{\ell_2}{100 - \ell_2}$$

$$\frac{R(X + S)}{XS} = \frac{\ell_2}{(100 - \ell_2)} \quad \dots(ii)$$

$$\therefore \frac{R}{S} = \frac{\ell_1}{100 - \ell_1}$$

$$\frac{(X + S)}{X} \times \frac{\ell_1}{100 - \ell_1} = \frac{\ell_2}{(100 - \ell_2)}$$

$$\frac{(X + S)}{X} = \frac{\ell_2(100 - \ell_1)}{(100 - \ell_2)\ell_1}$$

**Q.18** Draw a block diagram of a generalized communication system. Write the functions of each of the following

(a) Transmitter

(b) Channel

(c) Receiver

[3]

**Sol.** Block diagram of communication system :

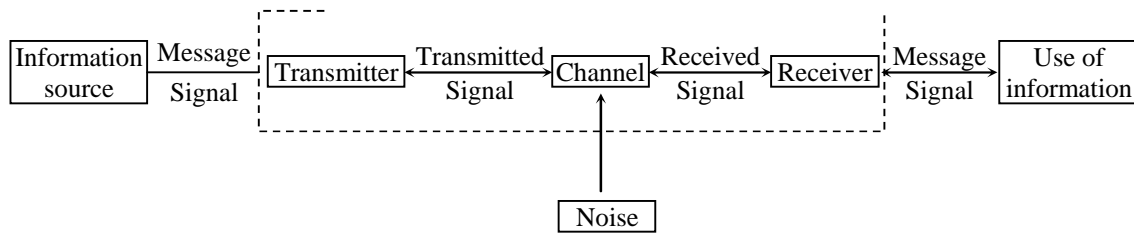

Transmitter :- A transmitter is an arrangement that converts the message signal to a form suitable for transmission and then transmits it through some suitable communication channel.

Channel :- Channel is the medium through which the signal is transmitted for transmitter to receiver.

Receiver :- A receiver extracts the desired message signals from the received signals at the channel output.

**Q.19** (a) Write the functions of the three segments of a transistor. [3]

truth table for this logic gate.

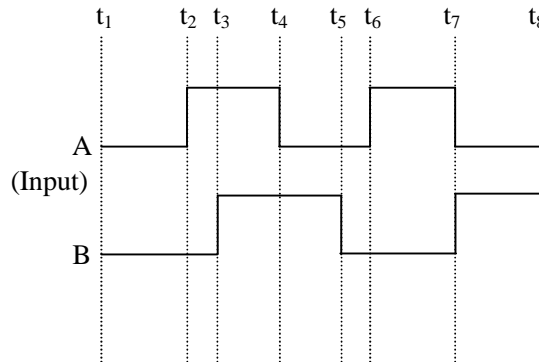

**Sol.** (a) These segments of a transistor are called emitter (E), Base (B) and collector (C)

Emitter : It is of moderate size and heavily doped. It supplies a large number of majority carrier for the current flow through the transistor

Base : Base is the control segment and it is very thin and lightly doped.

Collector : It is the segment that collects major portion of the majority carries supply by the emitter. It is moderately doped and large in size as compared to the emitter.

Input of AND gate is  $Y = A.B$  in this case output, will be 1 only when both inputs are 1

(b)

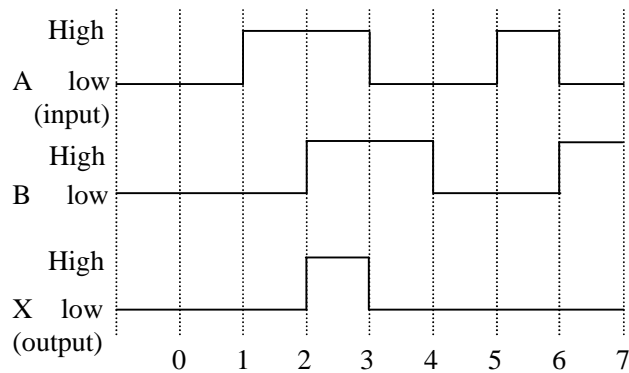

Input		Output
A	B	$Y = A.B$
0	0	0
0	1	0
1	0	0
1	1	1

- Q.20** (a) Draw a ray diagram depicting the formation of the image by an astronomical telescope in normal adjustment [3]  
 (b) You are given the following three lenses. Which two lenses will you use as an eyepiece and as an objective to construct an astronomical telescope? Give reason.

Lenses	Power (D)	Aperture (cm)
L <sub>1</sub>	3	8
L <sub>2</sub>	6	1
L <sub>3</sub>	10	1

**Sol.** (a) Ray diagram of Astronomical telescope :

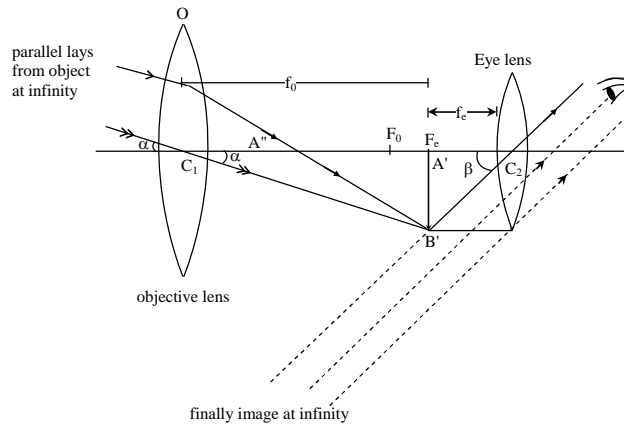

- (b) We use L<sub>1</sub> as an objective lens because it has higher aperture. That is 8 cm. So that it has high resolving power and lens L<sub>3</sub> use as an eye piece because it has high power. So that magnification is more.

- Q.21** (a) State Biot – Savart law and express this law in the vector form. [3]  
 (b) Two identical circular coils, P and Q each of radius R, carrying currents 1A and  $\sqrt{3}$  A respectively, are placed concentrically and perpendicular to each other lying in the XY and YZ planes. Find the magnitude and direction of the net magnetic field at the centre of the coils.

**Sol.** (a) Biot-savart's law :- This law states that the magnetic field (dB) at point P due to small current element Idℓ of current carrying conductor is

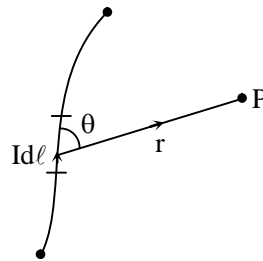

- (i) directly proportional to the Idℓ (current) element of the conductor.  $dB \propto Id\ell$   
 (ii) directly proportional to  $\sin\theta$   $dB \propto \sin\theta$ ,  $\theta$  is the angle b/w  $d\ell$  and  $r$ .

- (iii) inversely proportional to the square of the distance of point p from the current element  $dB \propto \frac{1}{r^2}$

Combining all the inequalities

$$dB \propto \frac{Id\ell \sin\theta}{r^2} = \frac{\mu_0}{4\pi} \frac{Id\ell \sin\theta}{r^2}$$

where  $\frac{\mu_0}{4\pi} = 10^{-7}$  T-m/A for free space

The direction of magnetic field can be obtained using right hand thumb rule

$$dB = \frac{\mu_0}{4\pi} \cdot \frac{Id\ell \times \hat{r}}{r^2}$$

in vector form Biot.savaut's law can be written as

$$dB \propto \frac{Id\ell \times r}{r^3} = \frac{\ell_w}{4\pi} \frac{Id\ell \times r}{r^3}$$

(b)

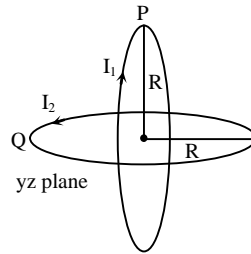

$$I_1 = 1A$$

$$I_2 = \sqrt{3} A$$

magnetic field due to coil P at its centre is

$$B_P = \frac{\mu_0 I_1}{2R} \text{ along z axis}$$

magnetic field due to coil Q at its centre is

$$B_Q = \frac{\mu_0 I_2}{2R} \text{ along x axis}$$

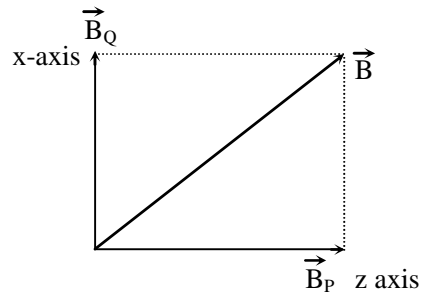

Resultant magnetic field is

$$\begin{aligned} B &= \sqrt{B_P^2 + B_Q^2} \\ &= \sqrt{\left(\frac{\mu_0 I_1}{2R}\right)^2 + \left(\frac{\mu_0 I_2}{2R}\right)^2} = \sqrt{\left(\frac{\mu_0}{2R}\right)^2 (I_1^2 + I_2^2)} \\ &= \frac{\mu_0}{2R} \sqrt{1^2 + (\sqrt{3})^2} = \frac{\mu_0}{2R} \times 2 = \frac{\mu_0}{R} \end{aligned}$$

and its direction is in X – Z plane



- Q.22** Two identical parallel plate capacitors A and B are connected to a battery of V volts with the switch S closed. The switch is now opened and the free space between the plates of the capacitors is filled with a dielectric of dielectric constant K. Find the ratio of the total electrostatic energy stored in both capacitors before and after the introduction of the dielectric. [3]

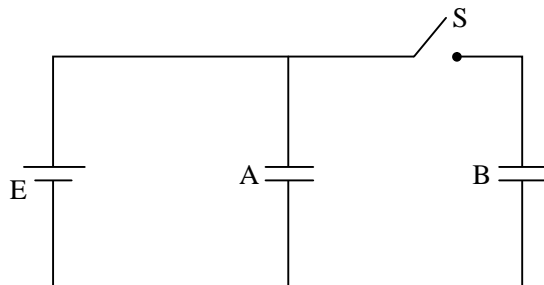

- Sol.** Net capacitance before filling the gap with dielectric slab is given by  
 $C_{\text{initial}} = A + B \dots(i)$   
 Net capacitance at here filling the gap with dielectric slab of dielectric constant  $C_{\text{final}} = A + KB = K(A + B) \dots(ii)$   
 $C_{\text{final}} = K(A + B) \dots(ii)$

Energy stored by capacitor is given by  $U = \frac{Q^2}{2C}$

So energy stored in capacitor

Combination before introduction of dielectric slab  $U_{\text{initial}} = \frac{Q^2}{(A + B)}$

Energy stored in combination after introduction of dielectric slab

$$U_{\text{final}} = \frac{Q^2}{K(A + B)}$$

Ratio of energy stored  $\frac{U_{\text{initial}}}{U_{\text{final}}} = \frac{K}{1}$

#### SECTION D

- Q.23** Asha's mother read an article in the newspaper about a disaster that took place at Chernobyl. She could not understand much from the article and asked a few questions from Asha regarding the article. Asha tried to answer her mother's questions based on what she learnt in Class XII Physics [4]

- (a) What was the installation at Chernobyl where the disaster took place? What, according to you, was the cause of this disaster?  
 (b) Explain the process of release of energy in the installation at Chernobyl.  
 (c) What according to you, were the values displayed by Asha and her mother?

- Sol.** (a) "Oh April 1986, the world's worst nuclear accident happened at the chernobyl. Plant near pripyat ukrain in the soviet union. An explosion and fire in the No. 4 reactor sent radioactivity into the atmosphere  
 (c) the value displayed by the Asha is that she is caring and having helping nature towards here mother. the value displayed by Asha's mother is that she has no idea the out burst take place in chemobyl (ukrain) but she has the curiosity about the incident that take place on April 26, 1986, at the chernobyl plant near Priyat, Ukrain, in the soviyat union.

**SECTION E**

- Q.24** (a) Derive an expression for the electric field  $E$  due to a dipole of length  $2a$  at a point distant  $r$  from the centre of the dipole on the axial line.  
 (b) Draw a graph of  $E$  versus  $r$  for  $r \gg a$ .  
 (c) If this dipole were kept in a uniform external electric field  $E_0$ , diagrammatically represent the position of the dipole in stable and unstable equilibrium and write the expressions for the torque acting on the dipole in both the cases. [5]

**OR**

- (a) Use Gauss's theorem to find the electric field due to a uniformly charged infinitely large plane thin sheet with surface charge density  $\sigma$ .  
 (b) An infinitely large thin plane sheet has a uniform surface charge density  $+\sigma$ . Obtain the expression for the amount of work done in bringing a point charge  $q$  from infinity to a point, distance  $r$ , in front of the charged plane sheet. [5]

**Sol.** Electric field intensity due to as electric dipole

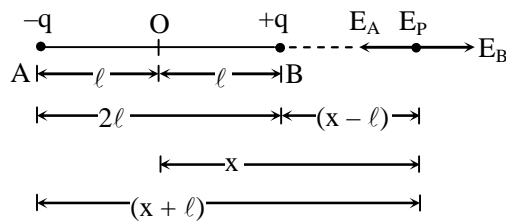

(a) Dipole at a point on the axial wire :

we have to calculate the field intensity ( $E$ ) at a point P on the axial line of the dipole and at a distance  $OP = x$  from the centre O of the dipole.

Resultant electric field intensity at the point P,  $E_P = E_A + E_B$

The vectors  $E_A$  and  $E_B$  are collinear and opposite.

$$\therefore E_P = E_B - E_A$$

$$\text{Here, } E_A = \frac{1}{4\pi\epsilon_0} \cdot \frac{q}{(x+l)^2} \text{ and } E_B = \frac{1}{4\pi\epsilon_0} \cdot \frac{q}{(x-l)^2}$$

$$\therefore E_P = \frac{1}{4\pi\epsilon_0} \left[ \frac{q}{(x-l)^2} - \frac{q}{(x+l)^2} \right] = \frac{1}{4\pi\epsilon_0} \cdot \frac{4qlx}{(x^2 - l^2)^2}$$

$$\text{Hence, } E_P = \frac{1}{4\pi\epsilon_0} \cdot \frac{2px}{(x^2 - l^2)^2} \quad [\because p = q \times 2l]$$

$$\text{In vector form, } E_P = \frac{1}{4\pi\epsilon_0} \cdot \frac{2px}{(x^2 - l^2)^2}$$

If dipole is short, i.e.,  $2l \ll x$ , then

$$E_P = \frac{2|P|}{4\pi\epsilon_0 x^3} \quad \dots(i)$$

The direction of  $E_P$  is along BP produced clearly,  $E_P \propto \frac{1}{x^3}$

(b) graph of E versus r for  $r \gg a$

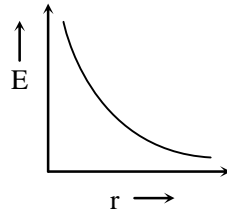

(c) torque on an electric dipole in uniform electric field :-

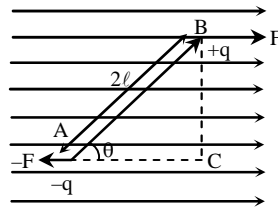

consider an electric dipole consisting of two charges  $-q$  and  $+q$  placed in a uniform external electric field of intensity  $E$ . The dipole moment  $P$  makes an angle  $\theta$  with the direction of the electric field.

The net force is zero. Since, the two forces are equal in magnitude and opposite in direction and act at different points therefore they constitute a couple. A net torque  $\tau$  acts on the dipole about an axis passing through the mid-point of the couple. Now  $\tau = \text{Either force} \times \text{perpendicular distance BC between the parallel force } qE(2l \sin \theta)$

$$\tau = (q \times 2l) E \sin \theta \text{ or } \tau = pE \sin \theta$$

In vector notation,  $\tau = p \times E$

SI unit of torque is newton-meter (N-m) and its dimensional formula is  $[ML^2T^{-2}]$

**Case-I :** If  $\theta = 0^\circ$ , then  $\tau = 0$

The dipole is in stable equilibrium.

**Case-II :** If  $\theta = 90^\circ$ , then  $\tau = PE$  (maximum value)

The torque acting on dipole will be maximum.

**Case-III :** If  $\theta = 180^\circ$ , then  $\tau = 0$

The dipole is in unstable equilibrium

**OR**

(a) Fig. : Gaussian surface for a thin infinite plane sheet of uniform charge density

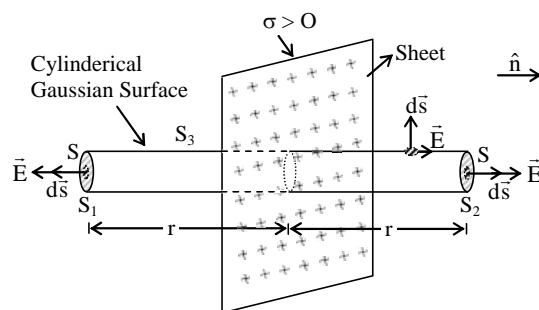

Let  $\sigma$  be the surface charge density of the sheet. From symmetry,  $E$  on either side of the sheet must be perpendicular to the plane of the sheet, having same magnitude at all points equidistant from the sheet. We take a cylindrical cross-sectional area  $A$  and length  $2r$  as the Gaussian surface.

On the curved surface of the cylinder  $E$  and  $\hat{n}$  are perpendicular to each other. Therefore flux through curved surface = 0. Flux through the flux surface =  $EA + EA = 2EA$

$\therefore$  Total electric flux over the centre surface of cylinder  $\phi_E = 2EA$

Total charge enclosed by the cylinder,  $q = \sigma A$  acc. to Gauss' law,  $\phi_E = \frac{q}{\epsilon_0}$

$$\therefore 2EA = \frac{\sigma A}{\epsilon_0} \text{ or } E = \frac{\sigma}{2\epsilon_0}$$

(b) Let  $V_0$  be the potential on the surface at sheet that at a distance  $r$  from it

$$dV = \vec{E} \cdot d\vec{r}$$

$$V_0 - V = \frac{\sigma}{2\epsilon_0} r$$

$$V = V_0 - \frac{\sigma}{2\epsilon_0} r$$

**Q.25** A device 'X' is connected to an ac source  $V = V_0 \sin \omega t$ . The variation of voltage, current and power in one cycle is shown in the following graph : [5]

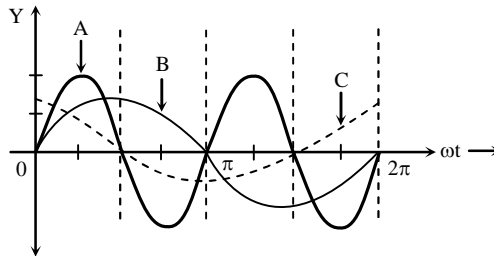

- Identify the device 'X'.
- Which of the curves A, B and C represent the voltage, current and the power consumed in the circuit ? Justify your answer.
- How does its impedance vary with frequency of the ac source ? Show graphically.
- Obtain an expression for the current in the circuit and its phase relation with ac voltage.

**OR**

- Draw a labelled diagram of an ac generator. Obtain the expression for the emf induced in the rotating coil of  $N$  turns each of cross-sectional area  $A$ , in the presence of a magnetic field  $\vec{B}$ .
- A horizontal conducting rod 10 m long extending from east to west is falling with a speed  $5.0 \text{ ms}^{-1}$  at right angles to the horizontal component of the Earth's magnetic field,  $0.3 \times 10^{-4} \text{ Wb m}^{-2}$ . Find the instantaneous value of the emf induced in the rod.

**Sol.**

- Device 'x' is a capacitor
- Curve a shows power consumption over a full cycle, curve 'B' shows voltage and curve 'C' show current  
As in a perfect capacitor the current leads the voltage by a phase angle of  $\pi/2$ .

$$(c) z = x_C = \frac{1}{\omega_C}$$

$$x_C = \frac{1}{2\pi f_C}$$

$$x_C \propto \frac{1}{f}$$

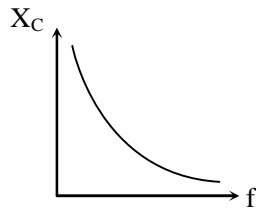

(d) AC through capacitor :- Let on consider a capacitor with capacitance C be connected to an AC source with an emf having instantaneous value

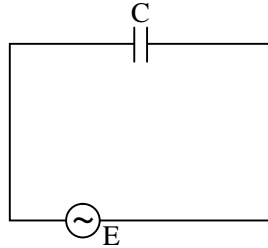

$$E = E_0 \sin \omega t \quad \dots(i)$$

Due to this emf, charge will be produced and it will charge the plates of capacitor with positive and negative charge. If potential difference across the plates of capacitor is V then

$$V = \frac{q}{C} \text{ or } q = CV$$

The instantaneous value of current in the circuit

$$\begin{aligned} I &= \frac{dq}{dt} = \frac{d(CE)}{dt} \quad (\because V = E) \\ &= \frac{d}{dt} (CE_0 \sin \omega t) \quad (\because E = E_0 \sin \omega t) \\ &= CE_0 \cos \omega t \times \omega \\ &= \frac{E_0}{1/\omega_C} \cos \omega t \quad [\because \cos \omega t = \sin(\pi/2 + \omega t)] \end{aligned}$$

$$I = \frac{E_0}{1/\omega_C} \sin(\omega t + \pi/2) \quad \dots(ii)$$

I will be maximum when  $\sin(\omega t + \pi/2) = 1$  so that  $I = I_0$

where, peak value of current  $I_0 = \frac{E_0}{1/\omega_C}$

$$I = I \sin (\omega t + \pi/2) \quad \dots(iii)$$

from (i) & (iii) it is clear current leads the voltage by a phase angle of  $\pi/2$  ( $a_0$ )

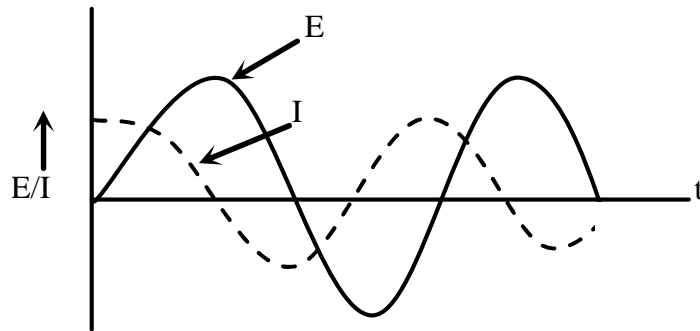

OR

(a) AC generator :-

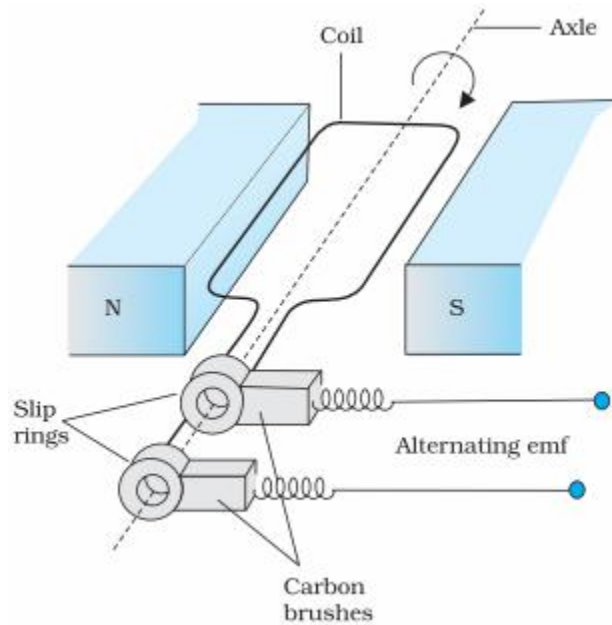

Let at any instant total magnetic flux link with the arrature will is given G.  
(Where,  $\theta = \omega t$  is the angle made by area vector of coil with magnetic field.)

$$\phi = NBA \cos\theta = NBA \cos \omega t$$

$$\therefore \frac{d\phi}{dt} = -NBA \omega \sin \omega t$$

$$- \frac{d\phi}{dt} = NBA \omega \sin \omega t$$

By Faraday's law of EMI,  $e = - \frac{d\phi}{dt}$

induced emf in will is given by,

$$e = NBA \omega \sin \omega t$$

$$e = e_0 \sin \omega t$$

Where emf in will is given by,

$$e = NBA \omega \sin \omega t$$

$$e = e_0 \sin \omega t$$

where,  $e_0 NBA \omega =$  peak value of induced emf

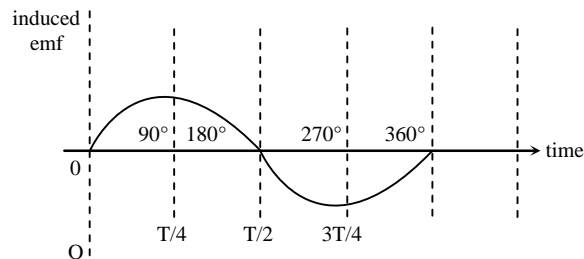

The mechanical energy spent in rotating the coil in magnetic field appears in form of electrical energy.

(b)

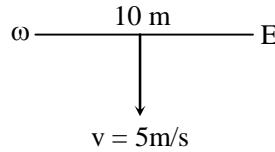

Given velocity of straight rod  $v = 5\text{m/s}$  horizontal component of the earth's magnetic field

$B = 0.30 \times 10^{-4} \text{ wb/m}^2$  length of wire  $\ell = 10 \text{ m}$

So the emf induced in the wire is given by  $e = B\ell v \sin \theta$  ( $\theta = 90^\circ$ )

$e = 0.30 \times 10^{-4} \times 10 \times 5$  ( $\therefore$  wire is falling at right angle to the earth horizontal magnetic field component)

$e = 1.5 \times 10^{-3} \text{ volt}$

air from west to east (Acc to Fleming's right hand rule)

**Q.26**

(a) Define wavefront. Use Huygens' principle to verify the laws of refraction.

(b) How is linearly polarised light obtained by the process of scattering of light? Find the Brewster angle for air – glass interface, when the refractive index of glass = 1.5 [5]

**OR**

(a) Draw a ray diagram to show the image formation by a combination of two thin convex lenses in contact. Obtain the expression for the power of this combination in terms of the focal lengths of the lenses.

(b) A ray of light passing from air through an equilateral glass prism undergoes minimum deviation when the angle of incidence is  $\frac{3}{4}$ th of the angle of prism. Calculate the speed of light in the prism.

**Sol.**

Wave front :- where light is emitted from a source, then the particles

(a) present around it begins to vibrate, the locus at all such particles which are vibrating in the same phase is termed as wavefront

Laws of refraction :- Suppose when disturbance from point P on incident wave front reaches point P on the refracted wavefront the disturbance from point Q reaches the point Q or the refracting surface XY.

Since, A'Q'P' represents the refracted wave front the time takes by light to travel from a point on incident wave front to the corresponding point on refracted wave front would always be the same. Now, time taken by light to go from r to Q' will be

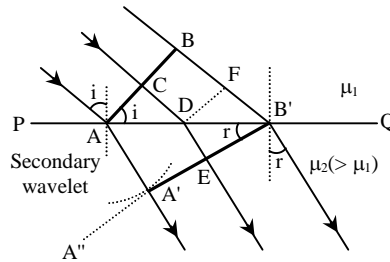

$$t = \frac{Qk}{c} + \frac{kQ'}{v} \quad \dots(i)$$

(where  $c$  and  $v$  are the velocities of light in two medium)

In right angled  $\Delta AQk$ ,  $\Delta QAk = i$

$$Qk = Ak \sin i \quad \dots(ii)$$

In right angled  $\Delta P'Q'$ ,  $\Delta Q'P'k = r$ ,

$$KQ' = KP' \sin r \quad \dots(iii)$$

substituting eq. (ii) and (iii) in eq. (i), we get

$$t = \frac{Ak \sin i}{c} + \frac{KP' \sin r}{v}$$

$$t = \frac{Ak \sin i}{c} + \frac{(AP' - Ak) \sin r}{v}$$

$$\text{or } t = \frac{AP'}{v} \sin r + \left( \frac{\sin i}{c} - \frac{\sin r}{v} \right) Ak \dots \text{(iv)}$$

The rays from different points on the present wave front will take the same time to reach the corresponding points on the refracted wave front i.e., given by equation (iv) is independent of Ak. will happens so, if

$$\frac{\sin i}{c} - \frac{\sin r}{v} = 0$$

$$= \frac{\sin i}{\sin r} = \frac{c}{v}$$

$$\text{However, } \frac{c}{v} = n$$

This is the shell's law for refraction of light.

(b) polarisation by scattering :- polarisation also occurs when light is scattered while travelling through of medium. When light strikes the atoms of a material it will often set the electrons of those atoms into vibrations the vibrating electrons then produce their own electromagnetic wave that is radiated outward in all directions. These vibrating electrons produce another electromagnetic wave that is once more radiated outward in all directions. This absorption and refraction of light waves causes the light to be scattered about the medium.

This process of scattering contributes to the blueness of our sky. This scattered light is partially polarized.

Here, refractive index  $\mu = 1.5$ ,  $i_B = ?$

from Brewster's law  $\tan i_B = \mu = 1.5$

$$i_B = \tan^{-1}(1.5) = 56.3^\circ$$

**OR**

(a) Ray diagram

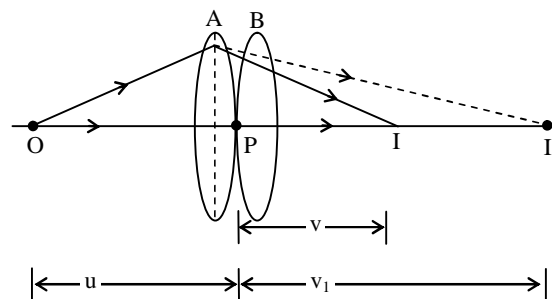

Consider two lenses A and B of focal length  $f_1$  and  $f_2$  placed in contact with each other. An object is placed at a point O beyond the focus of the first lens A. The first lens produces an image at  $I_1$  (virtual image) which serves as a virtual object for the second lens B, producing the final image at I.

Since the lenses are thin, we assume the optical centres (P) of the lenses to be co-incident for the image formed by the first lens A, we obtain



$$\frac{1}{v_1} - \frac{1}{u} = \frac{1}{f_1} \quad \dots(i)$$

For the image formed by the second lens B, we obtain

$$\frac{1}{v} - \frac{1}{v_1} = \frac{1}{f_2} \quad \dots(ii)$$

adding eq. (i) and (ii) we obtain

$$\frac{1}{v} - \frac{1}{u} = \frac{1}{f_2} + \frac{1}{f_2} \quad \dots(iii)$$

If the two lens system is regarded as equivalent to a single lens of focal length  $f$ , we have,

$$\frac{1}{v} - \frac{1}{u} = \frac{1}{f} \quad \dots(iv)$$

from eq. (iii) and (iv), we obtain

$$\boxed{\frac{1}{f} = \frac{1}{f_1} + \frac{1}{f_2}} \quad \dots(v)$$

For overall this lenses of focal lengths  $f_1, f_2, f_3, \dots$  the effective focal length is

$$\boxed{\frac{1}{f} = \frac{1}{f_1} + \frac{1}{f_2} + \frac{1}{f_3} + \dots} \quad \dots(vi)$$

In terms of power, eq. (vi) can be written as

$$P = P_1 + P_2 + P_3 + \dots$$

(b) Given angle of prism (A) =  $60^\circ$

$$\begin{aligned} \text{angle of incidence (i)} &= \frac{3}{4}A \\ &= \frac{3}{4} \times 60 \\ &= 45^\circ \end{aligned}$$

$$i = 45^\circ$$

for minimum deviation ( $i = e, r_1 = r_2$ )

$$\delta_m = i + e - A$$

$$\delta_m = 2i - A$$

$$\delta_m = 2 \times 45^\circ - A = 90^\circ - 60^\circ = 30^\circ$$

$$\delta_m = 30^\circ, i = 45^\circ, A = 60^\circ$$

$$\text{Since } \mu = \frac{\sin\left(\frac{\delta_m + A}{2}\right)}{\sin\frac{A}{2}} = \frac{\sin\left(\frac{30 + 60}{2}\right)}{\sin\frac{60}{2}}$$

$$\mu = \frac{\sin 45^\circ}{\sin 30^\circ} = \frac{1}{\frac{1}{\sqrt{2}}} = \frac{2}{1}$$

$$\mu = \sqrt{2}$$

$$\therefore \mu = \frac{c}{v} \quad (c = 3 \times 10^8 \text{ m/s})$$

$$\text{Speed of light in prism (v)} = \frac{3 \times 10^8}{\sqrt{2}} \text{ m/s}$$