

2019



माध्यमिक शिक्षा मण्डल, मध्यप्रदेश, भोपाल

24 पृष्ठीय

परीक्षार्थी द्वारा भरा जावे ↓

परीक्षा का विषय	विषय कोड	परीक्षा का माध्यम
PHYSICS	2 1 0	ENGLISH

परीक्षार्थी द्वारा भरा जावे ↓

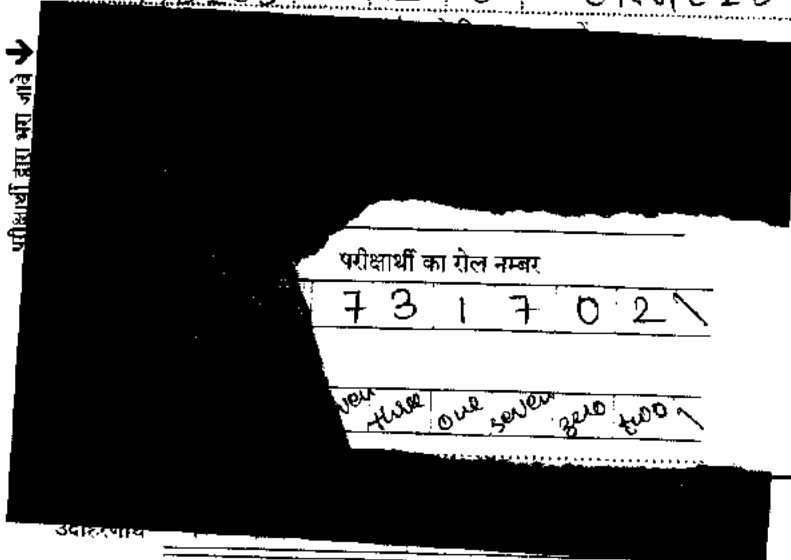

परीक्षार्थी का रोल नम्बर

7317021

New Hall One series 2010-11

एक एक दो चार तीन नौ पाच छः आठ

केन्द्राध्यक्ष/सहायक केन्द्राध्यक्ष एवं पर्यवेक्षक द्वारा भरा जावे ↓

क - पूरक उत्तर पुस्तिकाओं की संख्या अंकों में 3 शब्दों में Three

ख - परीक्षार्थी का कक्ष क्रमांक Hall-B

ग - परीक्षा का दिनांक 11/03/2019

परीक्षा का नाम एवं परीक्षा केन्द्र क्रमांक की मुद्रा

सहायक केन्द्राध्यक्ष परीक्षा केन्द्र क्र. 671054

पर्यवेक्षक का नाम एवं हस्ताक्षर

S.C. Chaturvedi

केन्द्राध्यक्ष/सहायक केन्द्राध्यक्ष के हस्ताक्षर

S. Sarakia

परीक्षक एवं उपमुख्य परीक्षक द्वारा भरा जावे ↓

परीक्षक एवं उपमुख्य परीक्षक द्वारा भरा जावे ↓

प्रमाणित किया जाता है कि मूल्यांकन के समय पूरक उत्तर पुस्तिकाओं की संख्या उपरोक्तानुसार सही पाई हो। लो क्रॉफ्ट स्टीकर क्षतिग्रस्त नहीं पाया गया तथा अन्दर के पृष्ठों के अनुरूप मुख्य पृष्ठ पर अंकों की प्रविष्टी एवं अंकों का योग सही है।

निर्धारित मुद्रा : नाम, पदनाम, मोबाईल नम्बर, परीक्षक क्रमांक एवं पदांकित संस्था के नाम की मुद्रा लगाएं।

उप मुख्य परीक्षक के हस्ताक्षर एवं निर्धारित मुद्रा

S.C. Chaturvedi (Principal)  
Head Val. No. 74785

परीक्षक के हस्ताक्षर एवं निर्धारित मुद्रा

A. V. Pandey  
74750

केवल परीक्षक द्वारा भरा जावे।  
प्रश्न क्रमांक के सम्मुख प्राप्तांकों की प्रविष्टी करें।

प्रश्न क्रमांक	पृष्ठ क्रमांक	प्राप्तांक (अंकों में)
1		✓
2		✓
3		✓
4		✓
5		✓
6		✓
7		✓
8		✓
9		✓
10		✓
11		✓
12		✓
13		✓
14		✓
15		✓
16		✓
17		✓
18		✓
19		✓
20		✓
21		✓
22		✓
23		✓
24		✓
25		✓
26		✓
27		✓
28		✓
कुल प्राप्तांक		में

Cr

3

$$\boxed{\quad} + \boxed{\quad} = \boxed{c \quad}$$

योग पृष्ठ                      पृष्ठ 3 के अंक                      अंक



### Question - 01

(a) ~~(iv)~~ LED. (iv) Photo diode.

(b) ~~(iii)~~  $\frac{\Delta I_c}{\Delta I_b}$

(c) (i)  $1.32 \times 10^{-27} \text{ kg} \times \text{m/s}$

(d) (iii) Insulator.

(e) (ii) 9 km.

### Question - 2

(a) Infinite.

(b)  $9.1 \times 10^{-31} \text{ kg}$

(c) zero.

(d) zero.

(e) Negative (-ve)

4

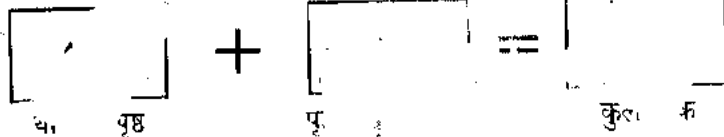

### Question 3

Column A

Column B

- |     |   |  |
|-----|---|--|
| (a) | Potential energy of dipole  | (vii) <del><math>\rho E (1 - \cos \theta)</math></del> |
| (b) | Ultraviolet rays  | (vi) As a Germ killer.                                 |
| (c) | Infrared rays   | (iv) In photography in dark.                           |
| (d) | Intensity of <sup>mag. field of</sup> current carrying solenoid at the centre | (iii) <del><math>\mu_0 n I</math></del>                |
| (e) | Intensity of mag. field at one end of current carrying solenoid.              | (i) $\frac{\mu_0 n I}{2}$                              |

5

[ ]  
योग पृष्ठ

+

[ ]  
पृष्ठ 5 के अंक

=

[ ]  
कुल अंक



### Question 4

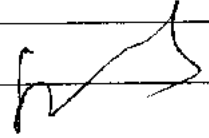

- (a) Neon lamp shows absorption spectrum.
- (b) NOR gate represent Boolean expression  $y = \overline{A+B}$
- (c) Core of transformer is laminated so as to minimise the energy & heat loss due to eddy current.
- (d) Simple microscope is also called reading lens.
- (e) Resolving power of microscope depends inversely on the wavelength of light used.

$$\text{Resolving Power} = \frac{d}{1.22\lambda}$$

6

$\square$   
योग पूर्व पृष्ठ

+

$\square$   
पृष्ठ 6 के अंक

=

$\square$   
कुल अ...



## Question 5

OR

### Remote Sensing :-

Obtaining information about the characteristics such as size, weather, colour, etc without physically touching the source of information (ex- earth) is called Remote Sensing.

B

S

E

→ Remote sensing is done by polar satellites.

## Question - 6

OR

### Conjugate foci

Conjugate foci are a pair of point on principle axis such that when object is placed at one point the image is obtained at another point. Same thing happens when the object is placed on other point the image of object is observed at the previous 1<sup>st</sup> point. This is

7

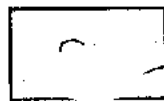

योग पूर्व पृष्ठ

+



पृष्ठ 7 के अंक

=



कुल अंक



called conjugate foci.

## Question - 7

### Laws of Photoelectric Effect :-

- B  
S  
L
- (1) For ejection of  $e^-$  by photo sensitive metal the incident light should have a particular minimum frequency ( $\nu_0$ ) required for ejection of  $e^-$  and that is known as "Threshold frequency".
  - (2) The no. of electrons ejecting from metal is directly proportional to the intensity of incident photons or radiation.

No. of electrons  $\propto$  Intensity

8

$$\boxed{\text{या. पूर्व पृष्ठ}} + \boxed{\text{अंक}} = \boxed{\text{अंक}}$$



BOARD OF SECONDARY EDUCATION, MADHYA PRADESH

### Question - 8

OR

#### Characteristics of Laser Rays:-

(1) Laser beams / rays are highly coherent in nature.

(2) Laser beams are monochromatic.

B, S, E All the photons in laser beam are of same frequency and amplitude.

(2) All the rays / radiation in laser beam are parallel to each other.

### Question - 9

Relation between Electric Current and Drift velocity.

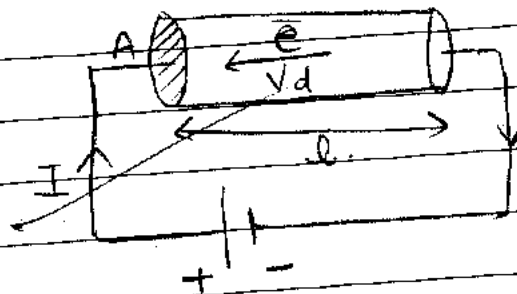





10

योग पूर्व पृष्ठ

+

पृष्ठ 10 के अंक

=

कुल अंक



Now putting the value of equation (1) and (3) in equation (2) we get.

$$I = \frac{Q}{t} = \frac{n \bar{e} A l}{l / v_d}$$

$$I = n \bar{e} A l v_d \rightarrow (4)$$

where,  $I$  = current in circuit  
 $n$  = no. of  $\bar{e}$  per unit volume  
 $A$  = area of cross section  
 $l$  = length of wire  
 $v_d$  = drift velocity.

So, by equation (4) i.e.  $I = n \bar{e} A l v_d$  we can say that

$$I \propto v_d$$

i.e. current is directly proportional to drift velocity.

11

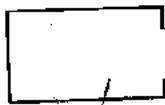

योग पूर्व पृष्ठ

+

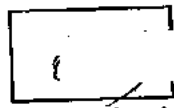

पृष्ठ 11 के अंक

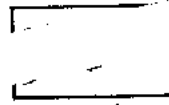

कुल अंक



## Question-10

OR

### Super conductors

:- Super conductors are the metals which offer zero resistance to the flow of current at temperature 0 K. (kelvin)

→ Super conductors show high value to conductivity.

→ But with increase in temperature they develop a resistance but even then they can be used as efficient conductors.

### Uses of superconductors :-

(i) Super conductors can be used in heavy machines so as to minimise the loss of energy in form of heat as they offer minimum resistance.

(ii) Super conductors are also use in making of strong permanent magnets.

12



योग पूर्व पृष्ठ

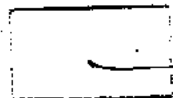

पृष्ठ 12 के अंक

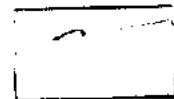

कुल अंक



प्रश्न क्र.

### Question : 11

Relation between critical angle and refractive index.

Critical Angle ( $i_c$ )  $\rightarrow$  It is the minimum angle of incidence for which the refracted ray goes parallel to the surface of medium and "angle of refraction is  $90^\circ$ ".

#### Condition

Ray of light should go from denser medium to rarer medium.

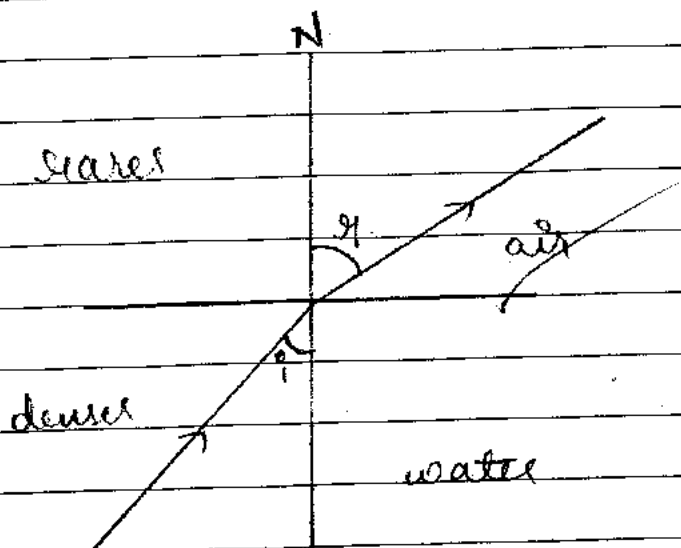

(I) When  $i$  is less than  $i_c$

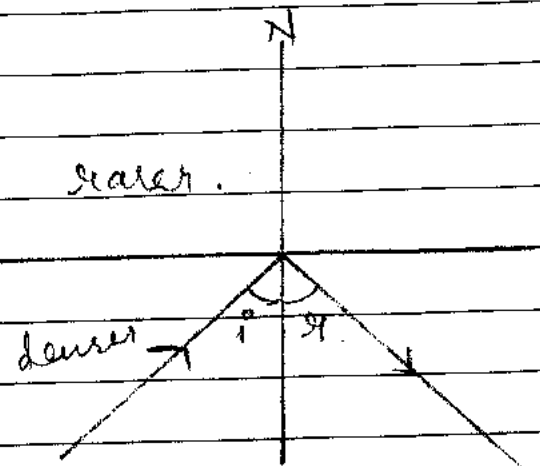

(II) When  $i$  is greater than  $i_c$ .

13



योग पूर्व पृष्ठ

+

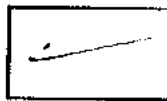

पृष्ठ 13 के अंक

=

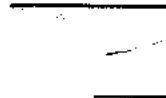

पुनः अंक



rarer

$\mu_a$

denser

$\mu_w$

Here,  $i = i_c$   
 $r = 90^\circ$

### Relation

Assume that the angle of incidence is equal to critical angle then.

According to Snell's Law,

$$\text{Refractive Index} = \mu_w \mu_a = \frac{\sin i}{\sin r}$$

$$\left[ \begin{array}{l} \sin i = \sin i_c \\ \sin r = \sin 90^\circ \end{array} \right]$$

$\mu_w \mu_a =$  as ray goes from water to air

14

$$\boxed{\phantom{000}} + \boxed{\phantom{000}} = \boxed{\phantom{000}}$$

योग पूर्व पृष्ठ                      14 क अंक                      कुल अंक



प्रश्न क्र.

$$\text{So, } \mu_{12} = \frac{\sin i_c}{\sin 90^\circ}$$

$$[\sin 90 = 1]$$

$$\mu_{12} = \frac{\sin i_c}{1}$$

$$\boxed{\mu_{12} = \frac{1}{\sin i_c}}$$

B  
S  
E

sol: ~~So,~~  $\frac{1}{\mu_{12}} = \sin i_c$

$$\boxed{\mu_{12} = \frac{1}{\sin i_c}}$$

So, Refractive Index is inversely proportional to critical angle.

15

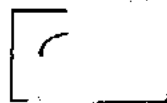

योग पूर्व पृष्ठ

+

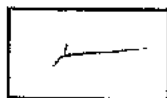

पृष्ठ 15 के अंक

=

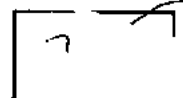

कुल अंक



## Question 12

### Refractive Index of Prism.

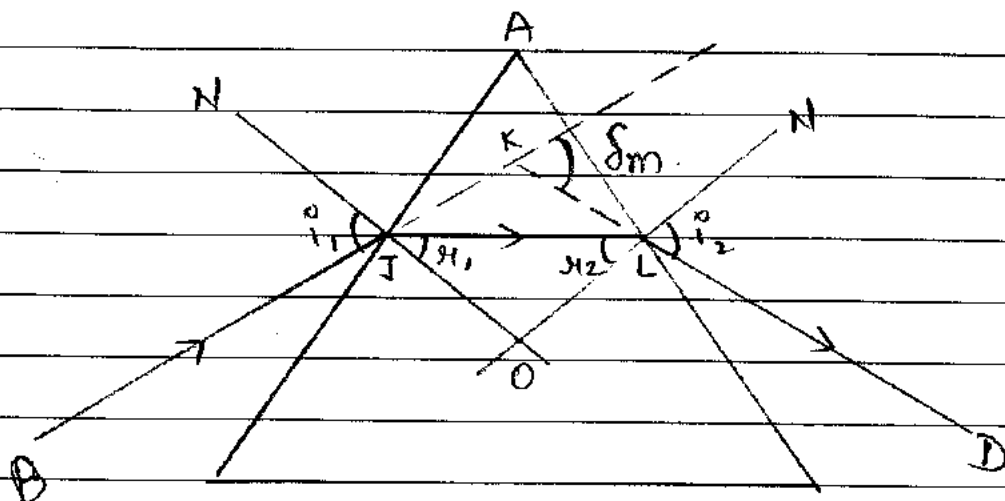

#### Theory

An incident ray BT strike the prism at angle  $i_1$  and emerges out making angle  $e_2$ .

Angle of refraction are  $r_1$  &  $r_2$ .

N is a normal drawn at prism.

$\delta_m$  here is the deviation of incident ray.

A is the angle of prism.

16

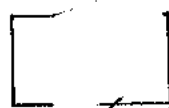

योग पूर्व पृष्ठ

+

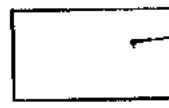

पृष्ठ 16 के अंक

=

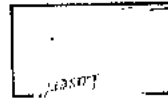

कुल अंक



प्रश्न क्र.

We know that,

$$\delta_m = \angle KJO + \angle KLO$$

(Exterior angle property)

$$\delta_m = (i_1 - u_1) + (i_2 - u_2)$$

$$\delta_m = 2i - 2u.$$

Considering the case of minimum deviation  $i_1 = i_2 = i$

$$u_1 = u_2 = u.$$

$$\therefore \delta_m = 2i - 2u \rightarrow (1).$$

Now In Quadrilateral AJOL,  $\angle AJO = \angle ALO = 90^\circ$ .

So,

$$\angle JAL + \angle JOL = 180^\circ$$

$$\angle A + \angle O = 180^\circ \rightarrow (2)$$

In  $\triangle JLO$ .

$$u_1 + u_2 + \angle O = 180^\circ \rightarrow (3)$$

Equating equation (2) & (3)

We get.

$$\angle A + \angle O = u_1 + u_2 + \angle O$$

$$2u = \angle A \rightarrow (4).$$

17

योग पूर्व पृष्ठ

+

20 17 के अंक

कुल अंक



Now putting value of eq<sup>n</sup> (4) in eq<sup>n</sup> (1)

we get

$$\delta m = 2i - A$$

$$\text{So, } i = \frac{\delta m + A}{2} \rightarrow (5)$$

We know by Snells Law that

$$\mu = \frac{\sin i}{\sin r} \rightarrow (6)$$

putting value of eq<sup>n</sup> (4) & (5) in eq<sup>n</sup> (6)  
we get

$$\mu = \frac{\sin \left( \frac{\delta m + A}{2} \right)}{\sin \left( \frac{A}{2} \right)}$$

Hence, the above expression is the formula for refractive index of prism.



18

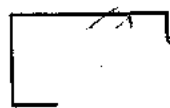

योग पूर्व पृष्ठ

+



पृष्ठ 18 के अंक

=



कुल अंक



# Question - 13

OR

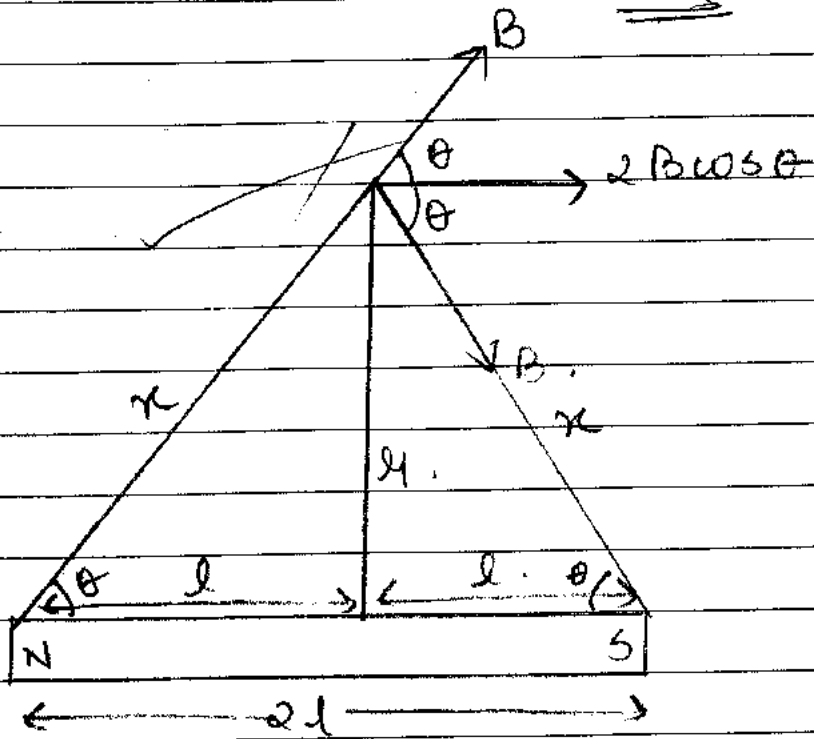

## Theory

$x$  is the equal distance from poles of bar magnet.

$y$  is the perpendicular distance.

The length of bar magnet is  $2l$ .

The mag. field of every pole is divided into components.

19



योग पूर्व पृष्ठ

+

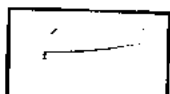

पृष्ठ 19 के अंक

=

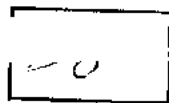

कुल अंक



60°  
sin θ components  
are cancelled.

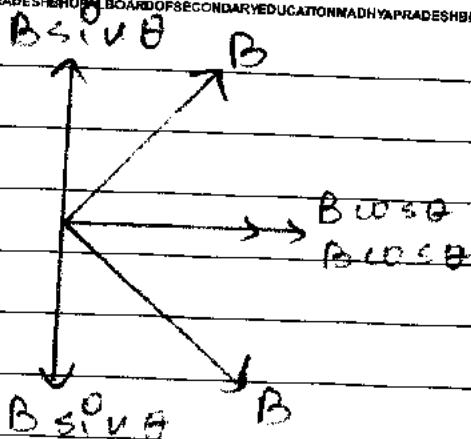

### Derivation

Here the ~~sin~~ <sup>cos</sup> θ components are added so the net magnetic field is

$$B_{net} = 2B \cos \theta$$

$$B_{net} = 2 \times \frac{\mu_0 \times m}{4\pi r^2} \times \cos \theta$$

$$= 2 \times \frac{\mu_0 \times m}{4\pi (\sqrt{r^2 + l^2})^2} \times \cos \theta$$

$$[r^2 = r^2 + l^2]$$

$$\cos \theta = \frac{l}{\sqrt{r^2 + l^2}}$$

$$B_{net} = \frac{\mu_0 \times 2m}{4\pi (r^2 + l^2)} \times \frac{l}{\sqrt{r^2 + l^2}}$$

$$= \frac{\mu_0 \times 2ml}{4\pi (r^2 + l^2)^{3/2}}$$

20

$$\boxed{\text{योग पूर्व पृष्ठ}} + \boxed{\text{पृष्ठ 20 के अंक}} = \boxed{\text{कुल अंक}}$$



प्रश्न क्र.

$$2ml = M = \text{magnetic moment}$$

$$B_{\text{net}} = \frac{\mu_0}{4\pi} \times \frac{M}{(a^2 + l^2)^{3/2}}$$

Here,  $l \ll a$

$$\text{So, } B_{\text{net}} = \frac{\mu_0}{4\pi} \times \frac{M}{a^3}$$

proved.

### Question - 14

OR

### Eddy Current :-

Whenever the metallic conductor is between a magnetic field and flux through the conductor is varying then eddy current is generated in conductor.

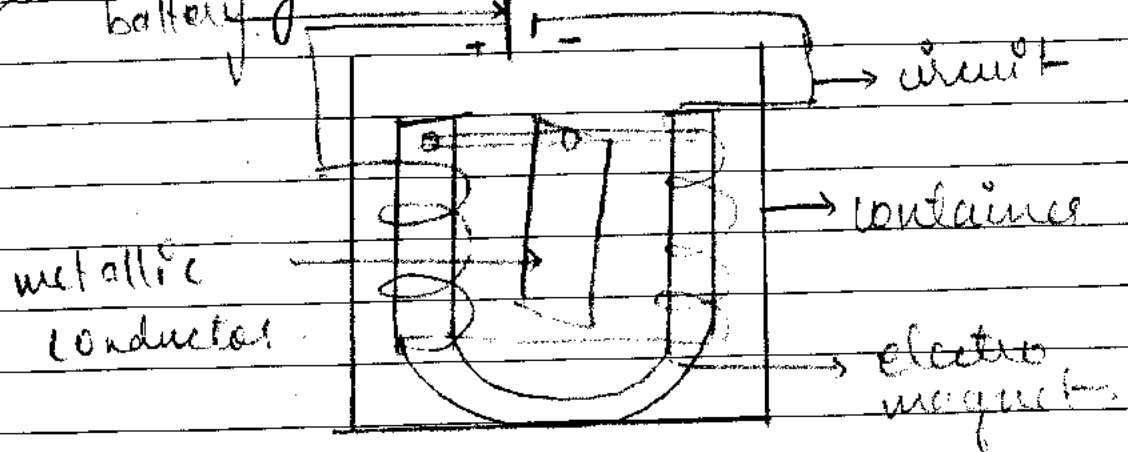

B  
S  
E

(21)

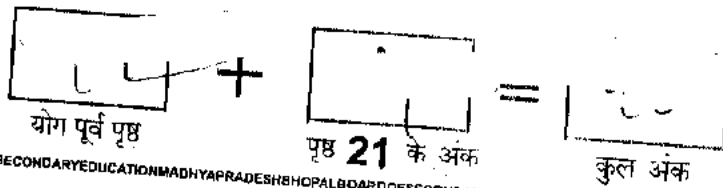

## Set up :-

A electromagnet is taken and a conductor is fixed such that it is free to move horizontally.

## Experiment

:- When the key is open and the conductor is made to oscillate it stops after some time due to air resistance.

But when the key is closed and current flow. The magnetic field is setup. Now when the conductor is made to oscillate it stops suddenly.

Observation :- This sudden stoppage of conductor is due to the generation of eddy current in the conductor which opposes the motion of conductor in magnetic field.

Uses :-

- (1) Used to make galvanometer dead beat.
- (2) Used in electric brakes.
- (3) Used in inductor furnace.
- (4) Used in induction motor.



योग पूर्व पृष्ठ

+

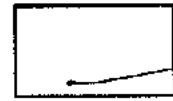

पृष्ठ 22 के अंक

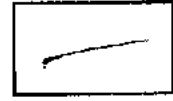

कुल अंक



### Question-15

#### Electromagnetic waves :-

The waves which are formed by the perpendicular vibrations of magnetic wave & electric wave and their direction of propagation is perpendicular to the direction of vibration.

B  
S  
E

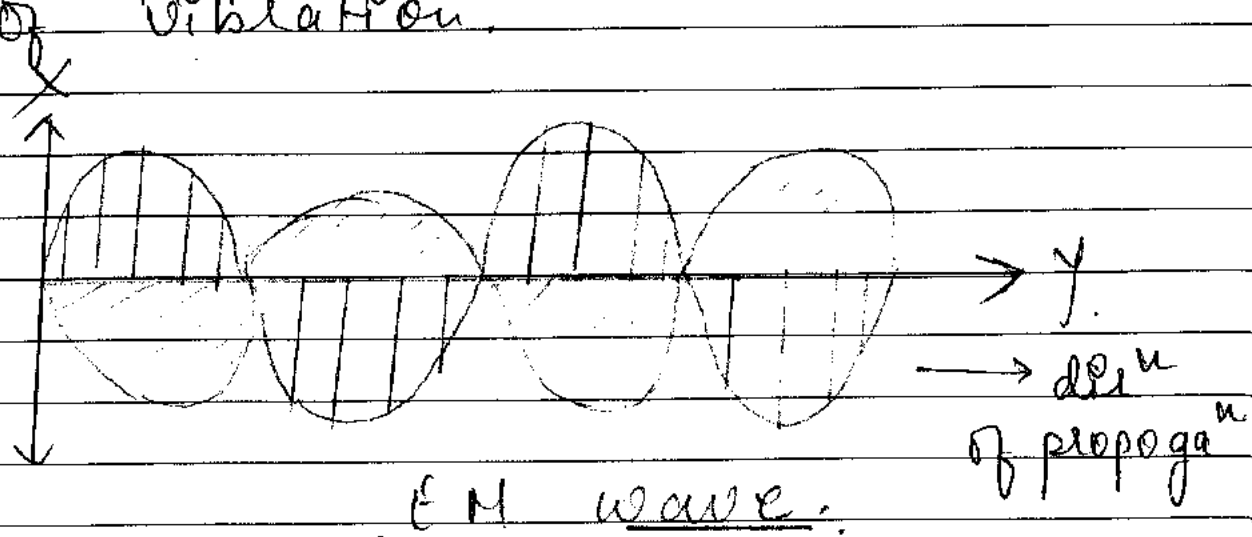

#### Characteristics :-

- (1) EM waves can travel in vacuum.
- (2) EM waves do not have phase difference.

23

$$\boxed{\phantom{00}} + \boxed{\phantom{00}} = \boxed{\phantom{00}}$$

योग पूर्व पृष्ठ                      पृष्ठ 23 अंक                      कुल अंक



Q. 2) The two component of wave i.e. electro mag. & electric and mag. component are perpendicular to each other.

(14) EM waves do not need a material medium to its propogation.

(15) EM waves travel with the speed of light i.e.  $3 \times 10^8$  m/s.

(16) The wavelength also depends on the refractive index of propogation of ray.

Question - 16

Simple Microscope                      OR

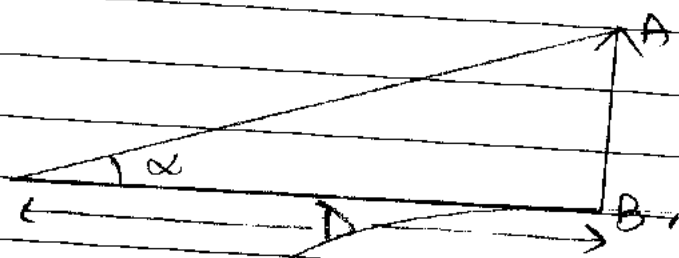

$\alpha$  = visual angle of object  
 AB = length of object  
 D = least dist of distinct

24

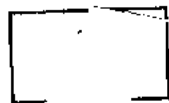

पृष्ठ

+



पृष्ठ 24 के अंक

=



कुल अंक



प्रश्न क्र.

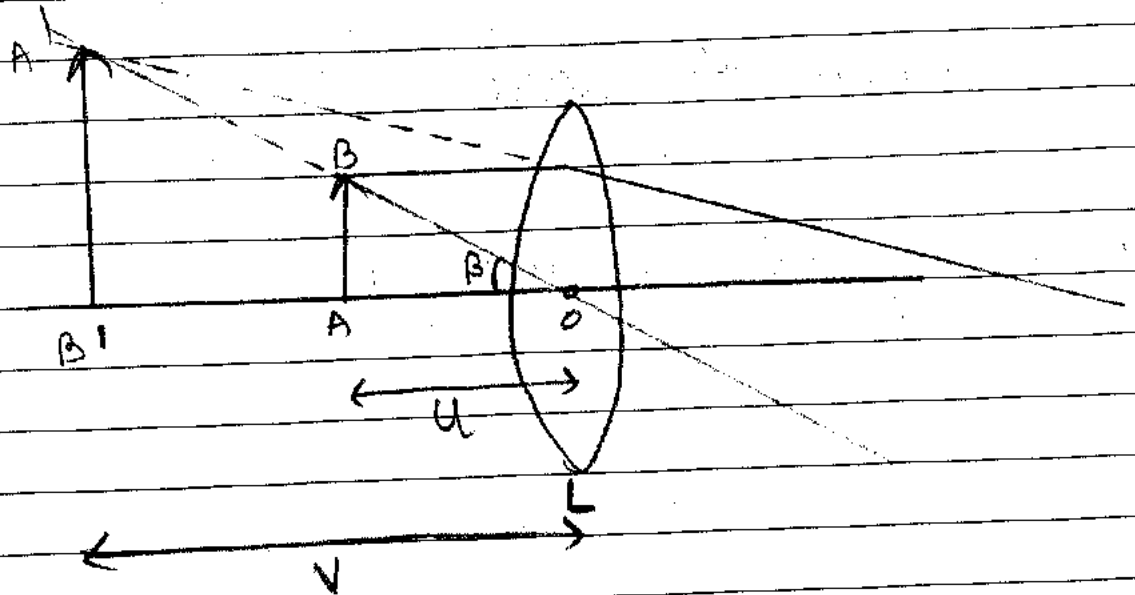

B  
S  
E

Here,  $B$  = visual angle of image.  
 $u$  = object dist.  
 $v$  = image distance.  
 $A'B'$  = length of image.  
 $L$  = lens used.

Magnification :-

Magnification is defined as the ratio of visual angle of image to the visual angle of object placed at the minimum distance of distinct vision.

$$M = \frac{\tan B}{\tan \alpha} \rightarrow (1)$$

2017



माध्यमिक शिक्षा मण्डल, मध्य प्रदेश

4 पृष्ठीय

परीक्षार्थी द्वारा भरा जावे ↓

परीक्षा का विषय

विषय कोड

परीक्षा का माध्यम

परीक्षा का दिनांक

Physics

2

1

D

English

11/03/17

स्टीकर तीर के निशान ↓ से मिलाकर लगायें

परीक्षार्थी द्वारा भरा जावे →

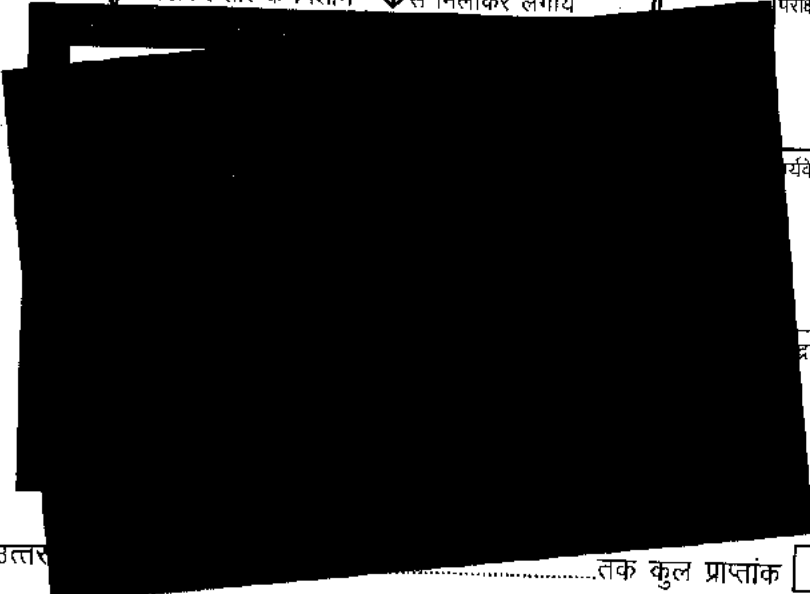

परीक्षा का नाम एवं परीक्षा केन्द्र क्रमांक की युग्म

मध्य प्रदेश माध्यमिक शिक्षा

केन्द्र क्र. 671054

पर्यवेक्षक का नाम एवं हस्ताक्षर

Bal TADAT

प्राध्यापक/सहायक केन्द्राध्यापक के हस्ताक्षर

Sonakia

मुख्य उत्तर

तक कुल प्राप्तांक [ ] + [ ] = [ ]

$$\tan \alpha = \frac{AB}{D}$$

$$\tan \beta = \frac{AB}{u}$$

Putting the value in eq<sup>n</sup> (1) we get.

$$M = \frac{AB \times -D}{-u \quad AB}$$

$$\text{So, } \boxed{M = \frac{D}{u}}$$

Magnification of simple microscope  
is  $M = \frac{D}{u}$

के अर्थ का योग



(2)

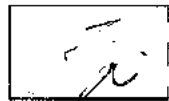

+

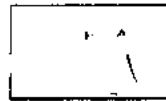

=

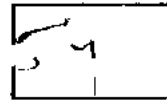

योग पूर्व पृष्ठ

पृष्ठ 2 के अंक

कुल अंक



प्रश्न क्र.

## Condition One

Image should ~~be~~ obtained at least distance of distinct vision.

So, ~~v~~  $v = D$ .

We know,

$$\frac{1}{f} = \frac{1}{v} - \frac{1}{(-u)}$$

$$\frac{1}{f} = \frac{1}{-D} + \frac{1}{u}$$

Multiply  $D$  with whole eq<sup>n</sup> we get.

$$\frac{D}{f} = -1 + \frac{D}{u}$$

$$\frac{D}{u} = \frac{D}{f} + 1$$

$$M = \frac{D}{u} = \frac{D}{f} + 1$$

## Condition 2

Image at infinity. So  $u = f$ .

$$M = \frac{D}{f}$$

3

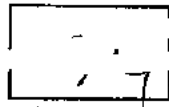

योग पूर्व पृष्ठ

+

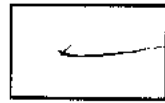

पृष्ठ 3 के अंक

=



कुल अंक



प्रश्न क्र.

## Question 17

Optical fibre :- Optical fibre is a thin wire made up of glass core and other layers of glass or plastic in its periphery. It is used in transmission of data/information in form of "light beam".

B  
S  
E

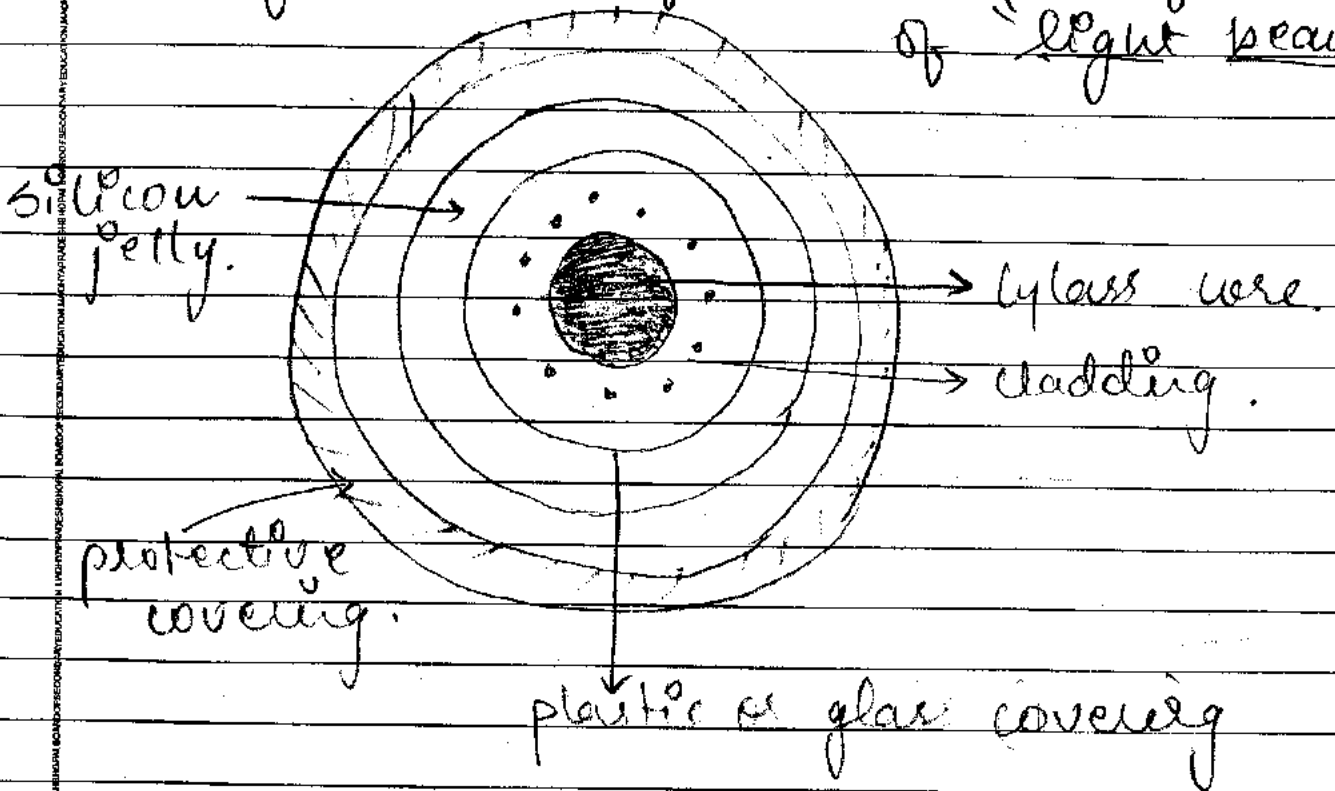

→ Core :- core of optical fibre is made up of pure glass of refractive index  $n = 1.7$ .

→ Cladding :- It is the covering of core with refractive index  $n = 1.5$ .

4

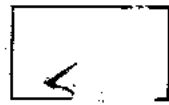

योग

+

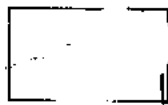

पृष्ठ 4 के अंक

=

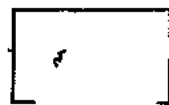

कुल 8



→ Other protective covering → covering of optical fibre is further done by silicious jelly.

\* Optical fibres have high band width and can transfer optical signal in form of light beam.

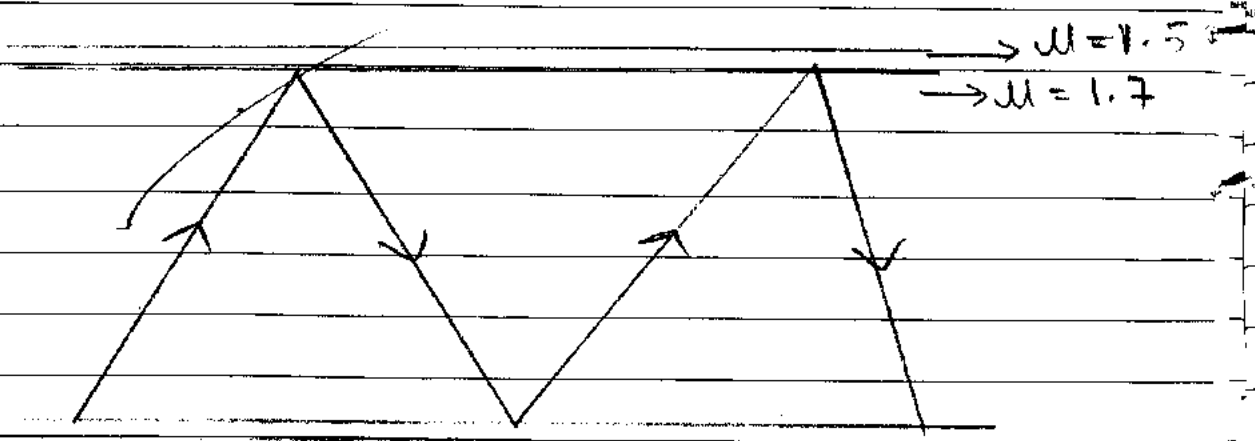

Transmission

\* Signals are transmitted by the principle of "Total Internal reflection" due to difference in refractive indices of material.



परीक्षार्थी द्वारा भरा जावे ↓

परीक्षा का विषय

विषय कोड

परीक्षा का माध्यम

परीक्षा का दिनांक

11 03 17

Physics 2 1 0 English

(नीचे दिए गए विषयों में से किसी एक को चुनिए)

परीक्षार्थी द्वारा भरा जावे →

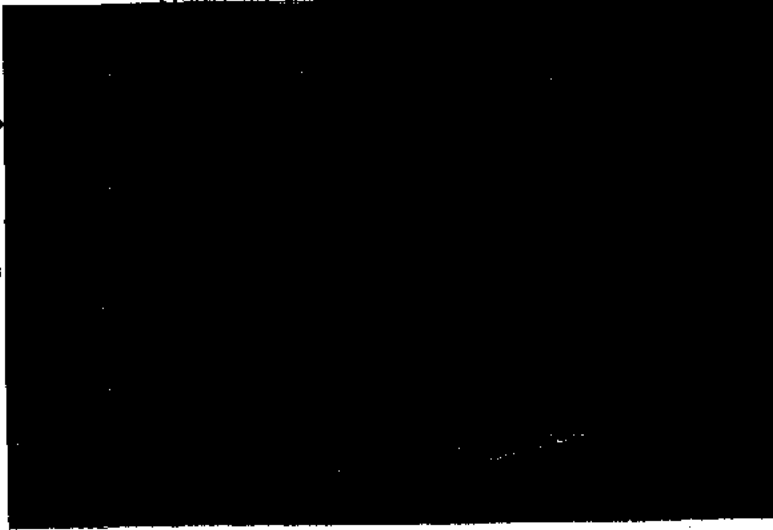

परीक्षा का नाम एवं परीक्षा केंद्र क्रमांक की मुद्रा

**मध्य प्रदेश बोर्ड**  
केंद्र क्रमांक  
671054

---

पर्यवेक्षक का नाम एवं हस्ताक्षर

---

केन्द्राध्यक्ष/सहायक केन्द्राध्यक्ष के हस्ताक्षर

**Banakia**

मुख्य उत्तर पुस्तिका के अंतिम पृष्ठ क्रमांक ..... तक कुल प्राप्तांक  +  =

### Question 18

(i) OR Gate

B  
S  
E

(ii) Symbol

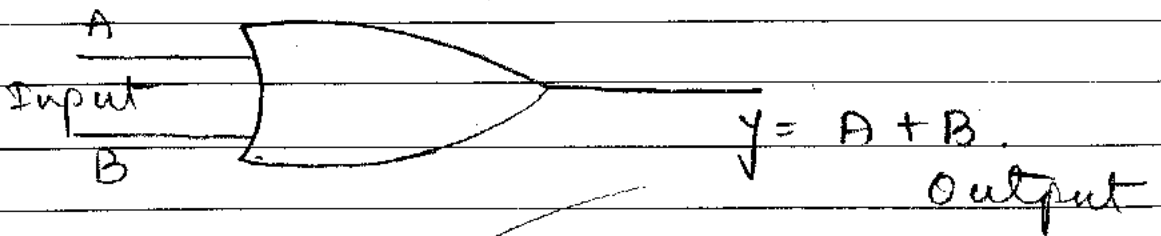

(iii) Truth Table



पृष्ठ के अंकों का योग

A	B	$y = A + B$
0	0	0
1	0	1
0	1	1
1	1	1

②



प्रश्न क्र. (iii)

Boolean Expression.  $y = A + B = B + A$

~~$y = A + B = B + A$~~

(ii) AND GATE:

(i) Symbol

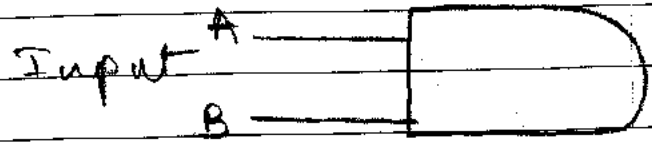

$y = A \cdot B = A \times B$ ,  
Output

(ii) Truth Table.

A	B	$Y = A \cdot B$
0	0	0
0	1	0
1	0	0
1	1	1

(iii) Boolean Expression.

$y = A \cdot B = A \times B$

B  
S  
E

3

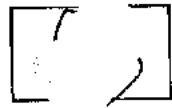

योग पूर्व पृष्ठ

+

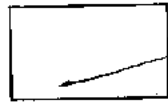

पृष्ठ 3 के अंक

=



कुल अंक



प्रश्न क्र.

## Question - 19

### RC circuit

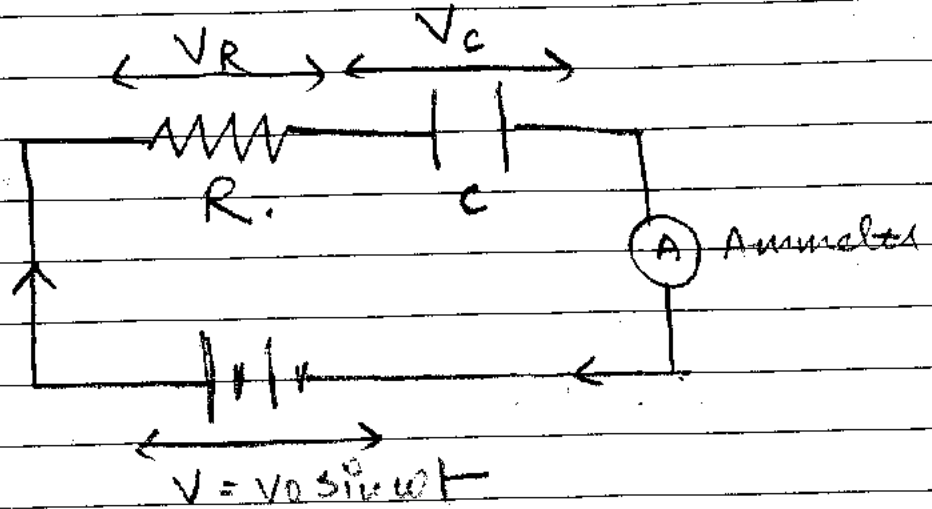

Suppose a circuit consist of a resistance and a capacitor.

The voltage is  $V = V_0 \sin \omega t$ .

The voltage across resistance =  $V_R = IR$ .

The voltage across capacitor =  $V_C = IX_C$ .

We know that the voltage of capacitor lags behind the current by phase diff of  $\pi/2$ .

④

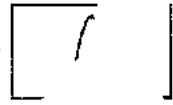

+

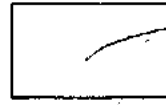

=

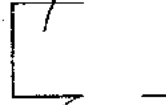

योग पूर्व पृष्ठ

पृष्ठ 4 के अंक

कुल अंक



प्रश्न क्र.

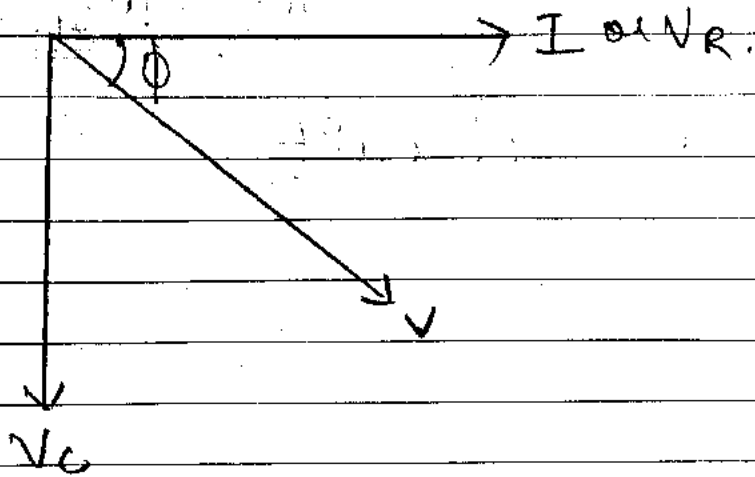

(i) Resultant voltage =  $V = \sqrt{V_R^2 + V_C^2}$

we know =  $V_R = IR$   
 $V_C = IX_C$

$$V = \sqrt{(IR)^2 + (IX_C)^2}$$

$$V = \sqrt{I^2 R^2 + I^2 X_C^2}$$

$$\frac{V}{I} = \sqrt{R^2 + X_C^2}$$

$\frac{V}{I} = R$  by ohm law but here it is denoted as Impedence and written as  $Z$ .

B  
S  
E

017



माध्यमिक शिक्षा मण्डल, मध्यप्रदेश, भोपाल

4 पृष्ठों

परीक्षार्थी द्वारा भरा जावे ↓

परीक्षा का विषय

विषय कोड

परीक्षा का माध्यम

परीक्षा का दिनांक

11 03 2017

Physics 2 1 0 English

स्टीकर तीर के निशान ↓ से मिलाकर लगाये

परीक्षा का नाम एवं परीक्षा केन्द्र क्रमांक की तुलना

हाई स्कूल परीक्षा

केन्द्र क्र. 671054

शिक्षक का नाम एवं हस्ताक्षर

*[Signature]*

प्राध्यापक/सहायक केन्द्राध्यक्ष के हस्ताक्षर

*Bonakia*

परीक्षार्थी द्वारा भरा जावे →

मुख्य उत्तर पुस्तिका के अंतिम पृष्ठ क्रमांक ..... तक कुल प्राप्तांक  +  =

(ii) Impedance =  $Z = \sqrt{R^2 + (X_c)^2}$

So,  $X_c = \frac{1}{\omega C}$

So,  $Z = \sqrt{R^2 + \frac{1}{\omega^2 C^2}}$

(iii) Phase difference ( $\phi$ ).

$\tan \phi = \frac{V_c}{V_R}$

$= \frac{I X_c}{I R} = \frac{X_c}{R}$

$\tan \phi = \frac{1}{\omega C R}$

अंकों का योग



②

यो  
स्त

+

पृष्ठ 2 के अंक

=

कुल अंक



प्रश्न क्र.

Now,

$$\phi = \tan^{-1} \frac{1}{\frac{1}{\sin 60^\circ}}$$

phase difference

Question - 20

OR

Prove Gauss Theorem.

B  
S  
E

Gauss Theorem. →

The net electric flux through any closed surface is ~~the~~  $1/\epsilon_0$  time of the charge enclosed in it.

$$\phi = \frac{q}{\epsilon_0}$$

where,

$\phi$  = Electric flux.

$q$  = charge.

$\epsilon_0$  = dielectric constant

3

$$\square + \square = \square$$

योग पू. पृष्ठ      पृष्ठ 3 के अंक      अंक



प्रश्न क्र.

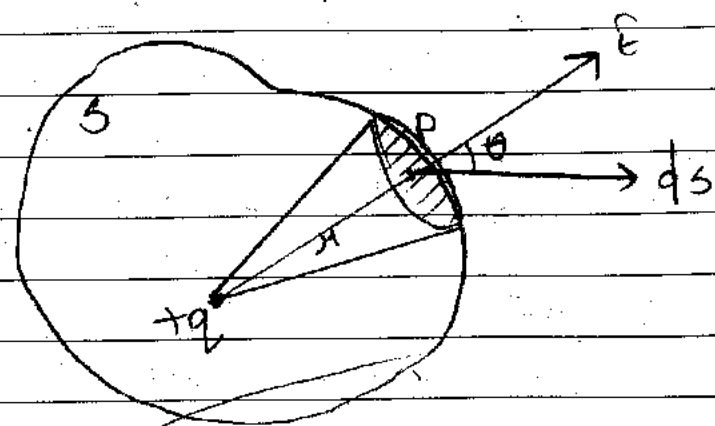

B  
S  
E

→ Suppose a closed surface S and charge +q enclosed within pt.

→ A point P is marked at distance r from the charge and surface area marked is dS.

→ Angle θ is there between the net electric field and component of area.

We know that,

$$\text{Electric flux} = \text{Electric field} \times \text{Area} \times \cos \theta.$$

$$\phi = E dS \cos \theta \rightarrow (1)$$

4

$$\boxed{\quad} + \boxed{\quad} = \boxed{\quad}$$

योग 4 व पृष्ठ                      पृष्ठ 4 के अंक



We know,

$$E = \frac{1}{4\pi\epsilon_0} \times \frac{q}{r^2}$$

Putting the value of eq<sup>n</sup> E in eq<sup>n</sup> (1)

we get

$$\begin{aligned} \phi &= \frac{1}{4\pi\epsilon_0} \times \frac{q}{r^2} \times ds \cos\theta \\ &= \frac{1}{4\pi\epsilon_0} \times q \times \frac{ds \cos\theta}{r^2} \end{aligned}$$

$\frac{ds \cos\theta}{r^2}$  is the solid angle =  $d\omega$

$$\phi = \frac{1}{4\pi\epsilon_0} \times q \times d\omega$$

Here the value of solid angle is  $4\pi$   
So,  $d\omega = 4\pi$

$$\phi = \frac{1}{4\pi\epsilon_0} \times q \times 4\pi$$

$$\boxed{\phi = \frac{q}{\epsilon_0}}$$

Gauss Theorem.

Hence, the Gauss Theorem is proved.