

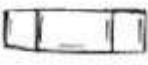













Exercise 10.1

1. For each of the given solid, the two views are given. Match for each solid the corresponding top and front views. The first one is done for you.

Object	Side view	Top view
(a)  A bottle	(i) 	(i) 
(b)  A weight	(ii) 	(ii) 
(c)  A flask	(iii) 	(iii) 
(d) 	(iv) 	(iv) 
(e)  Container	(v) 	(v) 

Solution:

- (a) (iii) (iv)
- (b) (i) (v)
- (c) (iv) (ii)
- (d) (v) (iii)
- (e) (ii) (i)

2. For each of the given solid, the three views are given. Identify for each solid the corresponding top, front and side views.

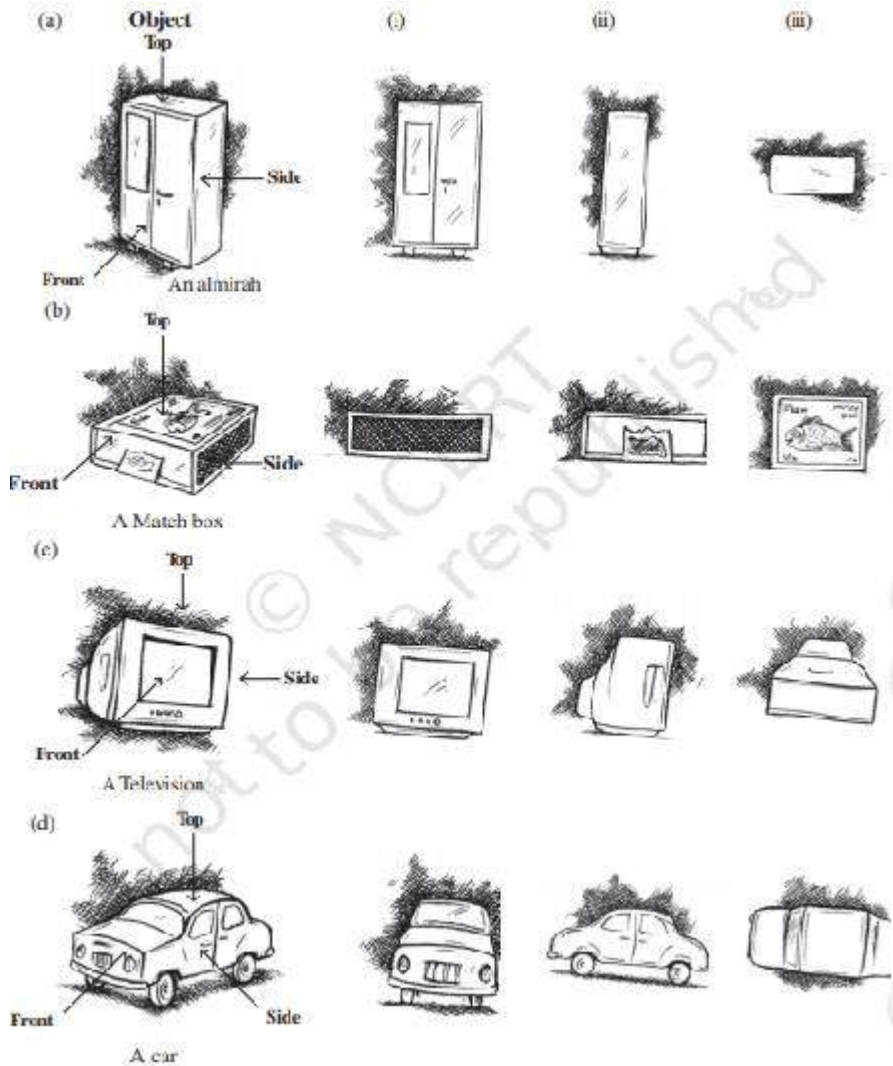

Solution:

- (a) (i) Front (ii) Side (iii) Top view
- (b) (i) Side (ii) Front (iii) Top view
- (c) (i) Front (ii) Side (iii) Top view
- (d) (i) Front (ii) Side (iii) Top view

3. For each given solid, identify the top view, front view and side view.

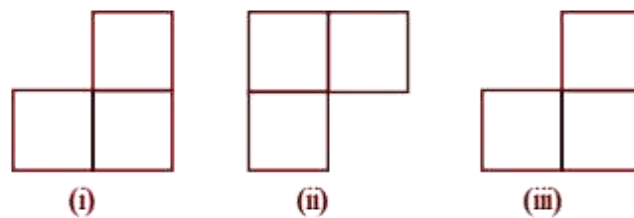
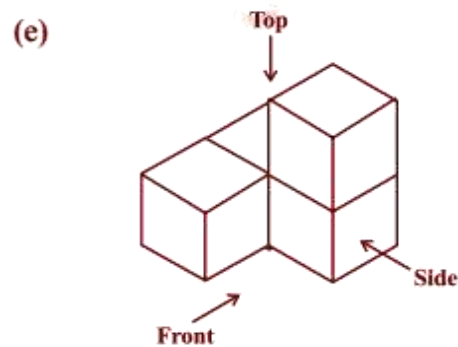
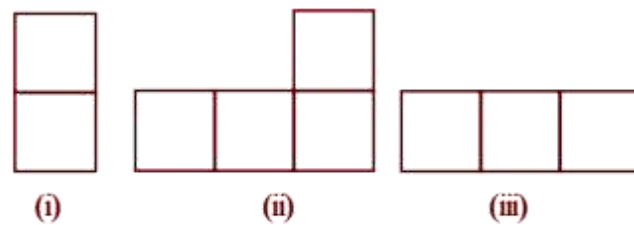
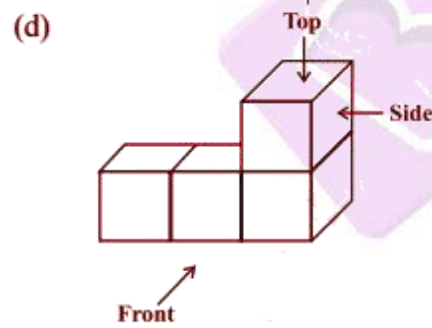
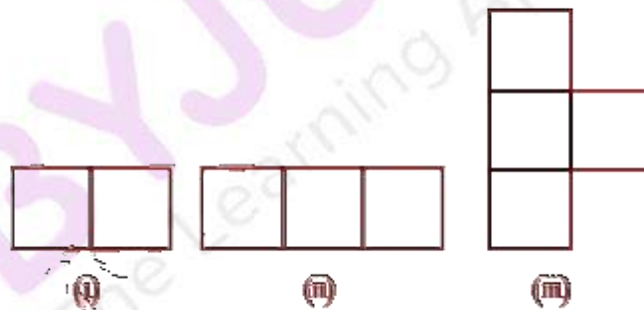
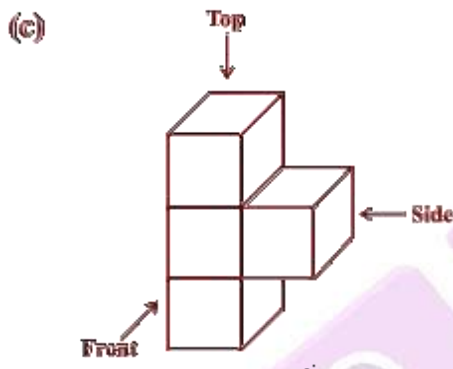
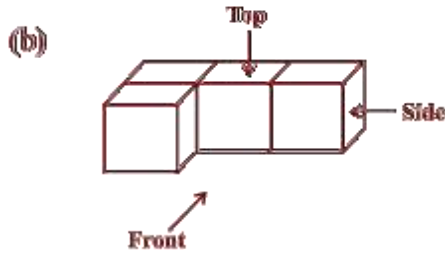
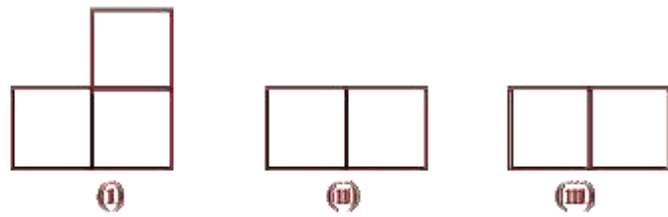
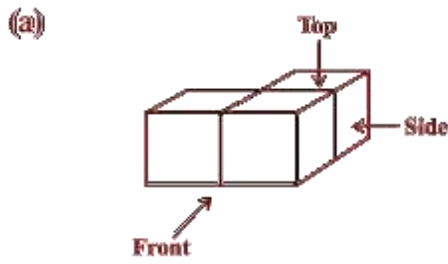

Solution:

- (a) (i) Top view (ii) Front view (iii) Side view
- (b) (i) Side view (ii) Front view (iii) Top view
- (c) (i) Top view (ii) Side view (iii) Front view
- (d) (i) Side view(ii) Front View(iii) Top view
- (e) (i) Front view(ii) Top view(iii) Side view

4. Draw the front view, side view and top view of the given objects:

(a) A military tent

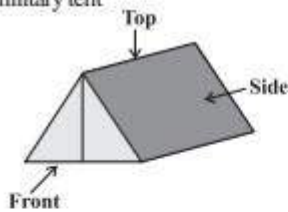

(b) A table

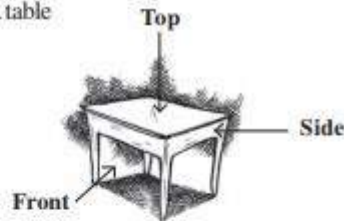

(c) A nut

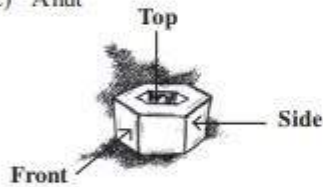

(d) A hexagonal block

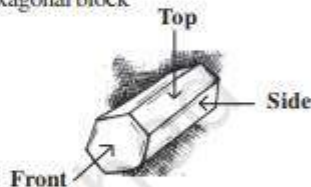



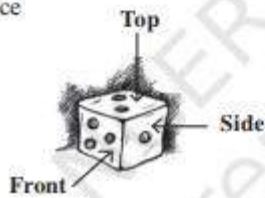

(e) A dice

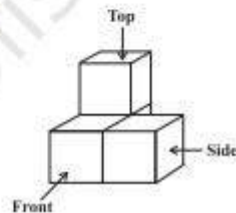



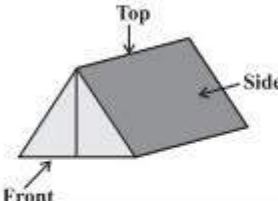
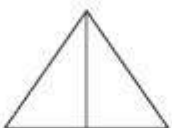

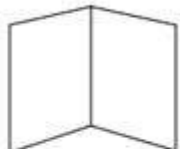
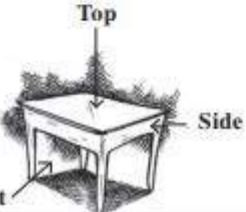
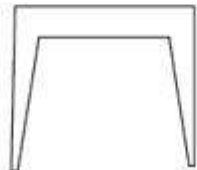

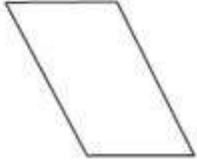

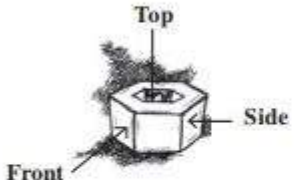

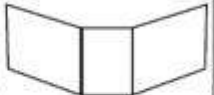

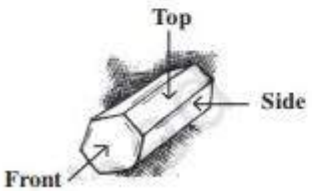
(f) A solid

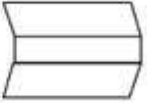

Solution:

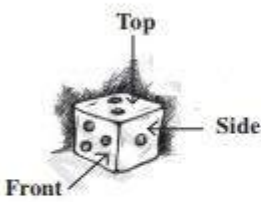
Sl No	Object	Front-view	Side view	Top view
(a)	<p>A military tent</p> 			
(b)	<p>A table</p> 			

Sl No	Object	Front-view	Side view	Top view
(c)	<p>A nut</p> 			
(d)	<p>A hexagonal block</p> 			

Sl No	Object	Front-view	Side view	Top view
(e)	<p>A dice</p> 			
(f)	<p>A solid</p> 