

Q. 1 – Q. 5 carry one mark each.

Q.1 “When she fell down the _____, she received many _____ but little help.”

The words that best fill the blanks in the above sentence are

- (A) stairs, stares (B) stairs, stairs
(C) stares, stairs (D) stares, stares

Q.2 “In spite of being warned repeatedly, he failed to correct his _____ behaviour.”

The word that best fills the blank in the above sentence is

- (A) rational (B) reasonable (C) errant (D) good

Q.3 For $0 \leq x \leq 2\pi$, $\sin x$ and $\cos x$ are both decreasing functions in the interval _____.

- (A) $(0, \frac{\pi}{2})$ (B) $(\frac{\pi}{2}, \pi)$ (C) $(\pi, \frac{3\pi}{2})$ (D) $(\frac{3\pi}{2}, 2\pi)$

Q.4 The area of an equilateral triangle is $\sqrt{3}$. What is the perimeter of the triangle?

- (A) 2 (B) 4 (C) 6 (D) 8

Q.5 Arrange the following three-dimensional objects in the descending order of their volumes:

- (i) A cuboid with dimensions 10 cm, 8 cm and 6 cm
(ii) A cube of side 8 cm
(iii) A cylinder with base radius 7 cm and height 7 cm
(iv) A sphere of radius 7 cm

- (A) (i), (ii), (iii), (iv)
(B) (ii), (i), (iv), (iii)
(C) (iii), (ii), (i), (iv)
(D) (iv), (iii), (ii), (i)

Q. 6 – Q. 10 carry two marks each.

Q.6 An automobile travels from city A to city B and returns to city A by the same route. The speed of the vehicle during the onward and return journeys were constant at 60 km/h and 90 km/h, respectively. What is the average speed in km/h for the entire journey?

- (A) 72 (B) 73 (C) 74 (D) 75

- Q.7 A set of 4 parallel lines intersect with another set of 5 parallel lines. How many parallelograms are formed?
- (A) 20 (B) 48 (C) 60 (D) 72
- Q.8 To pass a test, a candidate needs to answer at least 2 out of 3 questions correctly. A total of 6,30,000 candidates appeared for the test. Question A was correctly answered by 3,30,000 candidates. Question B was answered correctly by 2,50,000 candidates. Question C was answered correctly by 2,60,000 candidates. Both questions A and B were answered correctly by 1,00,000 candidates. Both questions B and C were answered correctly by 90,000 candidates. Both questions A and C were answered correctly by 80,000 candidates. If the number of students answering all questions correctly is the same as the number answering none, how many candidates failed to clear the test?
- (A) 30,000 (B) 2,70,000 (C) 3,90,000 (D) 4,20,000
- Q.9 If $x^2 + x - 1 = 0$ what is the value of $x^4 + \frac{1}{x^4}$?
- (A) 1 (B) 5 (C) 7 (D) 9
- Q.10 In a detailed study of annual crow births in India, it was found that there was relatively no growth during the period 2002 to 2004 and a sudden spike from 2004 to 2005. In another unrelated study, it was found that the revenue from cracker sales in India which remained fairly flat from 2002 to 2004, saw a sudden spike in 2005 before declining again in 2006. The solid line in the graph below refers to annual sale of crackers and the dashed line refers to the annual crow births in India. Choose the most appropriate inference from the above data.

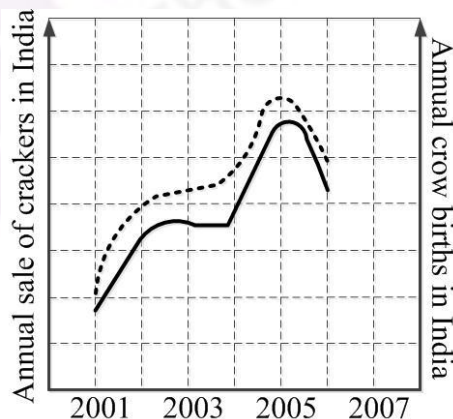

- (A) There is a strong correlation between crow birth and cracker sales.
 (B) Cracker usage increases crow birth rate.
 (C) If cracker sale declines, crow birth will decline.
 (D) Increased birth rate of crows will cause an increase in the sale of crackers.

END OF THE QUESTION PAPER

Q. 1 – Q. 25 carry one mark each.

Q.1 The eigenvalues of a Hermitian matrix are all

- (A) real
 (B) imaginary
 (C) of modulus one
 (D) real and positive

Q.2 Which one of the following represents the $3p$ radial wave function of hydrogen atom? (a_0 is the Bohr radius)

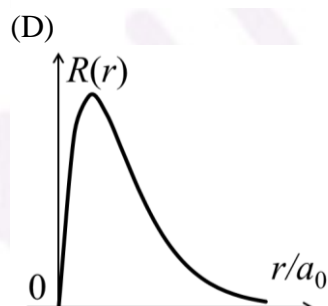
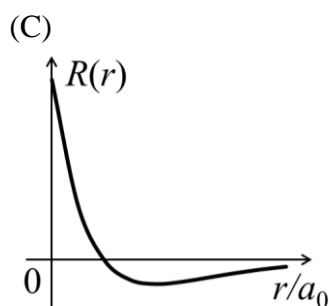
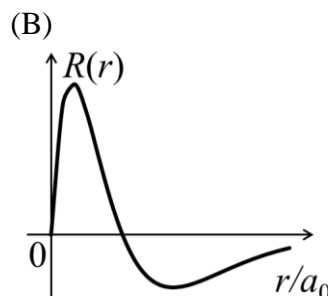
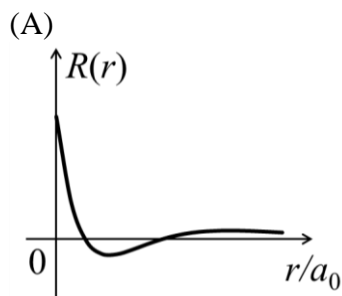

Q.3 Given the following table,

Group I	Group II
P: Stern-Gerlach experiment	1: Wave nature of particles
Q: Zeeman effect	2: Quantization of energy of electrons in the atoms
R: Frank-Hertz experiment	3: Existence of electron spin
S: Davisson-Germer experiment	4: Space quantization of angular momentum

which one of the following correctly matches the experiments from Group I to their inferences in Group II?

- (A) P-2, Q-3, R-4, S-1
 (B) P-1, Q-3, R-2, S-4
 (C) P-3, Q-4, R-2, S-1
 (D) P-2, Q-1, R-4, S-3

Q.4 In spherical polar coordinates (r, θ, ϕ) , the unit vector $\hat{\theta}$ at $(10, \pi/4, \pi/2)$ is

- (A) \hat{k} (B) $\frac{1}{\sqrt{2}}(\hat{j} + \hat{k})$ (C) $\frac{1}{\sqrt{2}}(-\hat{j} + \hat{k})$ (D) $\frac{1}{\sqrt{2}}(\hat{j} - \hat{k})$

- Q.5 The scale factors corresponding to the covariant metric tensor g_{ij} in spherical polar coordinates are
 (A) $1, r^2, r^2 \sin^2 \theta$ (B) $1, r^2, \sin^2 \theta$ (C) $1, 1, 1$ (D) $1, r, r \sin \theta$
- Q.6 In the context of small oscillations, which one of the following does NOT apply to the normal coordinates?
 (A) Each normal coordinate has an eigen-frequency associated with it
 (B) The normal coordinates are orthogonal to one another
 (C) The normal coordinates are all independent
 (D) The potential energy of the system is a sum of squares of the normal coordinates with constant coefficients
- Q.7 For the given unit cells of a two dimensional square lattice, which option lists all the primitive cells?

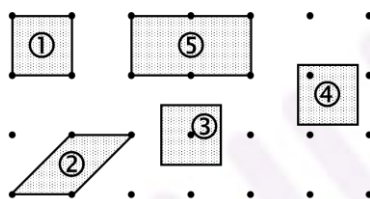

- (A) ① and ② (B) ①, ② and ③
 (C) ①, ②, ③ and ④ (D) ①, ②, ③, ④ and ⑤
- Q.8 Among electric field (\vec{E}), magnetic field (\vec{B}), angular momentum (\vec{L}), and vector potential (\vec{A}), which is/are **odd** under parity (space inversion) operation?
 (A) \vec{E} only (B) \vec{E} & \vec{A} only (C) \vec{E} & \vec{B} only (D) \vec{B} & \vec{L} only
- Q.9 The expression for the second overtone frequency in the vibrational absorption spectra of a diatomic molecule in terms of the harmonic frequency ω_e and anharmonicity constant x_e is
 (A) $2\omega_e(1 - x_e)$ (B) $2\omega_e(1 - 3x_e)$ (C) $3\omega_e(1 - 2x_e)$ (D) $3\omega_e(1 - 4x_e)$
- Q.10 Match the physical effects and order of magnitude of their energy scales given below, where $\alpha = \frac{e^2}{4\pi\epsilon_0\hbar c}$ is fine structure constant; m_e and m_p are electron and proton mass, respectively.

Group I	Group II
P: Lamb shift	1: $\sim \mathcal{O}(\alpha^2 m_e c^2)$
Q: Fine structure	2: $\sim \mathcal{O}(\alpha^4 m_e c^2)$
R: Bohr energy	3: $\sim \mathcal{O}(\alpha^4 m_e^2 c^2 / m_p)$
S: Hyperfine structure	4: $\sim \mathcal{O}(\alpha^5 m_e c^2)$

- (A) P-3, Q-1, R-2, S-4 (B) P-2, Q-3, R-1, S-4
 (C) P-4, Q-2, R-1, S-3 (D) P-2, Q-4, R-1, S-3

- Q.11 The logic expression $\bar{A}BC + \bar{A}\bar{B}C + AB\bar{C} + A\bar{B}\bar{C}$ can be simplified to
 (A) $A \text{ XOR } C$ (B) $A \text{ AND } \bar{C}$ (C) 0 (D) 1
- Q.12 At low temperatures (T), the specific heat of common metals is described by (with α and β as constants)
 (A) $\alpha T + \beta T^3$ (B) βT^3 (C) $\exp(-\alpha/T)$ (D) $\alpha T + \beta T^5$
- Q.13 In a 2-to-1 multiplexer as shown below, the output $X = A_0$ if $C = 0$, and $X = A_1$ if $C = 1$.

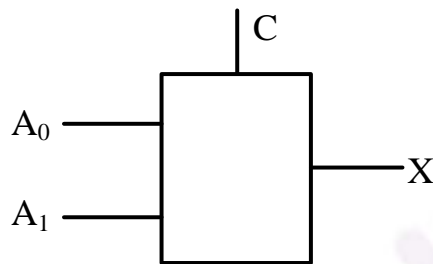

Which one of the following is the correct implementation of this multiplexer?

- (A) (B)
- (C) (D)

- Q.14 The elementary particle Ξ^0 is placed in the baryon decuplet, shown below, at

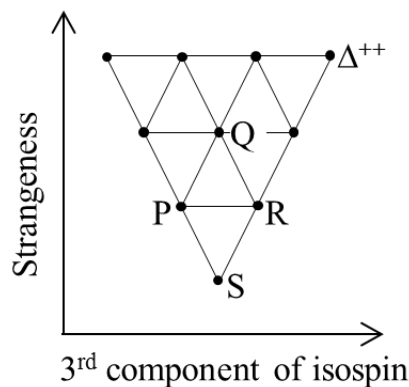

- (A) P (B) Q (C) R (D) S

- Q.15 The intrinsic/permanent electric dipole moment in the ground state of hydrogen atom is (a_0 is the Bohr radius)
- (A) $-3ea_0$ (B) zero (C) ea_0 (D) $3ea_0$
- Q.16 The high temperature magnetic susceptibility of solids having ions with magnetic moments can be described by $\chi \propto \frac{1}{T+\theta}$ with T as absolute temperature and θ as constant. The three behaviors i.e. paramagnetic, ferromagnetic and anti-ferromagnetic are described, respectively, by
- (A) $\theta < 0, \theta > 0, \theta = 0$ (B) $\theta > 0, \theta < 0, \theta = 0$
 (C) $\theta = 0, \theta < 0, \theta > 0$ (D) $\theta = 0, \theta > 0, \theta < 0$
- Q.17 Which one of the following is an allowed electric dipole transition?
- (A) $^1S_0 \rightarrow ^3S_1$ (B) $^2P_{3/2} \rightarrow ^2D_{5/2}$ (C) $^2D_{5/2} \rightarrow ^2P_{1/2}$ (D) $^3P_0 \rightarrow ^5D_0$
- Q.18 In the decay, $\mu^+ \rightarrow e^+ + \nu_e + X$, what is X ?
- (A) γ (B) $\bar{\nu}_e$ (C) ν_μ (D) $\bar{\nu}_\mu$
- Q.19 A spaceship is travelling with a velocity of $0.7c$ away from a space station. The spaceship ejects a probe with a velocity $0.59c$ opposite to its own velocity. A person in the space station would see the probe moving at a speed Xc , where the value of X is _____ (up to three decimal places).
- Q.20 For an operational amplifier (ideal) circuit shown below,

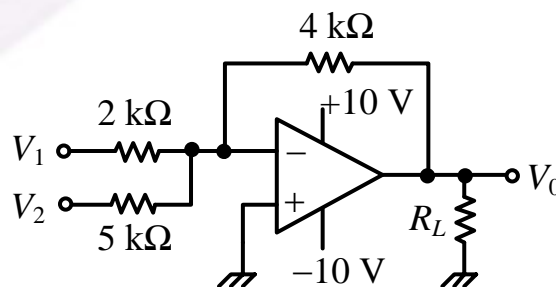

if $V_1 = 1$ V and $V_2 = 2$ V, the value of V_0 is _____ V (up to one decimal place).

- Q.21 An infinitely long straight wire is carrying a steady current I . The ratio of magnetic energy density at distance r_1 to that at $r_2 (= 2r_1)$ from the wire is _____.

- Q.22 A light beam of intensity I_0 is falling normally on a surface. The surface absorbs 20% of the intensity and the rest is reflected. The radiation pressure on the surface is given by $X I_0/c$, where X is _____ (up to one decimal place). Here c is the speed of light.
- Q.23 The number of independent components of a general electromagnetic field tensor is _____.
- Q.24 If X is the dimensionality of a free electron gas, the energy (E) dependence of density of states is given by $E^{\frac{1}{2}X-Y}$, where Y is _____.
- Q.25 For nucleus ^{164}Er , a $J^\pi = 2^+$ state is at 90 keV. Assuming ^{164}Er to be a rigid rotor, the energy of its 4^+ state is _____ keV (up to one decimal place).

Q. 26 – Q. 55 carry two marks each.

Q.26 Given $\vec{V}_1 = \hat{i} - \hat{j}$ and $\vec{V}_2 = -2\hat{i} + 3\hat{j} + 2\hat{k}$, which one of the following \vec{V}_3 makes $(\vec{V}_1, \vec{V}_2, \vec{V}_3)$ a complete set for a three dimensional real linear vector space ?

(A) $\vec{V}_3 = \hat{i} + \hat{j} + 4\hat{k}$

(B) $\vec{V}_3 = 2\hat{i} - \hat{j} + 2\hat{k}$

(C) $\vec{V}_3 = \hat{i} + 2\hat{j} + 6\hat{k}$

(D) $\vec{V}_3 = 2\hat{i} + \hat{j} + 4\hat{k}$

Q.27 An interstellar object has speed v at the point of its shortest distance R from a star of much larger mass M . Given $v^2 = 2GM/R$, the trajectory of the object is

(A) circle

(B) ellipse

(C) parabola

(D) hyperbola

Q.28 A particle moves in one dimension under a potential $V(x) = \alpha|x|$ with some non-zero total energy. Which one of the following best describes the particle trajectory in the phase space?

(A)

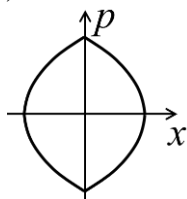

(B)

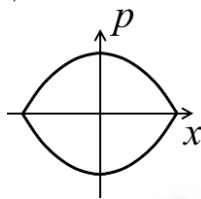

(C)

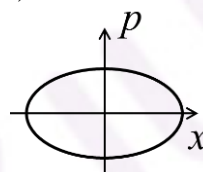

(D)

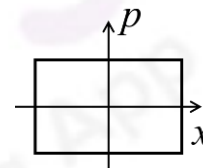

Q.29 Consider an infinitely long solenoid with N turns per unit length, radius R and carrying a current $I(t) = \alpha \cos \omega t$, where α is a constant and ω is the angular frequency. The magnitude of electric field at the surface of the solenoid is

(A) $\frac{1}{2}\mu_0 NR\omega\alpha \sin \omega t$

(B) $\frac{1}{2}\mu_0 \omega NR \cos \omega t$

(C) $\mu_0 NR\omega\alpha \sin \omega t$

(D) $\mu_0 \omega NR \cos \omega t$

Q.30 A constant and uniform magnetic field $\vec{B} = B_0\hat{k}$ pervades all space. Which one of the following is the correct choice for the vector potential in Coulomb gauge?

(A) $-B_0(x+y)\hat{i}$

(B) $B_0(x+y)\hat{j}$

(C) $B_0x\hat{j}$

(D) $-\frac{1}{2}B_0(x\hat{i} - y\hat{j})$

Q.31 If H is the Hamiltonian for a free particle with mass m , the commutator $[x, [x, H]]$ is

(A) \hbar^2/m

(B) $-\hbar^2/m$

(C) $-\hbar^2/(2m)$

(D) $\hbar^2/(2m)$

- Q.32 A long straight wire, having radius a and resistance per unit length r , carries a current I . The magnitude and direction of the Poynting vector on the surface of the wire is
- (A) $I^2 r / 2\pi a$, perpendicular to axis of the wire and pointing inwards
(B) $I^2 r / 2\pi a$, perpendicular to axis of the wire and pointing outwards
(C) $I^2 r / \pi a$, perpendicular to axis of the wire and pointing inwards
(D) $I^2 r / \pi a$, perpendicular to axis of the wire and pointing outwards
- Q.33 Three particles are to be distributed in four non-degenerate energy levels. The possible number of ways of distribution: (i) for distinguishable particles, and (ii) for identical Bosons, respectively, is
- (A) (i) 24, (ii) 4 (B) (i) 24, (ii) 20 (C) (i) 64, (ii) 20 (D) (i) 64, (ii) 16
- Q.34 The term symbol for the electronic ground state of oxygen atom is
- (A) 1S_0 (B) 1D_2 (C) 3P_0 (D) 3P_2
- Q.35 The energy dispersion for electrons in one dimensional lattice with lattice parameter a is given by $E(k) = E_0 - \frac{1}{2}W \cos ka$, where W and E_0 are constants. The effective mass of the electron near the bottom of the band is
- (A) $\frac{2\hbar^2}{Wa^2}$ (B) $\frac{\hbar^2}{Wa^2}$ (C) $\frac{\hbar^2}{2Wa^2}$ (D) $\frac{\hbar^2}{4Wa^2}$
- Q.36 Amongst electrical resistivity (ρ), thermal conductivity (κ), specific heat (C), Young's modulus (Y), and magnetic susceptibility (χ), which quantities show a sharp change at the superconducting transition temperature?
- (A) ρ, κ, C, Y (B) ρ, C, χ (C) ρ, κ, C, χ (D) κ, Y, χ

- Q.37 A quarter wave plate introduces a path difference of $\lambda/4$ between the two components of polarization parallel and perpendicular to the optic axis. An electromagnetic wave with $\vec{E} = (\hat{x} + \hat{y}) E_0 e^{i(kz - \omega t)}$ is incident normally on a quarter wave plate which has its optic axis making an angle 135° with the x -axis as shown.

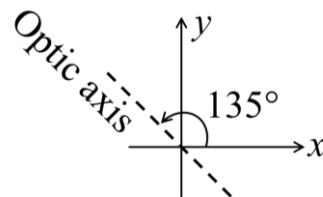

The emergent electromagnetic wave would be

- (A) elliptically polarized
 (B) circularly polarized
 (C) linearly polarized with polarization as that of incident wave
 (D) linearly polarized but with polarization at 90° to that of the incident wave
- Q.38 A p -doped semiconductor slab carries a current $I = 100$ mA in a magnetic field $B = 0.2$ T as shown. One measures $V_y = 0.25$ mV and $V_x = 2$ mV. The mobility of holes in the semiconductor is _____ $\text{m}^2\text{V}^{-1}\text{s}^{-1}$ (up to two decimal places).

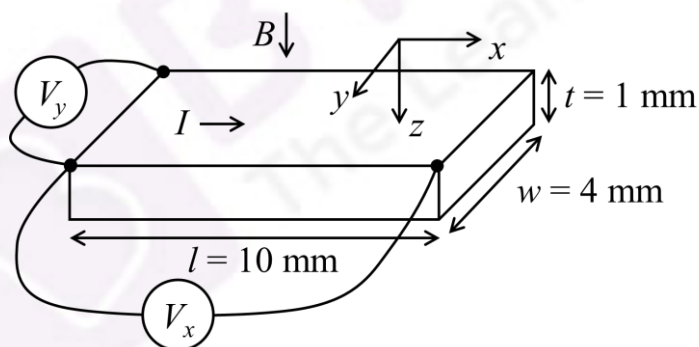

- Q.39 An n-channel FET having Gate-Source switch-off voltage $V_{GS(OFF)} = -2 \text{ V}$ is used to invert a $0 - 5 \text{ V}$ square-wave signal as shown. The maximum allowed value of R would be _____ $\text{k}\Omega$ (up to two decimal places).

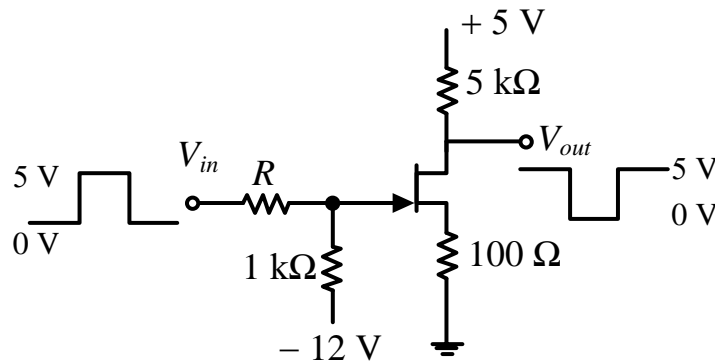

- Q.40 Inside a large nucleus, a nucleon with mass $939 \text{ MeV}c^{-2}$ has Fermi momentum 1.40 fm^{-1} at absolute zero temperature. Its velocity is Xc , where the value of X is _____ (up to two decimal places).

$$(\hbar c = 197 \text{ MeV}\cdot\text{fm})$$

- Q.41 4 MeV γ -rays emitted by the de-excitation of ^{19}F are attributed, assuming spherical symmetry, to the transition of protons from $1d_{3/2}$ state to $1d_{5/2}$ state. If the contribution of spin-orbit term to the total energy is written as $C(\vec{l} \cdot \vec{s})$, the magnitude of C is _____ MeV (up to one decimal place).

- Q.42 An α particle is emitted by a $^{230}_{90}\text{Th}$ nucleus. Assuming the potential to be purely Coulombic beyond the point of separation, the height of the Coulomb barrier is _____ MeV (up to two decimal places).

$$\left(\frac{e^2}{4\pi\epsilon_0} = 1.44 \text{ MeV}\cdot\text{fm}, r_0 = 1.30 \text{ fm}\right)$$

- Q.43 For the transformation

$$Q = \sqrt{2q} e^{-1+2\alpha} \cos p, \quad P = \sqrt{2q} e^{-\alpha-1} \sin p$$

(where α is a constant) to be canonical, the value of α is _____.

Q.44 Given

$$\frac{d^2f(x)}{dx^2} - 2\frac{df(x)}{dx} + f(x) = 0,$$

and boundary conditions $f(0) = 1$ and $f(1) = 0$, the value of $f(0.5)$ is _____ (up to two decimal places).

Q.45 The absolute value of the integral

$$\int \frac{5z^3 + 3z^2}{z^2 - 4} dz,$$

over the circle $|z - 1.5| = 1$ in complex plane, is _____ (up to two decimal places).

Q.46 A uniform circular disc of mass m and radius R is rotating with angular speed ω about an axis passing through its center and making an angle $\theta = 30^\circ$ with the axis of the disc. If the kinetic energy of the disc is $\alpha m \omega^2 R^2$, the value of α is _____ (up to 2 decimal places).



Q.47 The ground state energy of a particle of mass m in an infinite potential well is E_0 . It changes to $E_0(1 + \alpha \times 10^{-3})$, when there is a small potential bump of height $V_0 = \frac{\pi^2 \hbar^2}{50mL^2}$ and width $a = L/100$, as shown in the figure. The value of α is _____ (up to two decimal places).

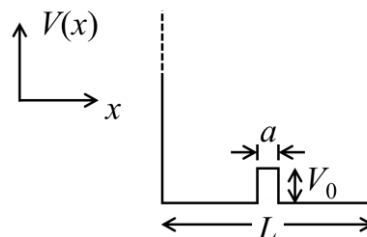

- Q.48 An electromagnetic plane wave is propagating with an intensity $I = 1.0 \times 10^5 \text{ Wm}^{-2}$ in a medium with $\epsilon = 3\epsilon_0$ and $\mu = \mu_0$. The amplitude of the electric field inside the medium is _____ $\times 10^3 \text{ Vm}^{-1}$ (up to one decimal place).

$$(\epsilon_0 = 8.85 \times 10^{-12} \text{ C}^2 \text{ N}^{-1} \text{ m}^{-2}, \mu_0 = 4\pi \times 10^{-7} \text{ NA}^{-2}, c = 3 \times 10^8 \text{ ms}^{-1})$$

- Q.49 A microcanonical ensemble consists of 12 atoms with each taking either energy 0 state, or energy ϵ state. Both states are non-degenerate. If the total energy of this ensemble is 4ϵ , its entropy will be _____ k_B (up to one decimal place), where k_B is the Boltzmann constant.

- Q.50 A two-state quantum system has energy eigenvalues $\pm\epsilon$ corresponding to the normalized states $|\psi_{\pm}\rangle$. At time $t = 0$, the system is in quantum state $\frac{1}{\sqrt{2}}[|\psi_+\rangle + |\psi_-\rangle]$. The probability that the system will be in the same state at $t = h/(6\epsilon)$ is _____ (up to two decimal places).

- Q.51 An air-conditioner maintains the room temperature at 27°C while the outside temperature is 47°C . The heat conducted through the walls of the room from outside to inside due to temperature difference is 7000 W . The minimum work done by the compressor of the air-conditioner per unit time is _____ W .

- Q.52 Two solid spheres A and B have same emissivity. The radius of A is four times the radius of B, and temperature of A is twice the temperature of B. The ratio of the rate of heat radiated from A to that from B is _____.

- Q.53 The partition function of an ensemble at a temperature T is

$$Z = \left(2 \cosh \frac{\epsilon}{k_B T} \right)^N,$$

where k_B is the Boltzmann constant. The heat capacity of this ensemble at $T = \frac{\epsilon}{k_B}$ is $X N k_B$, where the value of X is _____ (up to two decimal places).

- Q.54 An atom in its singlet state is subjected to a magnetic field. The Zeeman splitting of its 650 nm spectral line is 0.03 nm . The magnitude of the field is _____ Tesla (up to two decimal places).

$$(e = 1.60 \times 10^{-19} \text{ C}, m_e = 9.11 \times 10^{-31} \text{ kg}, c = 3.0 \times 10^8 \text{ ms}^{-1})$$

Q.55 The quantum effects in an ideal gas become important below a certain temperature T_Q when de Broglie wavelength corresponding to the *root mean square* thermal speed becomes equal to the inter-atomic separation. For such a gas of atoms of mass 2×10^{-26} kg and number density $6.4 \times 10^{25} \text{ m}^{-3}$, $T_Q = \underline{\hspace{2cm}} \times 10^{-3} \text{ K}$ (up to one decimal place).

$$(k_B = 1.38 \times 10^{-23} \text{ J/K}, h = 6.6 \times 10^{-34} \text{ J-s})$$

END OF THE QUESTION PAPER

