

Exercise 6.1

Page: 122

1. Fill in the blanks using correct word given in the brackets:-

(i) All circles are _____. (congruent, similar)

Answer: Similar

(ii) All squares are _____. (similar, congruent)

Answer: Similar

(iii) All _____ triangles are similar. (isosceles, equilateral)

Answer: Equilateral

(iv) Two polygons of the same number of sides are similar, if (a) their corresponding angles are _____ and (b) their corresponding sides are _____. (equal, proportional)

Answer: (a) Equal

(b) Proportional

2. Give two different examples of pair of

(i) Similar figures

(ii) Non-similar figures

Solution:

(i) Example of two similar figure;

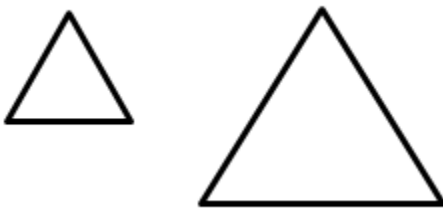

Two Equilateral Triangle



Two Rectangle

(ii) Example of two Non-similar figure;

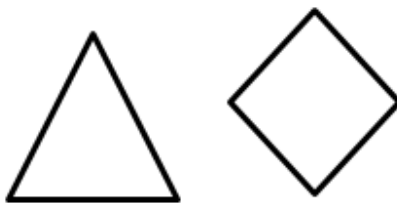

Triangle

Rhombus

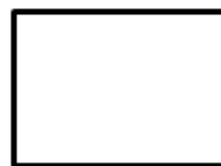

Rectangle



Trapezium

3. State whether the following quadrilaterals are similar or not:

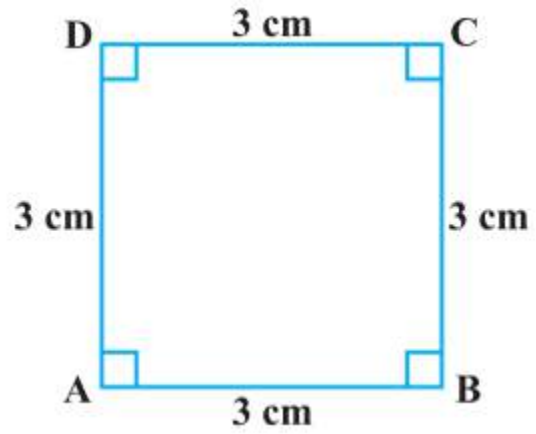
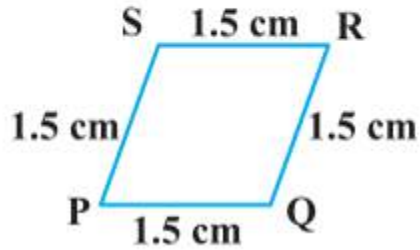

Solution:

From the given two figures, we can see their corresponding angles are different or unequal. Therefore they are not similar.

Exercise 6.2

Page: 128

1. In figure. (i) and (ii), $DE \parallel BC$. Find EC in (i) and AD in (ii).

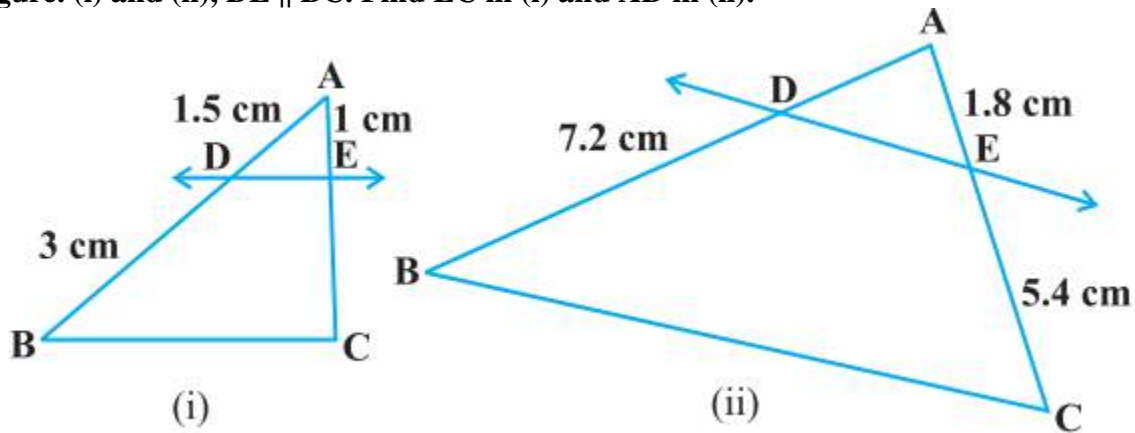

Solution:

(i) Given, in $\triangle ABC$, $DE \parallel BC$

$\therefore AD/DB = AE/EC$ [Using Basic proportionality theorem]

$$\Rightarrow 1.5/3 = 1/EC$$

$$\Rightarrow EC = 3/1.5$$

$$EC = 3 \times 10/15 = 2 \text{ cm}$$

Hence, $EC = 2 \text{ cm}$.

(ii) Given, in $\triangle ABC$, $DE \parallel BC$

$\therefore AD/DB = AE/EC$ [Using Basic proportionality theorem]

$$\Rightarrow AD/7.2 = 1.8 / 5.4$$

$$\Rightarrow AD = 1.8 \times 7.2/5.4 = (18/10) \times (72/10) \times (10/54) = 24/10$$

$$\Rightarrow AD = 2.4$$

Hence, $AD = 2.4 \text{ cm}$.

2. E and F are points on the sides PQ and PR respectively of a $\triangle PQR$. For each of the following cases, state whether $EF \parallel QR$.

(i) $PE = 3.9 \text{ cm}$, $EQ = 3 \text{ cm}$, $PF = 3.6 \text{ cm}$ and $FR = 2.4 \text{ cm}$

(ii) $PE = 4 \text{ cm}$, $QE = 4.5 \text{ cm}$, $PF = 8 \text{ cm}$ and $RF = 9 \text{ cm}$

(iii) $PQ = 1.28 \text{ cm}$, $PR = 2.56 \text{ cm}$, $PE = 0.18 \text{ cm}$ and $PF = 0.63 \text{ cm}$

Solution:

Given, in $\triangle PQR$, E and F are two points on side PQ and PR respectively. See the figure below;

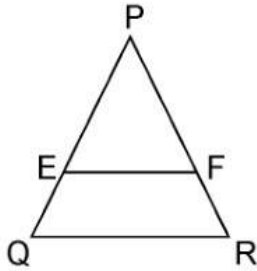

(i) Given, $PE = 3.9$ cm, $EQ = 3$ cm, $PF = 3.6$ cm and $FR = 2.4$ cm

Therefore, by using Basic proportionality theorem, we get,

$$PE/EQ = 3.9/3 = 39/30 = 13/10 = 1.3$$

$$\text{And } PF/FR = 3.6/2.4 = 36/24 = 3/2 = 1.5$$

So, we get, $PE/EQ \neq PF/FR$

Hence, EF is not parallel to QR .

(ii) Given, $PE = 4$ cm, $QE = 4.5$ cm, $PF = 8$ cm and $RF = 9$ cm

Therefore, by using Basic proportionality theorem, we get,

$$PE/QE = 4/4.5 = 40/45 = 8/9$$

$$\text{And, } PF/RF = 8/9$$

So, we get here,

$$PE/QE = PF/RF$$

Hence, EF is parallel to QR .

(iii) Given, $PQ = 1.28$ cm, $PR = 2.56$ cm, $PE = 0.18$ cm and $PF = 0.36$ cm

From the figure,

$$EQ = PQ - PE = 1.28 - 0.18 = 1.10 \text{ cm}$$

$$\text{And, } FR = PR - PF = 2.56 - 0.36 = 2.20 \text{ cm}$$

$$\text{So, } PE/EQ = 0.18/1.10 = 18/110 = 9/55 \dots\dots\dots \text{(i)}$$

$$\text{And, } PF/FR = 0.36/2.20 = 36/220 = 9/55 \dots\dots\dots \text{(ii)}$$

So, we get here,

$$PE/EQ = PF/FR$$

Hence, EF is parallel to QR .

3. In the figure, if $LM \parallel CB$ and $LN \parallel CD$, prove that $AM/AB = AN/AD$

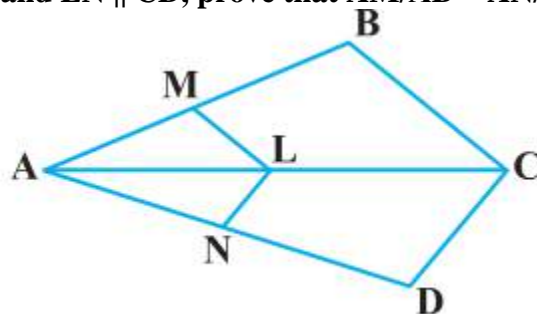

Solution:

In the given figure, we can see, $LM \parallel CB$,

By using basic proportionality theorem, we get,
 $AM/AB = AL/AC$(i)

Similarly, given, $LN \parallel CD$ and using basic proportionality theorem,
 $\therefore AN/AD = AL/AC$(ii)

From equation (i) and (ii), we get,
 $AM/AB = AN/AD$
 Hence, proved.

4. In the figure, $DE \parallel AC$ and $DF \parallel AE$. Prove that $BF/FE = BE/EC$

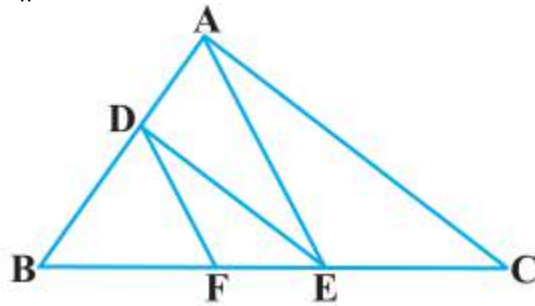

Solution:

In $\triangle ABC$, given as, $DE \parallel AC$
 Thus, by using Basic Proportionality Theorem, we get,

$$\therefore BD/DA = BE/EC \text{(i)}$$

In $\triangle ABC$, given as, $DF \parallel AE$
 Thus, by using Basic Proportionality Theorem, we get,

$$\therefore BD/DA = BF/FE \text{(ii)}$$

From equation (i) and (ii), we get
 $BE/EC = BF/FE$
 Hence, proved.

5. In the figure, $DE \parallel OQ$ and $DF \parallel OR$, show that $EF \parallel QR$.

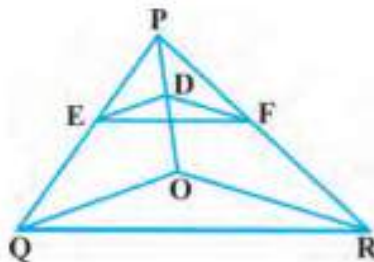

Solution:

Given,

In ΔPQO , $DE \parallel OQ$

So by using Basic Proportionality Theorem,

$$PD/DO = PE/EQ \dots\dots\dots \text{..(i)}$$

Again given, in ΔPOR , $DF \parallel OR$,

So by using Basic Proportionality Theorem,

$$PD/DO = PF/FR \dots\dots\dots \text{(ii)}$$

From equation (i) and (ii), we get,

$$PE/EQ = PF/FR$$

Therefore, by converse of Basic Proportionality Theorem,

$EF \parallel QR$, in ΔPQR .

6. In the figure, A, B and C are points on OP, OQ and OR respectively such that $AB \parallel PQ$ and $AC \parallel PR$. Show that $BC \parallel QR$.

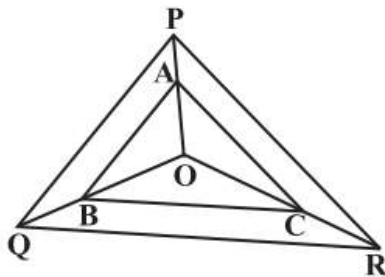

Solution:

Given here,

In ΔOPQ , $AB \parallel PQ$

By using Basic Proportionality Theorem,

$$OA/AP = OB/BQ \dots\dots\dots \text{(i)}$$

Also given,

In ΔOPR , $AC \parallel PR$

By using Basic Proportionality Theorem

$$\therefore OA/AP = OC/CR \dots\dots\dots \text{(ii)}$$

From equation (i) and (ii), we get,

$$OB/BQ = OC/CR$$

Therefore, by converse of Basic Proportionality Theorem,
In ΔOQR , $BC \parallel QR$.

7. Using Basic proportionality theorem, prove that a line drawn through the mid-points of one side of a triangle parallel to another side bisects the third side. (Recall that you have proved it in Class IX).

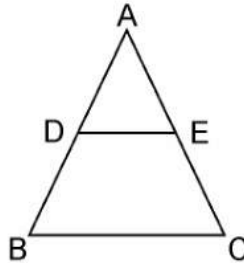

Solution:

Given, in ΔABC , D is the midpoint of AB such that $AD = DB$.
A line parallel to BC intersects AC at E as shown in above figure such that $DE \parallel BC$.

We have to prove that E is the mid point of AC.

Since, D is the mid-point of AB.
 $\therefore AD = DB$
 $\Rightarrow AD/DB = 1 \dots\dots\dots (i)$

In ΔABC , $DE \parallel BC$,
 By using Basic Proportionality Theorem,
 Therefore, $AD/DB = AE/EC$
 From equation (i), we can write,
 $\Rightarrow 1 = AE/EC$
 $\therefore AE = EC$
 Hence, proved, E is the midpoint of AC.

8. Using Converse of basic proportionality theorem, prove that the line joining the mid-points of any two sides of a triangle is parallel to the third side. (Recall that you have done it in Class IX).

Solution:

Given, in ΔABC , D and E are the mid points of AB and AC respectively, such that,
 $AD = BD$ and $AE = EC$.

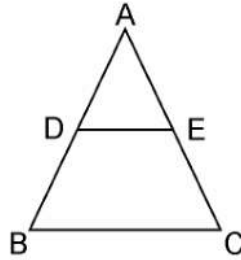

We have to prove that: $DE \parallel BC$.

Since, D is the midpoint of AB

$$\therefore AD = DB$$

$$\Rightarrow AD/BD = 1 \dots\dots\dots \text{(i)}$$

Also given, E is the mid-point of AC.

$$\therefore AE = EC$$

$$\Rightarrow AE/EC = 1$$

From equation (i) and (ii), we get,

$$AD/BD = AE/EC$$

By converse of Basic Proportionality Theorem,

$$DE \parallel BC$$

Hence, proved.

9. ABCD is a trapezium in which $AB \parallel DC$ and its diagonals intersect each other at the point O. Show that $AO/BO = CO/DO$.

Solution:

Given, ABCD is a trapezium where $AB \parallel DC$ and diagonals AC and BD intersect each other at O.

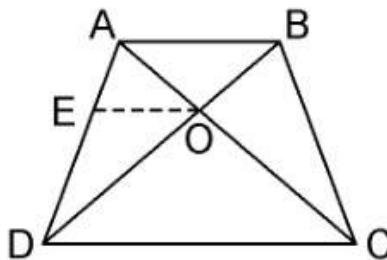

We have to prove, $AO/BO = CO/DO$

From the point O, draw a line EO touching AD at E, in such a way that,
 $EO \parallel DC \parallel AB$

In $\triangle ADC$, we have $OE \parallel DC$
 Therefore, By using Basic Proportionality Theorem
 $AE/ED = AO/CO$ (i)

Now, In $\triangle ABD$, $OE \parallel AB$
 Therefore, By using Basic Proportionality Theorem

$$DE/EA = DO/BO$$
.....(ii)

From equation (i) and (ii), we get,
 $AO/CO = BO/DO$
 $\Rightarrow AO/BO = CO/DO$
 Hence, proved.

10. The diagonals of a quadrilateral ABCD intersect each other at the point O such that $AO/BO = CO/DO$. Show that ABCD is a trapezium.

Solution:

Given, Quadrilateral ABCD where AC and BD intersect each other at O such that,
 $AO/BO = CO/DO$.

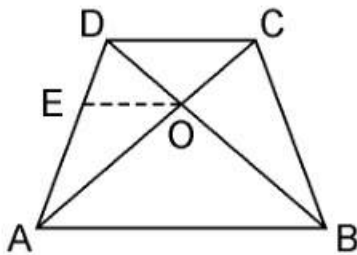

We have to prove here, ABCD is a trapezium

From the point O, draw a line EO touching AD at E, in such a way that,
 $EO \parallel DC \parallel AB$

In $\triangle DAB$, $EO \parallel AB$
 Therefore, By using Basic Proportionality Theorem
 $DE/EA = DO/OB$ (i)

Also, given,
 $AO/BO = CO/DO$
 $\Rightarrow AO/CO = BO/DO$
 $\Rightarrow CO/AO = DO/BO$

$$\Rightarrow DO/OB = CO/AO \dots\dots\dots(ii)$$

From equation (i) and (ii), we get

$$DE/EA = CO/AO$$

Therefore, By using converse of Basic Proportionality Theorem,

$EO \parallel DC$ also $EO \parallel AB$

$\Rightarrow AB \parallel DC$.

Hence, quadrilateral ABCD is a trapezium with $AB \parallel CD$.

Exercise 6.3

1. State which pairs of triangles in Figure, are similar. Write the similarity criterion used by you for answering the question and also write the pairs of similar triangles in the symbolic form:

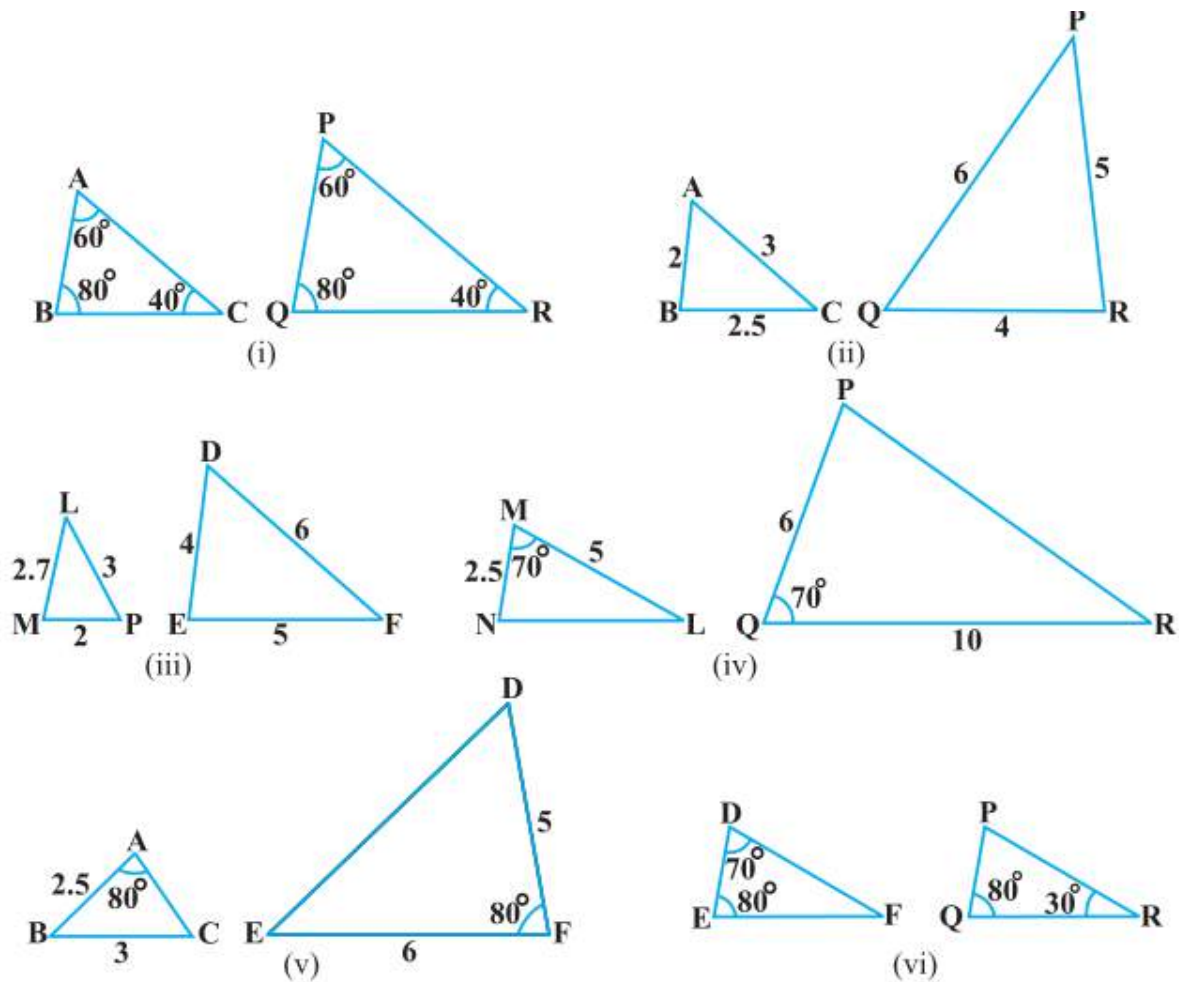

Solution:

(i) Given, in $\triangle ABC$ and $\triangle PQR$,

$\angle A = \angle P = 60^\circ$

$\angle B = \angle Q = 80^\circ$

$\angle C = \angle R = 40^\circ$

Therefore by AAA similarity criterion,

$\therefore \triangle ABC \sim \triangle PQR$

(ii) Given, in $\triangle ABC$ and $\triangle PQR$,
 $AB/QR = BC/RP = CA/PQ$

By SSS similarity criterion,
 $\triangle ABC \sim \triangle QRP$

(iii) Given, in $\triangle LMP$ and $\triangle DEF$,

$LM = 2.7$, $MP = 2$, $LP = 3$, $EF = 5$, $DE = 4$, $DF = 6$

$$MP/DE = 2/4 = 1/2$$

$$PL/DF = 3/6 = 1/2$$

$$LM/EF = 2.7/5 = 27/50$$

Here, $MP/DE = PL/DF \neq LM/EF$

Therefore, $\triangle LMP$ and $\triangle DEF$ are not similar.

(iv) In $\triangle MNL$ and $\triangle QPR$, it is given,

$$MN/QP = ML/QR = 1/2$$

$$\angle M = \angle Q = 70^\circ$$

Therefore, by SAS similarity criterion

$$\therefore \triangle MNL \sim \triangle QPR$$

(v) In $\triangle ABC$ and $\triangle DEF$, given that,

$$AB = 2.5$$
, $BC = 3$, $\angle A = 80^\circ$, $EF = 6$, $DF = 5$, $\angle F = 80^\circ$

$$\text{Here, } AB/DF = 2.5/5 = 1/2$$

$$\text{And, } BC/EF = 3/6 = 1/2$$

$$\Rightarrow \angle B \neq \angle F$$

Hence, $\triangle ABC$ and $\triangle DEF$ are not similar.

(vi) In $\triangle DEF$, by sum of angles of triangles, we know that,

$$\angle D + \angle E + \angle F = 180^\circ$$

$$\Rightarrow 70^\circ + 80^\circ + \angle F = 180^\circ$$

$$\Rightarrow \angle F = 180^\circ - 70^\circ - 80^\circ$$

$$\Rightarrow \angle F = 30^\circ$$

Similarly, In $\triangle PQR$,

$$\angle P + \angle Q + \angle R = 180 \text{ (Sum of angles of } \triangle)$$

$$\Rightarrow \angle P + 80^\circ + 30^\circ = 180^\circ$$

$$\Rightarrow \angle P = 180^\circ - 80^\circ - 30^\circ$$

$$\Rightarrow \angle P = 70^\circ$$

Now, comparing both the triangles, $\triangle DEF$ and $\triangle PQR$, we have

$$\angle D = \angle P = 70^\circ$$

$$\angle F = \angle Q = 80^\circ$$

$$\angle F = \angle R = 30^\circ$$

Therefore, by AAA similarity criterion,

Hence, $\triangle DEF \sim \triangle PQR$

2. In the figure, $\triangle ODC \propto \frac{1}{4} \triangle OBA$, $\angle BOC = 125^\circ$ and $\angle CDO = 70^\circ$. Find $\angle DOC$, $\angle DCO$ and $\angle OAB$.

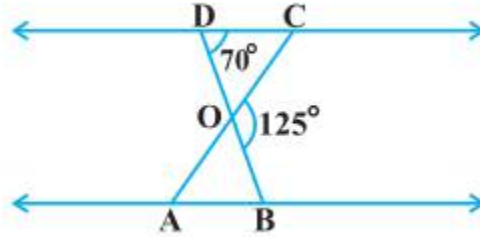

Solution:

As we can see from the figure, DOB is a straight line.

Therefore, $\angle DOC + \angle COB = 180^\circ$

$$\begin{aligned} \Rightarrow \angle DOC &= 180^\circ - 125^\circ \text{ (Given, } \angle BOC = 125^\circ) \\ &= 55^\circ \end{aligned}$$

In $\triangle ODC$, sum of the measures of the angles of a triangle is 180°

Therefore, $\angle DCO + \angle CDO + \angle DOC = 180^\circ$

$$\Rightarrow \angle DCO + 70^\circ + 55^\circ = 180^\circ \text{ (Given, } \angle CDO = 70^\circ)$$

$$\Rightarrow \angle DCO = 55^\circ$$

It is given that, $\triangle ODC \propto \frac{1}{4} \triangle OBA$,

Therefore, $\triangle ODC \sim \triangle OBA$.

Hence, Corresponding angles are equal in similar triangles

$$\angle OAB = \angle OCD$$

$$\Rightarrow \angle OAB = 55^\circ$$

$$\angle OAB = \angle OCD$$

$$\Rightarrow \angle OAB = 55^\circ$$

3. Diagonals AC and BD of a trapezium ABCD with $AB \parallel DC$ intersect each other at the point O. Using a similarity criterion for two triangles, show that $AO/OC = OB/OD$

Solution:

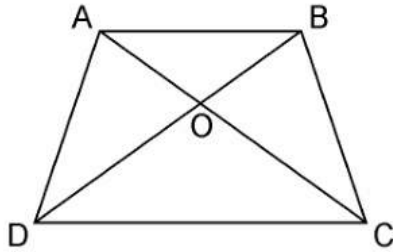

In $\triangle DOC$ and $\triangle BOA$,
 $AB \parallel CD$, thus alternate interior angles will be equal,
 $\therefore \angle CDO = \angle ABO$

Similarly,
 $\angle DCO = \angle BAO$

Also, for the two triangles $\triangle DOC$ and $\triangle BOA$, vertically opposite angles will be equal;
 $\therefore \angle DOC = \angle BOA$

Hence, by AAA similarity criterion,
 $\triangle DOC \sim \triangle BOA$

Thus, the corresponding sides are proportional.

$$\frac{DO}{BO} = \frac{OC}{OA}$$

$$\Rightarrow \frac{OA}{OC} = \frac{OB}{OD}$$

Hence, proved.

4. In the fig.6.36, $\frac{QR}{QS} = \frac{QT}{PR}$ and $\angle 1 = \angle 2$. Show that $\triangle PQS \sim \triangle TQR$.

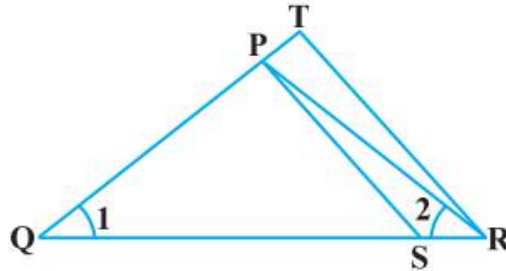

Solution:

In $\triangle PQR$,
 $\angle PQR = \angle PRQ$
 $\therefore PQ = PR$ (i)

Given,
 $\frac{QR}{QS} = \frac{QT}{PR}$
 Using equation (i), we get
 $\frac{QR}{QS} = \frac{QT}{QP}$(ii)

In $\triangle PQS$ and $\triangle TQR$, by equation (ii),

$$QR/QS = QT/QP$$

$$\angle Q = \angle Q$$

$\therefore \Delta PQS \sim \Delta TQR$ [By SAS similarity criterion]

5. S and T are point on sides PR and QR of ΔPQR such that $\angle P = \angle RTS$. Show that $\Delta RPQ \sim \Delta RTS$.

Solution:

Given, S and T are point on sides PR and QR of ΔPQR

And $\angle P = \angle RTS$.

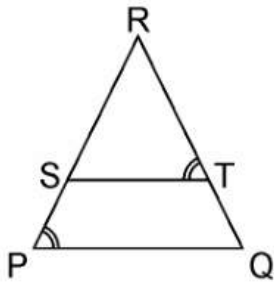

In ΔRPQ and ΔRTS ,

$$\angle RTS = \angle QPS \text{ (Given)}$$

$$\angle R = \angle R \text{ (Common angle)}$$

$\therefore \Delta RPQ \sim \Delta RTS$ (AA similarity criterion)

6. In the figure, if $\Delta ABE \cong \Delta ACD$, show that $\Delta ADE \sim \Delta ABC$.

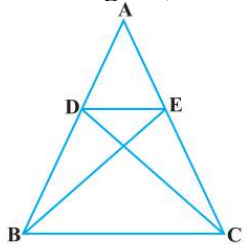

Solution:

Given, $\Delta ABE \cong \Delta ACD$.

$$\therefore AB = AC \text{ [By CPCT]} \dots\dots\dots\text{(i)}$$

$$\text{And, } AD = AE \text{ [By CPCT]} \dots\dots\dots\text{(ii)}$$

In ΔADE and ΔABC , dividing eq.(ii) by eq(i),

$$AD/AB = AE/AC$$

$$\angle A = \angle A \text{ [Common angle]}$$

$\therefore \Delta ADE \sim \Delta ABC$ [SAS similarity criterion]

7. In the figure, altitudes AD and CE of $\triangle ABC$ intersect each other at the point P. Show that:

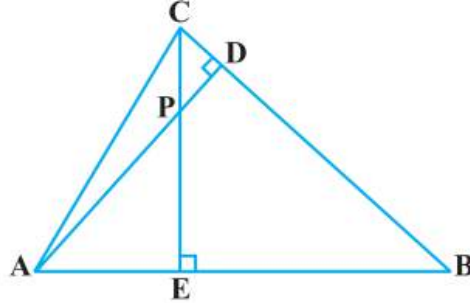

- (i) $\triangle AEP \sim \triangle CDP$
- (ii) $\triangle ABD \sim \triangle CBE$
- (iii) $\triangle AEP \sim \triangle ADB$
- (iv) $\triangle PDC \sim \triangle BEC$

Solution:

Given, altitudes AD and CE of $\triangle ABC$ intersect each other at the point P.

(i) In $\triangle AEP$ and $\triangle CDP$,
 $\angle AEP = \angle CDP$ (90° each)
 $\angle APE = \angle CPD$ (Vertically opposite angles)
 Hence, by AA similarity criterion,
 $\triangle AEP \sim \triangle CDP$

(ii) In $\triangle ABD$ and $\triangle CBE$,
 $\angle ADB = \angle CEB$ (90° each)
 $\angle ABD = \angle CBE$ (Common Angles)
 Hence, by AA similarity criterion,
 $\triangle ABD \sim \triangle CBE$

(iii) In $\triangle AEP$ and $\triangle ADB$,
 $\angle AEP = \angle ADB$ (90° each)
 $\angle PAE = \angle DAB$ (Common Angles)
 Hence, by AA similarity criterion,
 $\triangle AEP \sim \triangle ADB$

(iv) In $\triangle PDC$ and $\triangle BEC$,
 $\angle PDC = \angle BEC$ (90° each)
 $\angle PCD = \angle BCE$ (Common angles)
 Hence, by AA similarity criterion,
 $\triangle PDC \sim \triangle BEC$

8. E is a point on the side AD produced of a parallelogram ABCD and BE intersects CD at F. Show that $\triangle ABE \sim \triangle CFB$.

Solution:

Given, E is a point on the side AD produced of a parallelogram ABCD and BE intersects CD at F. Consider the figure below,

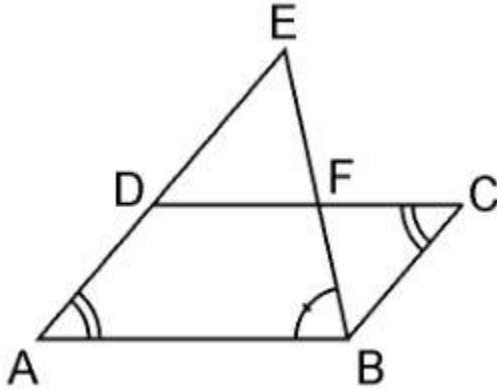

In $\triangle ABE$ and $\triangle CFB$,
 $\angle A = \angle C$ (Opposite angles of a parallelogram)
 $\angle AEB = \angle CBF$ (Alternate interior angles as $AE \parallel BC$)
 $\therefore \triangle ABE \sim \triangle CFB$ (AA similarity criterion)

9. In the figure, ABC and AMP are two right triangles, right angled at B and M respectively, prove that:

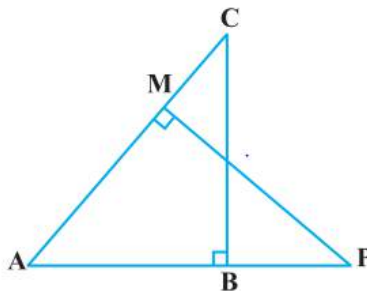

- (i) $\triangle ABC \sim \triangle AMP$
- (ii) $CA/PA = BC/MP$

Solution:

Given, ABC and AMP are two right triangles, right angled at B and M respectively.

(i) In $\triangle ABC$ and $\triangle AMP$, we have,
 $\angle CAB = \angle MAP$ (common angles)
 $\angle ABC = \angle AMP = 90^\circ$ (each 90°)
 $\therefore \triangle ABC \sim \triangle AMP$ (AA similarity criterion)

(ii) As, $\triangle ABC \sim \triangle AMP$ (AA similarity criterion)

If two triangles are similar then the corresponding sides are always equal,
Hence, $CA/PA = BC/MP$

10. CD and GH are respectively the bisectors of $\angle ACB$ and $\angle EGF$ such that D and H lie on sides AB and FE of $\triangle ABC$ and $\triangle EFG$ respectively. If $\triangle ABC \sim \triangle EFG$, Show that:

(i) $CD/GH = AC/FG$

(ii) $\triangle DCB \sim \triangle HGE$

(iii) $\triangle DCA \sim \triangle HGF$

Solution:

Given, CD and GH are respectively the bisectors of $\angle ACB$ and $\angle EGF$ such that D and H lie on sides AB and FE of $\triangle ABC$ and $\triangle EFG$ respectively.

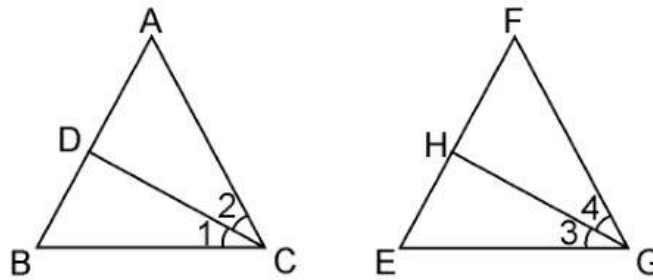

(i) From the given condition,

$\triangle ABC \sim \triangle EFG$.

$\therefore \angle A = \angle F$, $\angle B = \angle E$, and $\angle ACB = \angle FGE$

Since, $\angle ACB = \angle FGE$

$\therefore \angle ACD = \angle FGH$ (Angle bisector)

And, $\angle DCB = \angle HGE$ (Angle bisector)

In $\triangle ACD$ and $\triangle FGH$,

$\angle A = \angle F$

$\angle ACD = \angle FGH$

$\therefore \triangle ACD \sim \triangle FGH$ (AA similarity criterion)

$\Rightarrow CD/GH = AC/FG$

(ii) In $\triangle DCB$ and $\triangle HGE$,

$\angle DCB = \angle HGE$ (Already proved)

$\angle B = \angle E$ (Already proved)

$\therefore \triangle DCB \sim \triangle HGE$ (AA similarity criterion)

(iii) In $\triangle DCA$ and $\triangle HGF$,

$\angle ACD = \angle FGH$ (Already proved)

$\angle A = \angle F$ (Already proved)

$\therefore \triangle DCA \sim \triangle HGF$ (AA similarity criterion)

11. In the following figure, E is a point on side CB produced of an isosceles triangle ABC with $AB = AC$. If $AD \perp BC$ and $EF \perp AC$, prove that $\triangle ABD \sim \triangle ECF$.

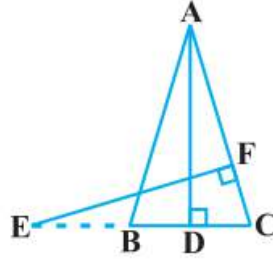

Solution:

Given, ABC is an isosceles triangle.

$$\therefore AB = AC$$

$$\Rightarrow \angle ABD = \angle ECF$$

In $\triangle ABD$ and $\triangle ECF$,

$$\angle ADB = \angle EFC \text{ (Each } 90^\circ\text{)}$$

$$\angle BAD = \angle CEF \text{ (Already proved)}$$

$$\therefore \triangle ABD \sim \triangle ECF \text{ (using AA similarity criterion)}$$

12. Sides AB and BC and median AD of a triangle ABC are respectively proportional to sides PQ and QR and median PM of $\triangle PQR$ (see Fig 6.41). Show that $\triangle ABC \sim \triangle PQR$.

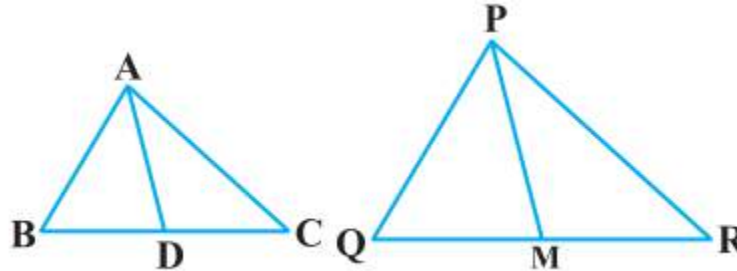

Solution:

Given, $\triangle ABC$ and $\triangle PQR$, AB, BC and median AD of $\triangle ABC$ are proportional to sides PQ, QR and median PM of $\triangle PQR$

$$\text{i.e. } AB/PQ = BC/QR = AD/PM$$

We have to prove: $\triangle ABC \sim \triangle PQR$

As we know here,

$$AB/PQ = BC/QR = AD/PM$$

$$\frac{AB}{PQ} = \frac{\frac{1}{2}BC}{\frac{1}{2}QR} = \frac{AD}{PM} \text{(i)}$$

$$\Rightarrow AB/PQ = BC/QR = AD/PM \text{ (D is the midpoint of BC. M is the midpoint of QR)}$$

$$\Rightarrow \triangle ABD \sim \triangle PQM \text{ [SSS similarity criterion]}$$

$\therefore \angle ABD = \angle PQM$ [Corresponding angles of two similar triangles are equal]
 $\Rightarrow \angle ABC = \angle PQR$

In $\triangle ABC$ and $\triangle PQR$

$AB/PQ = BC/QR$ (i)

$\angle ABC = \angle PQR$ (ii)

From equation (i) and (ii), we get,

$\triangle ABC \sim \triangle PQR$ [SAS similarity criterion]

13. D is a point on the side BC of a triangle ABC such that $\angle ADC = \angle BAC$. Show that $CA^2 = CB \cdot CD$

Solution:

Given, D is a point on the side BC of a triangle ABC such that $\angle ADC = \angle BAC$.

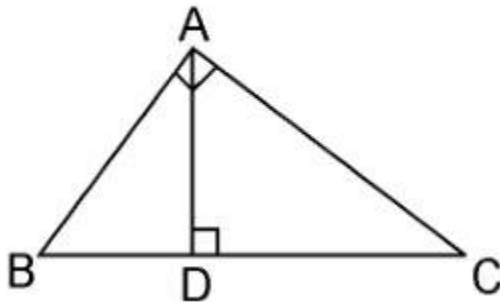

In $\triangle ADC$ and $\triangle BAC$,

$\angle ADC = \angle BAC$ (Already given)

$\angle ACD = \angle BCA$ (Common angles)

$\therefore \triangle ADC \sim \triangle BAC$ (AA similarity criterion)

We know that corresponding sides of similar triangles are in proportion.

$\therefore CA/CB = CD/CA$

$\Rightarrow CA^2 = CB \cdot CD$.

Hence, proved.

14. Sides AB and AC and median AD of a triangle ABC are respectively proportional to sides PQ and PR and median PM of another triangle PQR. Show that $\triangle ABC \sim \triangle PQR$.

Solution:

Given: Two triangles $\triangle ABC$ and $\triangle PQR$ in which AD and PM are medians such that;

$AB/PQ = AC/PR = AD/PM$

We have to prove, $\triangle ABC \sim \triangle PQR$

Let us construct first: Produce AD to E so that AD = DE. Join CE, Similarly produce PM to N such that PM = MN, also Join RN.

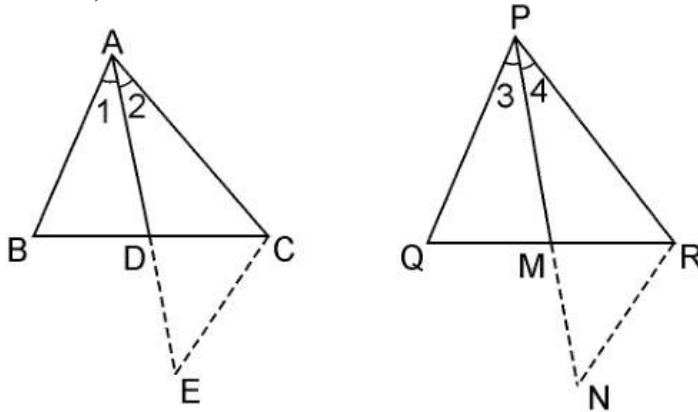

In $\triangle ABD$ and $\triangle CDE$, we have
 $AD = DE$ [By Construction.]
 $BD = DC$ [Since, AP is the median]
 and, $\angle ADB = \angle CDE$ [Vertically opposite angles]
 $\therefore \triangle ABD \cong \triangle CDE$ [SAS criterion of congruence]
 $\Rightarrow AB = CE$ [By CPCT](i)

Also, in $\triangle PQM$ and $\triangle MNR$,
 $PM = MN$ [By Construction.]
 $QM = MR$ [Since, PM is the median]
 and, $\angle PMQ = \angle NMR$ [Vertically opposite angles]
 $\therefore \triangle PQM \cong \triangle MNR$ [SAS criterion of congruence]
 $\Rightarrow PQ = RN$ [CPCT](ii)

Now, $AB/PQ = AC/PR = AD/PM$
 From equation (i) and (ii),
 $\Rightarrow CE/RN = AC/PR = AD/PM$
 $\Rightarrow CE/RN = AC/PR = 2AD/2PM$
 $\Rightarrow CE/RN = AC/PR = AE/PN$ [Since $2AD = AE$ and $2PM = PN$]
 $\therefore \triangle ACE \sim \triangle PRN$ [SSS similarity criterion]
 Therefore, $\angle 2 = \angle 4$
 Similarly, $\angle 1 = \angle 3$
 $\therefore \angle 1 + \angle 2 = \angle 3 + \angle 4$
 $\Rightarrow \angle A = \angle P$ (iii)

Now, in $\triangle ABC$ and $\triangle PQR$, we have
 $AB/PQ = AC/PR$ (Already given)
 From equation (iii),
 $\angle A = \angle P$
 $\therefore \triangle ABC \sim \triangle PQR$ [SAS similarity criterion]

15. A vertical pole of a length 6 m casts a shadow 4m long on the ground and at the same time a tower casts a shadow 28 m long. Find the height of the tower.

Solution:

Given, Length of the vertical pole = 6m

Shadow of the pole = 4 m

Let Height of tower = h m

Length of shadow of the tower = 28 m

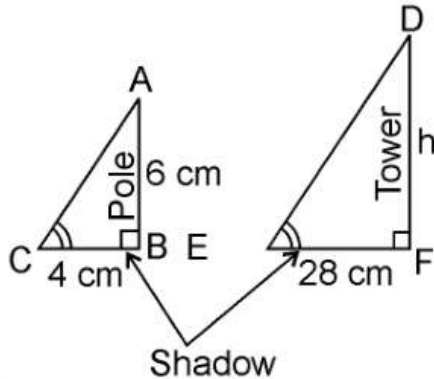

In $\triangle ABC$ and $\triangle DEF$,

$\angle C = \angle E$ (angular elevation of sun)

$\angle B = \angle F = 90^\circ$

$\therefore \triangle ABC \sim \triangle DEF$ (AA similarity criterion)

$\therefore AB/DF = BC/EF$ (If two triangles are similar corresponding sides are proportional)

$\therefore 6/h = 4/28$

$\Rightarrow h = (6 \times 28)/4$

$\Rightarrow h = 6 \times 7$

$\Rightarrow h = 42$ m

Hence, the height of the tower is 42 m.

16. If AD and PM are medians of triangles ABC and PQR, respectively where $\triangle ABC \sim \triangle PQR$ prove that $AB/PQ = AD/PM$.

Solution:

Given, $\triangle ABC \sim \triangle PQR$

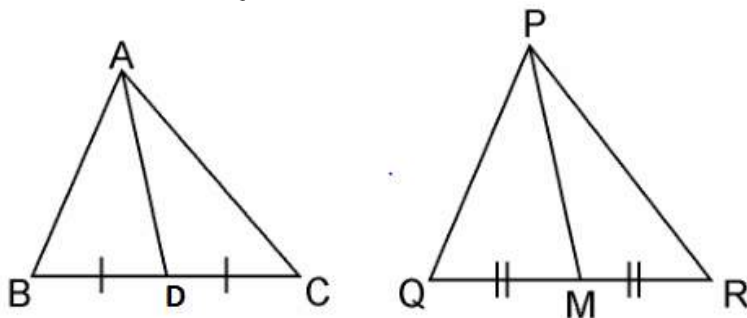

We know that the corresponding sides of similar triangles are in proportion.

$$\therefore AB/PQ = AC/PR = BC/QR \dots\dots\dots(\mathbf{i})$$

$$\text{Also, } \angle A = \angle P, \angle B = \angle Q, \angle C = \angle R \dots\dots\dots(\mathbf{ii})$$

Since AD and PM are medians, they will divide their opposite sides.

$$\therefore BD = BC/2 \text{ and } QM = QR/2 \dots\dots\dots(\mathbf{iii})$$

From equations (i) and (iii), we get

$$AB/PQ = BD/QM \dots\dots\dots(\mathbf{iv})$$

In $\triangle ABD$ and $\triangle PQM$,

From equation (ii), we have

$$\angle B = \angle Q$$

From equation (iv), we have,

$$AB/PQ = BD/QM$$

$$\therefore \triangle ABD \sim \triangle PQM \text{ (SAS similarity criterion)}$$

$$\Rightarrow AB/PQ = BD/QM = AD/PM$$

Exercise 6.4

Page: 143

1. Let $\triangle ABC \sim \triangle DEF$ and their areas be, respectively, 64 cm^2 and 121 cm^2 . If $EF = 15.4 \text{ cm}$, find BC .

Solution: Given, $\triangle ABC \sim \triangle DEF$,
 Area of $\triangle ABC = 64 \text{ cm}^2$
 Area of $\triangle DEF = 121 \text{ cm}^2$
 $EF = 15.4 \text{ cm}$

$$\therefore \frac{\text{Area of } \triangle ABC}{\text{Area of } \triangle DEF} = \frac{AB^2}{DE^2}$$

As we know, if two triangles are similar, ratio of their areas are equal to the square of the ratio of their corresponding sides,
 $= AC^2/DF^2 = BC^2/EF^2$

$$\begin{aligned} \therefore 64/121 &= BC^2/EF^2 \\ \Rightarrow (8/11)^2 &= (BC/15.4)^2 \\ \Rightarrow 8/11 &= BC/15.4 \\ \Rightarrow BC &= 8 \times 15.4/11 \\ \Rightarrow BC &= 8 \times 1.4 \\ \Rightarrow BC &= 11.2 \text{ cm} \end{aligned}$$

2. Diagonals of a trapezium $ABCD$ with $AB \parallel DC$ intersect each other at the point O . If $AB = 2CD$, find the ratio of the areas of triangles AOB and COD .

Solution:

Given, $ABCD$ is a trapezium with $AB \parallel DC$. Diagonals AC and BD intersect each other at point O .

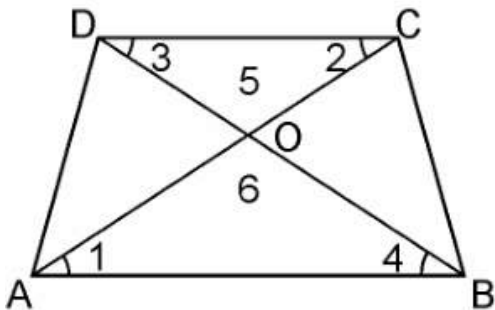

In $\triangle AOB$ and $\triangle COD$, we have
 $\angle 1 = \angle 2$ (Alternate angles)
 $\angle 3 = \angle 4$ (Alternate angles)
 $\angle 5 = \angle 6$ (Vertically opposite angle)
 $\therefore \triangle AOB \sim \triangle COD$ [AAA similarity criterion]

As we know, If two triangles are similar then the ratio of their areas are equal to the square of the ratio of their corresponding sides. Therefore,

$$\text{Area of } (\Delta AOB) / \text{Area of } (\Delta COD) = AB^2 / CD^2$$

$$= (2CD)^2 / CD^2 \quad [\because AB = 2CD]$$

$$\therefore \text{Area of } (\Delta AOB) / \text{Area of } (\Delta COD)$$

$$= 4CD^2 / CD^2 = 4/1$$

Hence, the required ratio of the area of ΔAOB and $\Delta COD = 4:1$

3. In the figure, ABC and DBC are two triangles on the same base BC. If AD intersects BC at O, show that area $(\Delta ABC) / \text{area } (\Delta DBC) = AO / DO$.

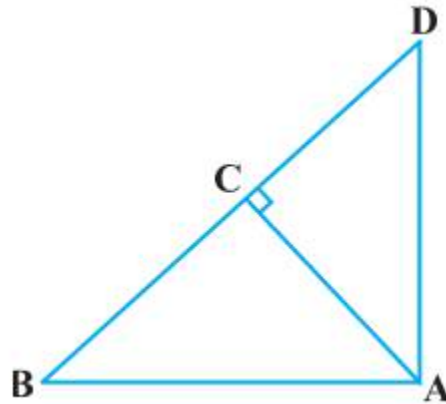

Solution:

Given, ABC and DBC are two triangles on the same base BC. AD intersects BC at O.

We have to prove: $\text{Area } (\Delta ABC) / \text{Area } (\Delta DBC) = AO / DO$

Let us draw two perpendiculars AP and DM on line BC.

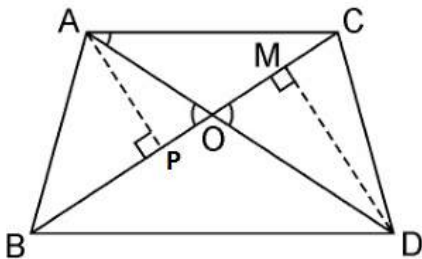

We know that area of a triangle = $1/2 \times \text{Base} \times \text{Height}$

$$\therefore \frac{\text{ar}(\Delta ABC)}{\text{ar}(\Delta DBC)} = \frac{\frac{1}{2} BC \times AP}{\frac{1}{2} BC \times DM} = \frac{AP}{DM}$$

In ΔAPO and ΔDMO ,

$\angle APO = \angle DMO$ (Each 90°)

$\angle AOP = \angle DOM$ (Vertically opposite angles)

$\therefore \Delta APO \sim \Delta DMO$ (AA similarity criterion)

$$\therefore AP/DM = AO/DO$$

$$\Rightarrow \text{Area}(\triangle ABC)/\text{Area}(\triangle DBC) = AO/DO.$$

4. If the areas of two similar triangles are equal, prove that they are congruent.

Solution:

Say $\triangle ABC$ and $\triangle PQR$ are two similar triangles and equal in area

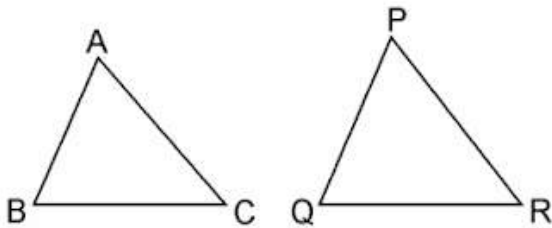

Now let us prove $\triangle ABC \cong \triangle PQR$.

Since, $\triangle ABC \sim \triangle PQR$

$$\therefore \text{Area of } (\triangle ABC)/\text{Area of } (\triangle PQR) = BC^2/QR^2$$

$$\Rightarrow BC^2/QR^2 = 1 \text{ [Since, Area}(\triangle ABC) = (\triangle PQR)]$$

$$\Rightarrow BC^2/QR^2 = 1$$

$$\Rightarrow BC = QR$$

Similarly, we can prove that

$$AB = PQ \text{ and } AC = PR$$

Thus, $\triangle ABC \cong \triangle PQR$ [SSS criterion of congruence]

5. D, E and F are respectively the mid-points of sides AB, BC and CA of $\triangle ABC$. Find the ratio of the area of $\triangle DEF$ and $\triangle ABC$.

Solution:

Given, D, E and F are respectively the mid-points of sides AB, BC and CA of $\triangle ABC$.

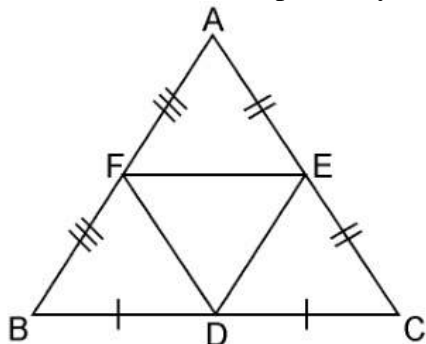

In $\triangle ABC$,

F is the mid-point of AB (Already given)

E is the mid-point of AC (Already given)

So, by the mid-point theorem, we have,
 $FE \parallel BC$ and $FE = \frac{1}{2}BC$
 $\Rightarrow FE \parallel BC$ and $FE \parallel BD$ [$BD = \frac{1}{2}BC$]
 Since, opposite sides of parallelogram are equal and parallel
 \therefore BDEF is parallelogram.

Similarly, in $\triangle FBD$ and $\triangle DEF$, we have
 $FB = DE$ (Opposite sides of parallelogram BDEF)
 $FD = FD$ (Common sides)
 $BD = FE$ (Opposite sides of parallelogram BDEF)
 $\therefore \triangle FBD \cong \triangle DEF$

Similarly, we can prove that
 $\triangle AFE \cong \triangle DEF$
 $\triangle EDC \cong \triangle DEF$

As we know, if triangles are congruent, then they are equal in area.
 So,

$$\text{Area}(\triangle FBD) = \text{Area}(\triangle DEF) \dots\dots\dots\text{(i)}$$

$$\text{Area}(\triangle AFE) = \text{Area}(\triangle DEF) \dots\dots\dots\text{(ii)}$$

and,

$$\text{Area}(\triangle EDC) = \text{Area}(\triangle DEF) \dots\dots\dots\text{(iii)}$$

Now,

$$\text{Area}(\triangle ABC) = \text{Area}(\triangle FBD) + \text{Area}(\triangle DEF) + \text{Area}(\triangle AFE) + \text{Area}(\triangle EDC) \dots\dots\dots\text{(iv)}$$

$$\text{Area}(\triangle ABC) = \text{Area}(\triangle DEF) + \text{Area}(\triangle DEF) + \text{Area}(\triangle DEF) + \text{Area}(\triangle DEF)$$

From equation (i), (ii) and (iii),
 $\Rightarrow \text{Area}(\triangle DEF) = \frac{1}{4}\text{Area}(\triangle ABC)$
 $\Rightarrow \text{Area}(\triangle DEF)/\text{Area}(\triangle ABC) = 1/4$

Hence, $\text{Area}(\triangle DEF) : \text{Area}(\triangle ABC) = 1:4$

6. Prove that the ratio of the areas of two similar triangles is equal to the square of the ratio of their corresponding medians.

Solution:

Given: AM and DN are the medians of triangles ABC and DEF respectively and $\triangle ABC \sim \triangle DEF$.

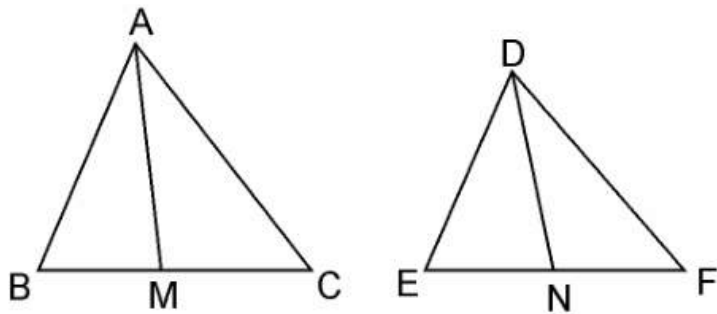

We have to prove: $\text{Area}(\triangle ABC)/\text{Area}(\triangle DEF) = AM^2/DN^2$

Since, $\triangle ABC \sim \triangle DEF$ (Given)

$$\therefore \text{Area}(\triangle ABC)/\text{Area}(\triangle DEF) = (AB^2/DE^2) \dots\dots\dots(\text{i})$$

$$\text{and, } AB/DE = BC/EF = CA/FD \dots\dots\dots(\text{ii})$$

$$\Rightarrow \frac{AB}{DE} = \frac{\frac{1}{2}BC}{\frac{1}{2}EF} = \frac{AM}{DN}$$

In $\triangle ABM$ and $\triangle DEN$,

Since $\triangle ABC \sim \triangle DEF$

$$\therefore \angle B = \angle E$$

$$AB/DE = BM/EN \text{ [Already Proved in equation (i)]}$$

$$\therefore \triangle ABM \sim \triangle DEN \text{ [SAS similarity criterion]}$$

$$\Rightarrow AB/DE = AM/DN \dots\dots\dots(\text{iii})$$

$$\therefore \triangle ABM \sim \triangle DEN$$

As the areas of two similar triangles are proportional to the squares of the corresponding sides.

$$\therefore \text{area}(\triangle ABC)/\text{area}(\triangle DEF) = AB^2/DE^2 = AM^2/DN^2$$

Hence, proved.

7. Prove that the area of an equilateral triangle described on one side of a square is equal to half the area of the equilateral triangle described on one of its diagonals.

Solution:

Given, ABCD is a square whose one diagonal is AC. $\triangle APC$ and $\triangle BQC$ are two equilateral triangles described on the diagonals AC and side BC of the square ABCD.

$$\text{Area}(\triangle BQC) = \frac{1}{2} \text{Area}(\triangle APC)$$

Since, $\triangle APC$ and $\triangle BQC$ are both equilateral triangles, as per given,

$$\therefore \triangle APC \sim \triangle BQC \text{ [AAA similarity criterion]}$$

$$\therefore \text{area}(\triangle APC)/\text{area}(\triangle BQC) = (AC^2/BC^2) = AC^2/BC^2$$

$$\text{Since, Diagonal} = \sqrt{2} \text{ side} = \sqrt{2} BC = AC$$

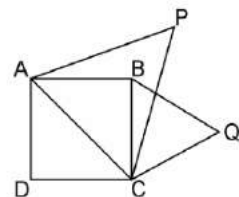

$$\left(\frac{\sqrt{2}BC}{BC}\right)^2 = 2$$

$$\Rightarrow \text{area}(\triangle APC) = 2 \times \text{area}(\triangle BQC)$$

$$\Rightarrow \text{area}(\triangle BQC) = 1/2 \text{area}(\triangle APC)$$

Hence, proved.

Tick the correct answer and justify:

8. ABC and BDE are two equilateral triangles such that D is the mid-point of BC. Ratio of the area of triangles ABC and BDE is

(A) 2 : 1

(B) 1 : 2

(C) 4 : 1

(D) 1 : 4

Solution:

Given, $\triangle ABC$ and $\triangle BDE$ are two equilateral triangle. D is the midpoint of BC.

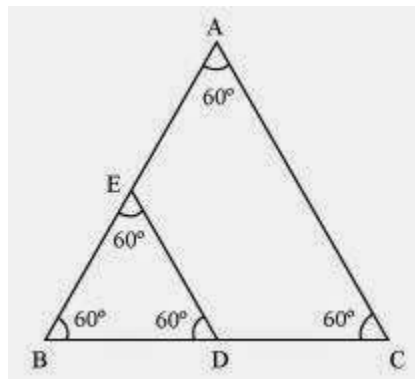

$$\therefore BD = DC = 1/2BC$$

Let each side of triangle is $2a$.

As, $\triangle ABC \sim \triangle BDE$

$$\therefore \text{Area}(\triangle ABC)/\text{Area}(\triangle BDE) = AB^2/BD^2 = (2a)^2/(a)^2 = 4a^2/a^2 = 4/1 = 4:1$$

Hence, the correct answer is (C).

9. Sides of two similar triangles are in the ratio 4 : 9. Areas of these triangles are in the ratio

(A) 2 : 3

(B) 4 : 9

(C) 81 : 16

(D) 16 : 81

Solution:

Given, Sides of two similar triangles are in the ratio 4 : 9.

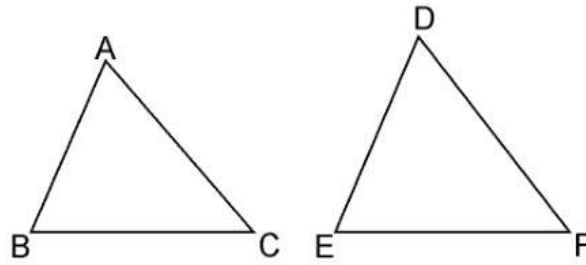

Let ABC and DEF are two similar triangles, such that,
 $\triangle ABC \sim \triangle DEF$

And $AB/DE = AC/DF = BC/EF = 4/9$

As, the ratio of the areas of these triangles will be equal to the square of the ratio of the corresponding sides,

$$\therefore \text{Area}(\triangle ABC)/\text{Area}(\triangle DEF) = AB^2/DE^2$$

$$\therefore \text{Area}(\triangle ABC)/\text{Area}(\triangle DEF) = (4/9)^2 = 16/81 = 16:81$$

Hence, the correct answer is (D).

Exercise 6.5

Page: 150

1. Sides of triangles are given below. Determine which of them are right triangles? In case of a right triangle, write the length of its hypotenuse.

(i) 7 cm, 24 cm, 25 cm

(ii) 3 cm, 8 cm, 6 cm

(iii) 50 cm, 80 cm, 100 cm

(iv) 13 cm, 12 cm, 5 cm

Solution:

(i) Given, sides of the triangle are 7 cm, 24 cm, and 25 cm.

Squaring the lengths of the sides of the, we will get 49, 576, and 625.

$$49 + 576 = 625$$

$$(7)^2 + (24)^2 = (25)^2$$

Therefore, the above equation satisfies, Pythagoras theorem. Hence, it is right angled triangle.

Length of Hypotenuse = 25 cm

(ii) Given, sides of the triangle are 3 cm, 8 cm, and 6 cm.

Squaring the lengths of these sides, we will get 9, 64, and 36.

Clearly, $9 + 36 \neq 64$

$$\text{Or, } 3^2 + 6^2 \neq 8^2$$

Therefore, the sum of the squares of the lengths of two sides is not equal to the square of the length of the hypotenuse.

Hence, the given triangle does not satisfies Pythagoras theorem.

(iii) Given, sides of triangle's are 50 cm, 80 cm, and 100 cm.

Squaring the lengths of these sides, we will get 2500, 6400, and 10000.

However, $2500 + 6400 \neq 10000$

$$\text{Or, } 50^2 + 80^2 \neq 100^2$$

As you can see, the sum of the squares of the lengths of two sides is not equal to the square of the length of the third side.

Therefore, the given triangle does not satisfies Pythagoras theorem.

Hence, it is not a right triangle.

(iv) Given, sides are 13 cm, 12 cm, and 5 cm.

Squaring the lengths of these sides, we will get 169, 144, and 25.

$$\text{Thus, } 144 + 25 = 169$$

$$\text{Or, } 12^2 + 5^2 = 13^2$$

The sides of the given triangle are satisfying Pythagoras theorem.

Therefore, it is a right triangle.

Hence, length of the hypotenuse of this triangle is 13 cm.

2. PQR is a triangle right angled at P and M is a point on QR such that $PM \perp QR$. Show that $PM^2 = QM \times MR$.

Solution:

Given, ΔPQR is right angled at P is a point on QR such that $PM \perp QR$

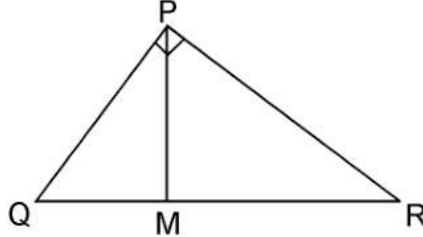

We have to prove, $PM^2 = QM \times MR$

In ΔPQM , by Pythagoras theorem

$$PQ^2 = PM^2 + QM^2$$

$$\text{Or, } PM^2 = PQ^2 - QM^2 \dots\dots\dots\text{(i)}$$

In ΔPMR , by Pythagoras theorem

$$PR^2 = PM^2 + MR^2$$

$$\text{Or, } PM^2 = PR^2 - MR^2 \dots\dots\dots\text{(ii)}$$

Adding equation, (i) and (ii), we get,

$$\begin{aligned} 2PM^2 &= (PQ^2 + PM^2) - (QM^2 + MR^2) \\ &= QR^2 - QM^2 - MR^2 \quad [\because QR^2 = PQ^2 + PR^2] \\ &= (QM + MR)^2 - QM^2 - MR^2 \\ &= 2QM \times MR \\ \therefore PM^2 &= QM \times MR \end{aligned}$$

3. In Figure, ABD is a triangle right angled at A and $AC \perp BD$. Show that

- (i) $AB^2 = BC \times BD$
- (ii) $AC^2 = BC \times DC$
- (iii) $AD^2 = BD \times CD$

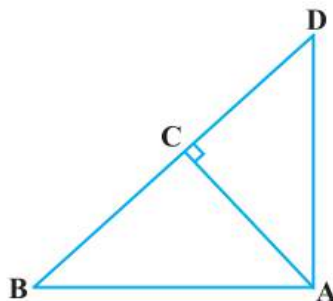

Solution:

(i) In $\triangle ADB$ and $\triangle CAB$,
 $\angle DAB = \angle ACB$ (Each 90°)
 $\angle ABD = \angle CBA$ (Common angles)
 $\therefore \triangle ADB \sim \triangle CAB$ [AA similarity criterion]
 $\Rightarrow AB/CB = BD/AB$
 $\Rightarrow AB^2 = CB \times BD$

(ii) Let $\angle CAB = x$
 In $\triangle CBA$,
 $\angle CBA = 180^\circ - 90^\circ - x$
 $\angle CBA = 90^\circ - x$
 Similarly, in $\triangle CAD$
 $\angle CAD = 90^\circ - \angle CBA$
 $= 90^\circ - x$
 $\angle CDA = 180^\circ - 90^\circ - (90^\circ - x)$
 $\angle CDA = x$

In $\triangle CBA$ and $\triangle CAD$, we have
 $\angle CBA = \angle CAD$
 $\angle CAB = \angle CDA$
 $\angle ACB = \angle DCA$ (Each 90°)
 $\therefore \triangle CBA \sim \triangle CAD$ [AAA similarity criterion]
 $\Rightarrow AC/DC = BC/AC$
 $\Rightarrow AC^2 = DC \times BC$

(iii) In $\triangle DCA$ and $\triangle DAB$,
 $\angle DCA = \angle DAB$ (Each 90°)
 $\angle CDA = \angle ADB$ (common angles)
 $\therefore \triangle DCA \sim \triangle DAB$ [AA similarity criterion]
 $\Rightarrow DC/DA = DA/DA$
 $\Rightarrow AD^2 = BD \times CD$

4. ABC is an isosceles triangle right angled at C. Prove that $AB^2 = 2AC^2$.

Solution:

Given, $\triangle ABC$ is an isosceles triangle right angled at C.

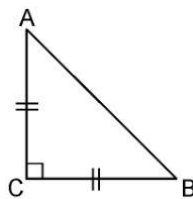

In $\triangle ACB$, $\angle C = 90^\circ$
 $AC = BC$ (By isosceles triangle property)

$$\begin{aligned}
 AB^2 &= AC^2 + BC^2 \text{ [By Pythagoras theorem]} \\
 &= AC^2 + AC^2 \text{ [Since, } AC = BC\text{]} \\
 AB^2 &= 2AC^2
 \end{aligned}$$

5. ABC is an isosceles triangle with $AC = BC$. If $AB^2 = 2AC^2$, prove that ABC is a right triangle.

Solution:

Given, ΔABC is an isosceles triangle having $AC = BC$ and $AB^2 = 2AC^2$

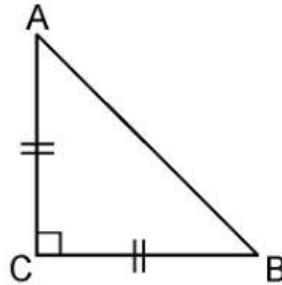

In ΔACB ,
 $AC = BC$
 $AB^2 = 2AC^2$
 $AB^2 = AC^2 + AC^2$
 $= AC^2 + BC^2$ [Since, $AC = BC$]
Hence, by Pythagoras theorem ΔABC is right angle triangle.

6. ABC is an equilateral triangle of side $2a$. Find each of its altitudes.

Solution:

Given, ABC is an equilateral triangle of side $2a$.

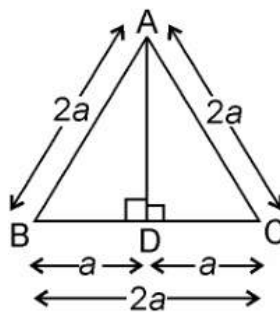

Draw, $AD \perp BC$
In ΔADB and ΔADC ,
 $AB = AC$
 $AD = AD$
 $\angle ADB = \angle ADC$ [Both are 90°]

Therefore, $\Delta ADB \cong \Delta ADC$ by RHS congruence.

Hence, $BD = DC$ [by CPCT]

In right angled $\triangle ADB$,
 $AB^2 = AD^2 + BD^2$
 $(2a)^2 = AD^2 + a^2$
 $\Rightarrow AD^2 = 4a^2 - a^2$
 $\Rightarrow AD^2 = 3a^2$
 $\Rightarrow AD = \sqrt{3}a$

7. Prove that the sum of the squares of the sides of rhombus is equal to the sum of the squares of its diagonals.

Solution:

Given, ABCD is a rhombus whose diagonals AC and BD intersect at O.

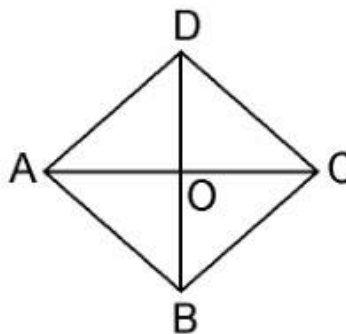

We have to prove, as per the question,
 $AB^2 + BC^2 + CD^2 + AD^2 = AC^2 + BD^2$

Since, the diagonals of a rhombus bisect each other at right angles.

Therefore, $AO = CO$ and $BO = DO$

In $\triangle AOB$,

$\angle AOB = 90^\circ$

$AB^2 = AO^2 + BO^2$ (i) [By Pythagoras theorem]

Similarly,

$AD^2 = AO^2 + DO^2$ (ii)

$DC^2 = DO^2 + CO^2$ (iii)

$BC^2 = CO^2 + BO^2$ (iv)

Adding equations (i) + (ii) + (iii) + (iv), we get,

$$\begin{aligned} AB^2 + AD^2 + DC^2 + BC^2 &= 2(AO^2 + BO^2 + DO^2 + CO^2) \\ &= 4AO^2 + 4BO^2 \text{ [Since, } AO = CO \text{ and } BO = DO\text{]} \\ &= (2AO)^2 + (2BO)^2 = AC^2 + BD^2 \end{aligned}$$

$$AB^2 + AD^2 + DC^2 + BC^2 = AC^2 + BD^2$$

Hence, proved.

8. In Fig. 6.54, O is a point in the interior of a triangle.

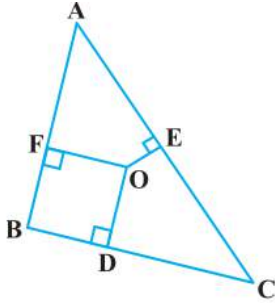

ABC, $OD \perp BC$, $OE \perp AC$ and $OF \perp AB$. Show that:

- (i) $OA^2 + OB^2 + OC^2 - OD^2 - OE^2 - OF^2 = AF^2 + BD^2 + CE^2$,
 (ii) $AF^2 + BD^2 + CE^2 = AE^2 + CD^2 + BF^2$.

Solution:

Given, in $\triangle ABC$, O is a point in the interior of a triangle.
 And $OD \perp BC$, $OE \perp AC$ and $OF \perp AB$.

Join OA, OB and OC

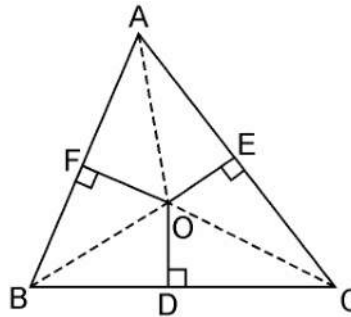

(i) By Pythagoras theorem in $\triangle AOF$, we have

$$OA^2 = OF^2 + AF^2$$

Similarly, in $\triangle BOD$

$$OB^2 = OD^2 + BD^2$$

Similarly, in $\triangle COE$

$$OC^2 = OE^2 + EC^2$$

Adding these equations,

$$OA^2 + OB^2 + OC^2 = OF^2 + AF^2 + OD^2 + BD^2 + OE^2 + EC^2$$

$$OA^2 + OB^2 + OC^2 - OD^2 - OE^2 - OF^2 = AF^2 + BD^2 + CE^2.$$

(ii) $AF^2 + BD^2 + EC^2 = (OA^2 - OE^2) + (OC^2 - OD^2) + (OB^2 - OF^2)$

$$\therefore AF^2 + BD^2 + CE^2 = AE^2 + CD^2 + BF^2.$$

9. A ladder 10 m long reaches a window 8 m above the ground. Find the distance of the foot of the ladder from base of the wall.

Solution:

Given, a ladder 10 m long reaches a window 8 m above the ground.

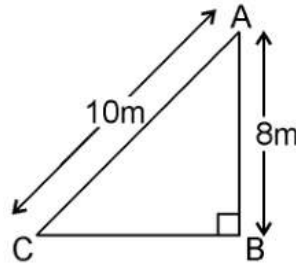

Let BA be the wall and AC be the ladder,

Therefore, by Pythagoras theorem,

$$AC^2 = AB^2 + BC^2$$

$$10^2 = 8^2 + BC^2$$

$$BC^2 = 100 - 64$$

$$BC^2 = 36$$

$$BC = 6\text{m}$$

Therefore, the distance of the foot of the ladder from the base of the wall is 6 m.

10. A guy wire attached to a vertical pole of height 18 m is 24 m long and has a stake attached to the other end. How far from the base of the pole should the stake be driven so that the wire will be taut?

Solution:

Given, a guy wire attached to a vertical pole of height 18 m is 24 m long and has a stake attached to the other end.

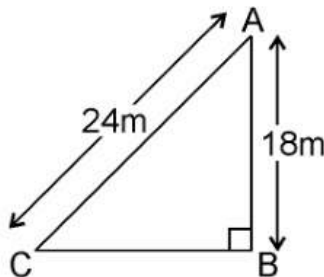

Let AB be the pole and AC be the wire.

By Pythagoras theorem,

$$AC^2 = AB^2 + BC^2$$

$$24^2 = 18^2 + BC^2$$

$$BC^2 = 576 - 324$$

$$BC^2 = 252$$

$$BC = 6\sqrt{7}\text{m}$$

Therefore, the distance from the base is $6\sqrt{7}\text{m}$.

11. An aeroplane leaves an airport and flies due north at a speed of 1,000 km per hour. At the same time, another aeroplane leaves the same airport and flies due west at a speed of 1,200 km per hour. How far apart will be the two planes after $1\frac{1}{2}$ hours?

Solution:

Given,

Speed of first aeroplane = 1000 km/hr

Distance covered by first aeroplane flying due north in $1\frac{1}{2}$ hours (OA) = $1000 \times \frac{3}{2}$ km = 1500 km

Speed of second aeroplane = 1200 km/hr

Distance covered by second aeroplane flying due west in $1\frac{1}{2}$ hours (OB) = $1200 \times \frac{3}{2}$ km = 1800 km

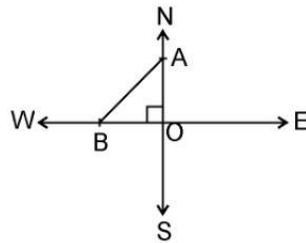

In right angle $\triangle AOB$, by Pythagoras Theorem,

$$AB^2 = AO^2 + OB^2$$

$$\Rightarrow AB^2 = (1500)^2 + (1800)^2$$

$$\Rightarrow AB = \sqrt{(2250000 + 3240000)}$$

$$= \sqrt{5490000}$$

$$\Rightarrow AB = 300\sqrt{61} \text{ km}$$

Hence, the distance between two aeroplanes will be $300\sqrt{61}$ km.

12. Two poles of heights 6 m and 11 m stand on a plane ground. If the distance between the feet of the poles is 12 m, find the distance between their tops.

Solution:

Given, Two poles of heights 6 m and 11 m stand on a plane ground.

And distance between the feet of the poles is 12 m.

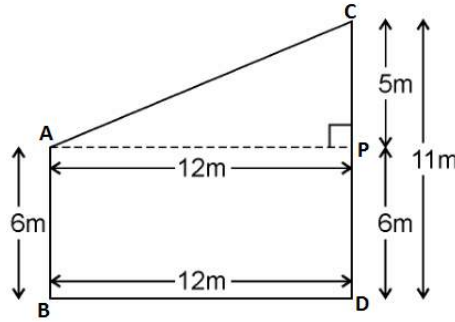

Let AB and CD be the poles of height 6m and 11m.
Therefore, $CP = 11 - 6 = 5\text{m}$

From the figure, it can be observed that $AP = 12\text{m}$

By Pythagoras theorem for ΔAPC , we get,

$$AP^2 = PC^2 + AC^2$$

$$(12\text{m})^2 + (5\text{m})^2 = (AC)^2$$

$$AC^2 = (144+25) \text{ m}^2 = 169 \text{ m}^2$$

$$AC = 13\text{m}$$

Therefore, the distance between their tops is 13 m.

13. D and E are points on the sides CA and CB respectively of a triangle ABC right angled at C. Prove that $AE^2 + BD^2 = AB^2 + DE^2$.

Solution:

Given, D and E are points on the sides CA and CB respectively of a triangle ABC right angled at C.

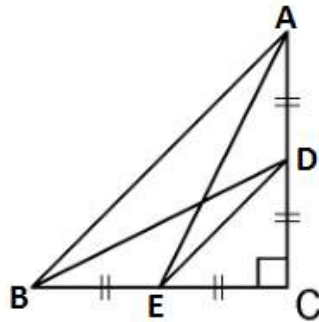

By Pythagoras theorem in ΔACE , we get

$$AC^2 + CE^2 = AE^2 \dots\dots\dots\text{(i)}$$

In ΔBCD , by Pythagoras theorem, we get

$$BC^2 + CD^2 = BD^2 \dots\dots\dots\text{(ii)}$$

From equations (i) and (ii), we get,

$$AC^2 + CE^2 + BC^2 + CD^2 = AE^2 + BD^2 \dots\dots\dots\text{(iii)}$$

In ΔCDE , by Pythagoras theorem, we get

$$DE^2 = CD^2 + CE^2$$

In ΔABC , by Pythagoras theorem, we get

$$AB^2 = AC^2 + CB^2$$

Putting the above two values in equation (iii), we get

$$DE^2 + AB^2 = AE^2 + BD^2.$$

14. The perpendicular from A on side BC of a ΔABC intersects BC at D such that $DB = 3CD$ (see Figure). Prove that $2AB^2 = 2AC^2 + BC^2$.

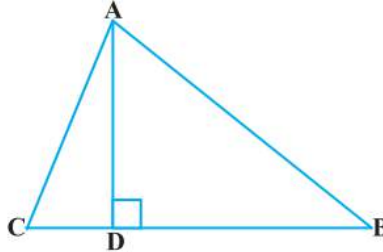

Solution:

Given, the perpendicular from A on side BC of a ΔABC intersects BC at D such that;
 $DB = 3CD$.

In ΔABC ,

$AD \perp BC$ and $BD = 3CD$

In right angle triangle, ADB and ADC, by Pythagoras theorem,

$$AB^2 = AD^2 + BD^2 \dots\dots\dots\text{(i)}$$

$$AC^2 = AD^2 + DC^2 \dots\dots\dots\text{(ii)}$$

Subtracting equation (ii) from equation (i), we get

$$AB^2 - AC^2 = BD^2 - DC^2$$

$$= 9CD^2 - CD^2 \text{ [Since, } BD = 3CD]$$

$$= 8CD^2$$

$$= 8(BC/4)^2 \text{ [Since, } BC = DB + CD = 3CD + CD = 4CD]$$

Therefore, $AB^2 - AC^2 = BC^2/2$

$$\Rightarrow 2(AB^2 - AC^2) = BC^2$$

$$\Rightarrow 2AB^2 - 2AC^2 = BC^2$$

$$\therefore 2AB^2 = 2AC^2 + BC^2.$$

15. In an equilateral triangle ABC, D is a point on side BC such that $BD = 1/3BC$. Prove that $9AD^2 = 7AB^2$.

Solution:

Given, ABC is an equilateral triangle.

And D is a point on side BC such that $BD = 1/3BC$

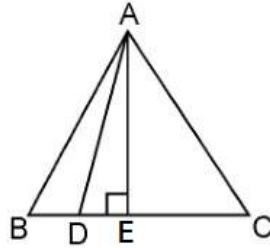

Let the side of the equilateral triangle be a , and AE be the altitude of $\triangle ABC$.

$$\therefore BE = EC = BC/2 = a/2$$

$$\text{And, } AE = a\sqrt{3}/2$$

$$\text{Given, } BD = 1/3BC$$

$$\therefore BD = a/3$$

$$DE = BE - BD = a/2 - a/3 = a/6$$

In $\triangle ADE$, by Pythagoras theorem,

$$AD^2 = AE^2 + DE^2$$

$$\begin{aligned} AD^2 &= \left(\frac{a\sqrt{3}}{2}\right)^2 + \left(\frac{a}{6}\right)^2 \\ &= \left(\frac{3a^2}{4}\right) + \left(\frac{a^2}{36}\right) \\ &= \frac{28a^2}{36} \\ &= \frac{7}{9}AB^2 \end{aligned}$$

$$\Rightarrow 9 AD^2 = 7 AB^2$$

16. In an equilateral triangle, prove that three times the square of one side is equal to four times the square of one of its altitudes.

Solution:

Given, an equilateral triangle say ABC ,

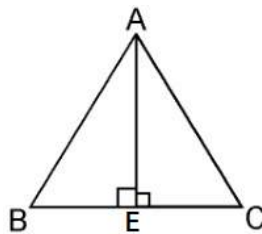

Let the sides of the equilateral triangle be of length a , and AE be the altitude of $\triangle ABC$.

$$\therefore BE = EC = BC/2 = a/2$$

In $\triangle ABE$, by Pythagoras Theorem, we get

$$AB^2 = AE^2 + BE^2$$

$$a^2 = AE^2 + \left(\frac{a}{2}\right)^2$$

$$AE^2 = a^2 - \frac{a^2}{4}$$

$$AE^2 = \frac{3a^2}{4}$$

$$4AE^2 = 3a^2$$

$$\Rightarrow 4 \times (\text{Square of altitude}) = 3 \times (\text{Square of one side})$$

Hence, proved.

17. Tick the correct answer and justify: In $\triangle ABC$, $AB = 6\sqrt{3}$ cm, $AC = 12$ cm and $BC = 6$ cm. The angle B is:

(A) 120°

(B) 60°

(C) 90°

(D) 45°

Solution:

Given, in $\triangle ABC$, $AB = 6\sqrt{3}$ cm, $AC = 12$ cm and $BC = 6$ cm.

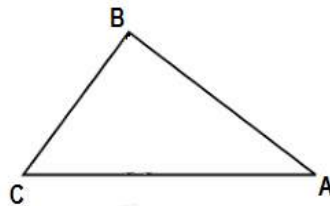

We can observe that,

$$AB^2 = 108$$

$$AC^2 = 144$$

$$\text{And, } BC^2 = 36$$

$$AB^2 + BC^2 = AC^2$$

The given triangle, $\triangle ABC$, is satisfying Pythagoras theorem.

Therefore, the triangle is a right triangle, right-angled at B.

$$\therefore \angle B = 90^\circ$$

Hence, the correct answer is (C).

Exercise 6.6

1. In Figure, PS is the bisector of $\angle QPR$ of ΔPQR . Prove that $QS/PQ = SR/PR$

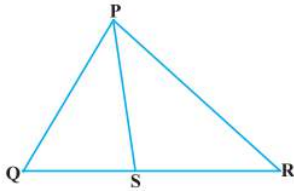

Solution:

Let us draw a line segment RT parallel to SP which intersects extended line segment QP at point T.

Given, PS is the angle bisector of $\angle QPR$. Therefore,
 $\angle QPS = \angle SPR$(i)

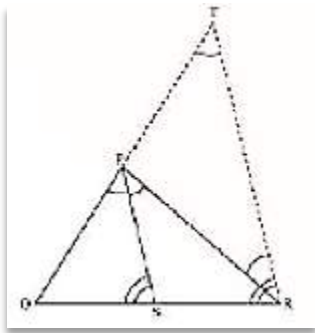

As per the constructed figure,
 $\angle SPR = \angle PRT$ (Since, $PS \parallel TR$).....(ii)
 $\angle QPS = \angle QRT$ (Since, $PS \parallel TR$)(iii)
 From the above equations, we get,
 $\angle PRT = \angle QTR$
 Therefore,
 $PT = PR$

In ΔQTR , by basic proportionality theorem,
 $QS/SR = QP/PT$
 Since, $PT = PR$
 Therefore,
 $QS/SR = PQ/PR$
 Hence, proved.

2. In Fig. 6.57, D is a point on hypotenuse AC of $\triangle ABC$, such that $BD \perp AC$, $DM \perp BC$ and $DN \perp AB$. Prove

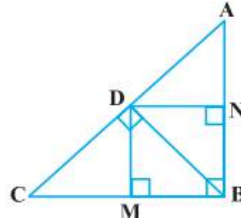

that: (i) $DM^2 = DN \cdot MC$ (ii) $DN^2 = DM \cdot AN$.

Solution:

(i) Let us join Point D and B.

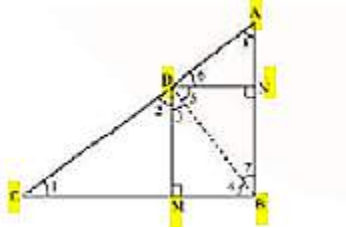

Given,

$BD \perp AC$, $DM \perp BC$ and $DN \perp AB$

Now from the figure we have,

$DN \parallel CB$, $DM \parallel AB$ and $\angle B = 90^\circ$

Therefore, $DMBN$ is a rectangle.

So, $DN = MB$ and $DM = NB$

The given condition which we have to prove, is when D is the foot of the perpendicular drawn from B to AC.

$$\therefore \angle CDB = 90^\circ \Rightarrow \angle 2 + \angle 3 = 90^\circ \dots\dots\dots (i)$$

$$\text{In } \triangle CDM, \angle 1 + \angle 2 + \angle DMC = 180^\circ$$

$$\Rightarrow \angle 1 + \angle 2 = 90^\circ \dots\dots\dots (ii)$$

$$\text{In } \triangle DMB, \angle 3 + \angle DMB + \angle 4 = 180^\circ$$

$$\Rightarrow \angle 3 + \angle 4 = 90^\circ \dots\dots\dots (iii)$$

From equation (i) and (ii), we get

$$\angle 1 = \angle 3$$

From equation (i) and (iii), we get

$$\angle 2 = \angle 4$$

In $\triangle DCM$ and $\triangle BDM$,

$$\angle 1 = \angle 3 \text{ (Already Proved)}$$

$$\angle 2 = \angle 4 \text{ (Already Proved)}$$

$\therefore \triangle DCM \sim \triangle BDM$ (AA similarity criterion)

$$BM/DM = DM/MC$$

$$\Rightarrow DN/DM = DM/MC \quad (BM = DN)$$

$$\Rightarrow DM^2 = DN \times MC$$

Hence, proved.

(ii) In right triangle DBN,

$$\angle 5 + \angle 7 = 90^\circ \dots\dots\dots (iv)$$

In right triangle DAN,

$$\angle 6 + \angle 8 = 90^\circ \dots\dots\dots (v)$$

D is the point in triangle, which is foot of the perpendicular drawn from B to AC.

$$\therefore \angle ADB = 90^\circ \Rightarrow \angle 5 + \angle 6 = 90^\circ \dots\dots\dots (vi)$$

From equation (iv) and (vi), we get,

$$\angle 6 = \angle 7$$

From equation (v) and (vi), we get,

$$\angle 8 = \angle 5$$

In $\triangle DNA$ and $\triangle BND$,

$$\angle 6 = \angle 7 \text{ (Already proved)}$$

$$\angle 8 = \angle 5 \text{ (Already proved)}$$

$\therefore \triangle DNA \sim \triangle BND$ (AA similarity criterion)

$$AN/DN = DN/NB$$

$$\Rightarrow DN^2 = AN \times NB$$

$$\Rightarrow DN^2 = AN \times DM \text{ (Since, } NB = DM)$$

Hence, proved.

3. In Figure, ABC is a triangle in which $\angle ABC > 90^\circ$ and $AD \perp CB$ produced. Prove that $AC^2 = AB^2 + BC^2 + 2 BC \cdot BD$.

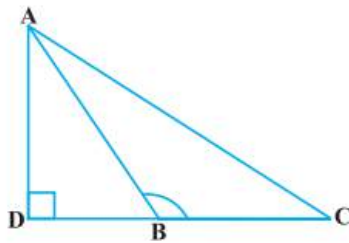

Solution:

By applying Pythagoras Theorem in $\triangle ADB$, we get,

$$AB^2 = AD^2 + DB^2 \dots\dots\dots (i)$$

Again, by applying Pythagoras Theorem in $\triangle ACD$, we get,

$$AC^2 = AD^2 + DC^2$$

$$AC^2 = AD^2 + (DB + BC)^2$$

$$AC^2 = AD^2 + DB^2 + BC^2 + 2DB \times BC$$

From equation (i), we can write,

$$AC^2 = AB^2 + BC^2 + 2DB \times BC$$

Hence, proved.

4. In Figure, ABC is a triangle in which $\angle ABC < 90^\circ$ and $AD \perp BC$. Prove that $AC^2 = AB^2 + BC^2 - 2 BC \cdot BD$.

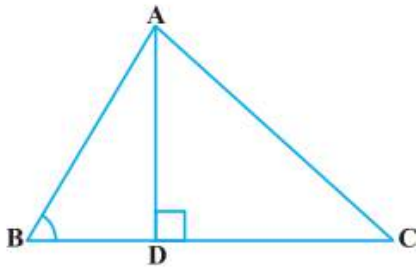

Solution:

By applying Pythagoras Theorem in $\triangle ADB$, we get,

$$AB^2 = AD^2 + DB^2$$

We can write it as;

$$\Rightarrow AD^2 = AB^2 - DB^2 \dots\dots\dots (i)$$

By applying Pythagoras Theorem in $\triangle ADC$, we get,

$$AD^2 + DC^2 = AC^2$$

From equation (i),

$$AB^2 - BD^2 + DC^2 = AC^2$$

$$AB^2 - BD^2 + (BC - BD)^2 = AC^2$$

$$AC^2 = AB^2 - BD^2 + BC^2 + BD^2 - 2BC \times BD$$

$$AC^2 = AB^2 + BC^2 - 2BC \times BD$$

Hence, proved.

5. In Figure, AD is a median of a triangle ABC and $AM \perp BC$. Prove that :

(i) $AC^2 = AD^2 + BC \cdot DM + 2 \left(\frac{BC}{2}\right)^2$

(ii) $AB^2 = AD^2 - BC \cdot DM + 2 \left(\frac{BC}{2}\right)^2$

(iii) $AC^2 + AB^2 = 2AD^2 + \frac{1}{2}BC^2$

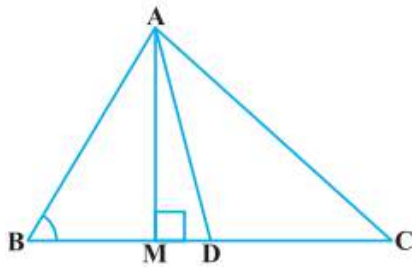

Solution:

(i) By applying Pythagoras Theorem in $\triangle AMD$, we get,

$$AM^2 + MD^2 = AD^2 \dots\dots\dots (i)$$

Again, by applying Pythagoras Theorem in $\triangle AMC$, we get,

$$AM^2 + MC^2 = AC^2$$

$$AM^2 + (MD + DC)^2 = AC^2$$

$$(AM^2 + MD^2) + DC^2 + 2MD \cdot DC = AC^2$$

From equation(i), we get,

$$AD^2 + DC^2 + 2MD.DC = AC^2$$

Since, $DC=BC/2$, thus, we get,

$$AD^2 + (BC/2)^2 + 2MD.(BC/2) = AC^2$$

$$AD^2 + (BC/2)^2 + 2MD \times BC = AC^2$$

Hence, proved.

(ii) By applying Pythagoras Theorem in ΔABM , we get;

$$AB^2 = AM^2 + MB^2$$

$$= (AD^2 - DM^2) + MB^2$$

$$= (AD^2 - DM^2) + (BD - MD)^2$$

$$= AD^2 - DM^2 + BD^2 + MD^2 - 2BD \times MD$$

$$= AD^2 + BD^2 - 2BD \times MD$$

$$= AD^2 + (BC/2)^2 - 2(BC/2) \times MD$$

$$= AD^2 + (BC/2)^2 - BC \times MD$$

Hence, proved.

(iii) By applying Pythagoras Theorem in ΔABM , we get,

$$AM^2 + MB^2 = AB^2 \dots\dots\dots (i)$$

By applying Pythagoras Theorem in ΔAMC , we get,

$$AM^2 + MC^2 = AC^2 \dots\dots\dots (ii)$$

Adding both the equations (i) and (ii), we get,

$$2AM^2 + MB^2 + MC^2 = AB^2 + AC^2$$

$$2AM^2 + (BD - DM)^2 + (MD + DC)^2 = AB^2 + AC^2$$

$$2AM^2 + BD^2 + DM^2 - 2BD.DM + MD^2 + DC^2 + 2MD.DC = AB^2 + AC^2$$

$$2AM^2 + 2MD^2 + BD^2 + DC^2 + 2MD(-BD + DC) = AB^2 + AC^2$$

$$2(AM^2 + MD^2) + (BC/2)^2 + (BC/2)^2 + 2MD(-BC/2 + BC/2) = AB^2 + AC^2$$

$$2AD^2 + BC^2/2 = AB^2 + AC^2$$

6. Prove that the sum of the squares of the diagonals of parallelogram is equal to the sum of the squares of its sides.

Solution:

Let us consider, ABCD be a parallelogram. Now, draw perpendicular DE on extended side of AB, and draw a perpendicular AF meeting DC at point F.

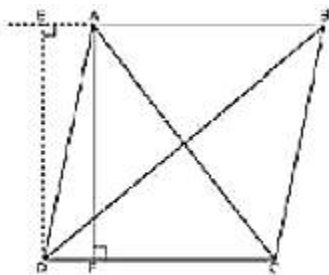

By applying Pythagoras Theorem in $\triangle DEA$, we get,

$$DE^2 + EA^2 = DA^2 \dots\dots\dots (i)$$

By applying Pythagoras Theorem in $\triangle DEB$, we get,

$$DE^2 + EB^2 = DB^2$$

$$DE^2 + (EA + AB)^2 = DB^2$$

$$(DE^2 + EA^2) + AB^2 + 2EA \times AB = DB^2$$

$$DA^2 + AB^2 + 2EA \times AB = DB^2 \dots\dots\dots (ii)$$

By applying Pythagoras Theorem in $\triangle ADF$, we get,

$$AD^2 = AF^2 + FD^2$$

Again, applying Pythagoras theorem in $\triangle AFC$, we get,

$$AC^2 = AF^2 + FC^2 = AF^2 + (DC - FD)^2$$

$$= AF^2 + DC^2 + FD^2 - 2DC \times FD$$

$$= (AF^2 + FD^2) + DC^2 - 2DC \times FD$$

$$AC^2 = AD^2 + DC^2 - 2DC \times FD \dots\dots\dots (iii)$$

Since ABCD is a parallelogram,

$$AB = CD \dots\dots\dots (iv)$$

$$\text{And } BC = AD \dots\dots\dots (v)$$

In $\triangle DEA$ and $\triangle ADF$,

$$\angle DEA = \angle AFD \text{ (Each } 90^\circ)$$

$$\angle EAD = \angle ADF \text{ (EA } \parallel \text{ DF)}$$

$$AD = AD \text{ (Common Angles)}$$

$$\therefore \triangle EAD \cong \triangle FDA \text{ (AAS congruence criterion)}$$

$$\Rightarrow EA = DF \dots\dots\dots (vi)$$

Adding equations (i) and (iii), we get,

$$DA^2 + AB^2 + 2EA \times AB + AD^2 + DC^2 - 2DC \times FD = DB^2 + AC^2$$

$$DA^2 + AB^2 + AD^2 + DC^2 + 2EA \times AB - 2DC \times FD = DB^2 + AC^2$$

From equation (iv) and (vi),

$$BC^2 + AB^2 + AD^2 + DC^2 + 2EA \times AB - 2AB \times EA = DB^2 + AC^2$$

$$AB^2 + BC^2 + CD^2 + DA^2 = AC^2 + BD^2$$

7. In Figure, two chords AB and CD intersect each other at the point P. Prove that :

(i) $\triangle APC \sim \triangle DPB$

(ii) $AP \cdot PB = CP \cdot DP$

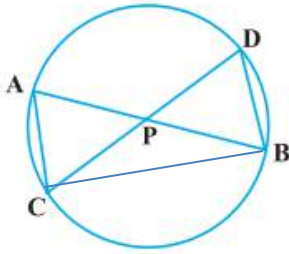
Solution:

Firstly, let us join CB, in the given figure.

- (i) In $\triangle APC$ and $\triangle DPB$,
 $\angle APC = \angle DPB$ (Vertically opposite angles)
 $\angle CAP = \angle BDP$ (Angles in the same segment for chord CB)
 Therefore,
 $\triangle APC \sim \triangle DPB$ (AA similarity criterion)

- (ii) In the above, we have proved that $\triangle APC \sim \triangle DPB$

We know that the corresponding sides of similar triangles are proportional.

$$\therefore AP/DP = PC/PB = CA/BD$$

$$\Rightarrow AP/DP = PC/PB$$

$$\therefore AP \cdot PB = PC \cdot DP$$

Hence, proved.

8. In Fig. 6.62, two chords AB and CD of a circle intersect each other at the point P (when produced) outside the circle. Prove that:

- (i) $\triangle PAC \sim \triangle PDB$
 (ii) $PA \cdot PB = PC \cdot PD$.

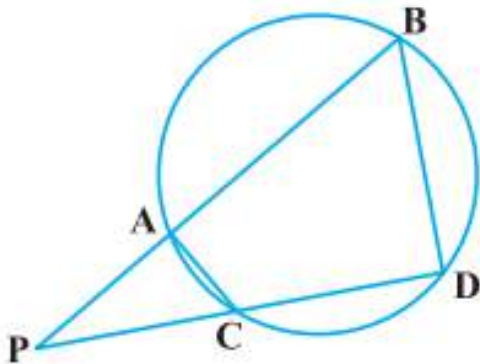
Solution:

- (i) In $\triangle PAC$ and $\triangle PDB$,

$\angle P = \angle P$ (Common Angles)

As we know, exterior angle of a cyclic quadrilateral is $\angle PCA$ and $\angle PBD$ is opposite interior angle, which are both equal.

$\angle PAC = \angle PDB$

Thus, $\Delta PAC \sim \Delta PDB$ (AA similarity criterion)

(ii) We have already proved above,

$\Delta APC \sim \Delta DPB$

We know that the corresponding sides of similar triangles are proportional.

Therefore,

$AP/DP = PC/PB = CA/BD$

$AP/DP = PC/PB$

$\therefore AP \cdot PB = PC \cdot DP$

9. In Figure, D is a point on side BC of ΔABC such that $BD/CD = AB/AC$. Prove that AD is the bisector of $\angle BAC$.

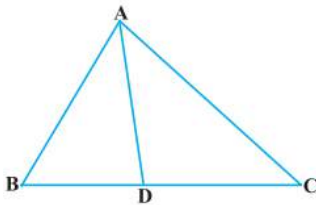

Solution:

In the given figure, let us extend BA to P such that;

$AP = AC$.

Now join PC.

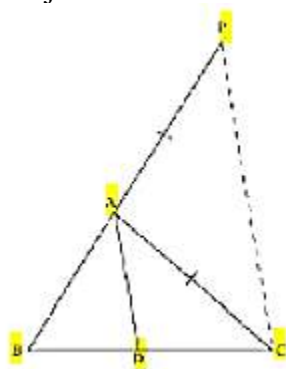

Given, $BD/CD = AB/AC$

$\Rightarrow BD/CD = AP/AC$

By using the converse of basic proportionality theorem, we get,

$AD \parallel PC$

$\angle BAD = \angle APC$ (Corresponding angles) (i)

And, $\angle DAC = \angle ACP$ (Alternate interior angles) (ii)

By the new figure, we have;

$$AP = AC$$

$$\Rightarrow \angle APC = \angle ACP \dots\dots\dots (iii)$$

On comparing equations (i), (ii), and (iii), we get,

$$\angle BAD = \angle APC$$

Therefore, AD is the bisector of the angle BAC.

Hence, proved.

10. Nazima is fly fishing in a stream. The tip of her fishing rod is 1.8 m above the surface of the water and the fly at the end of the string rests on the water 3.6 m away and 2.4 m from a point directly under the tip of the rod. Assuming that her string (from the tip of her rod to the fly) is taut, how much string does she have out (see Figure)? If she pulls in the string at the rate of 5 cm per second, what will be the horizontal distance of the fly from her after 12 seconds?

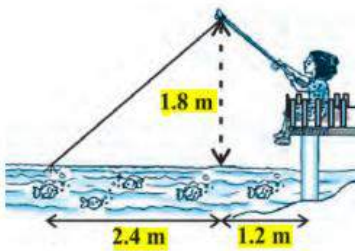

Solution:

Let us consider, AB is the height of the tip of the fishing rod from the water surface and BC is the horizontal distance of the fly from the tip of the fishing rod. Therefore, AC is now the length of the string.

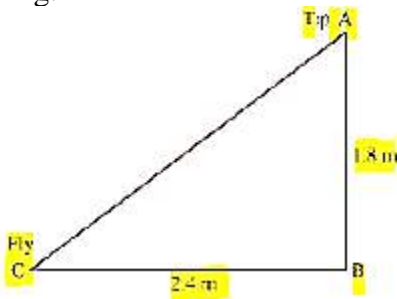

To find AC, we have to use Pythagoras theorem in $\triangle ABC$, is such way;

$$AC^2 = AB^2 + BC^2$$

$$AB^2 = (1.8 \text{ m})^2 + (2.4 \text{ m})^2$$

$$AB^2 = (3.24 + 5.76) \text{ m}^2$$

$$AB^2 = 9.00 \text{ m}^2$$

$$\Rightarrow AB = \sqrt{9} \text{ m} = 3 \text{ m}$$

Thus, the length of the string out is 3 m.

As its given, she pulls the string at the rate of 5 cm per second.

Therefore, string pulled in 12 seconds = $12 \times 5 = 60 \text{ cm} = 0.6 \text{ m}$

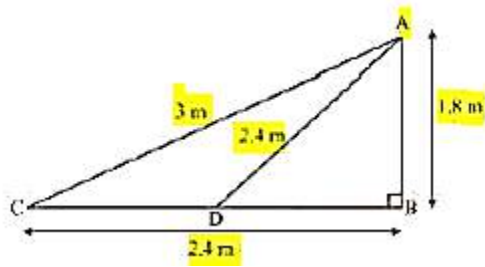

Let us say now, the fly is at point D after 12 seconds.

Length of string out after 12 seconds is AD.

$AD = AC - \text{String pulled by Nazima in 12 seconds}$

$$= (3.00 - 0.6) \text{ m}$$

$$= 2.4 \text{ m}$$

In $\triangle ADB$, by Pythagoras Theorem,

$$AB^2 + BD^2 = AD^2$$

$$(1.8 \text{ m})^2 + BD^2 = (2.4 \text{ m})^2$$

$$BD^2 = (5.76 - 3.24) \text{ m}^2 = 2.52 \text{ m}^2$$

$$BD = 1.587 \text{ m}$$

Horizontal distance of fly = $BD + 1.2 \text{ m}$

$$= (1.587 + 1.2) \text{ m} = 2.787 \text{ m}$$

$$= 2.79 \text{ m}$$