

XE : ENGINEERING SCIENCES

Duration: Three Hours

Maximum Marks: 100

Read the following instructions carefully.

1. Write your name and registration number in the space provided at the bottom of this page.
2. Take out the **Optical Response Sheet (ORS)** from this Question Booklet **without breaking the seal**.
3. Do not open the seal of the Question Booklet until you are asked to do so by the invigilator.
4. Write your registration number, your name and name of the examination centre at the specified locations on the right half of the **ORS**. Also, using HB pencil, darken the appropriate bubble under each digit of your registration number and the letters corresponding to your test paper code (XE).
5. This Question Booklet contains **36** pages including blank pages for rough work. After opening the seal at the specified time, please check all pages and report discrepancy, if any.
6. You can answer a maximum of 65 questions carrying 100 marks. Questions must be answered on the left hand side of the **ORS** by darkening the appropriate bubble (marked A, B, C, D) using HB pencil against the question number. **For each question darken the bubble of the correct answer.** In case you wish to change an answer, erase the old answer completely. More than one answer bubbled against a question will be treated as an incorrect response.
7. This Question Booklet contains **Eight** sections as listed below.

Section	Page No.	Section	Page No.
GA: <i>General Aptitude</i>	02	D. Solid Mechanics	16
A. <i>Engineering Mathematics</i>	04	E. Thermodynamics	21
B. Fluid Mechanics	07	F. Polymer Science & Engineering	25
C. Material Science	12	G. Food Technology	29

8. Section GA (General Aptitude) and Section A (Engineering Mathematics) are compulsory. Choose **two** more sections from the remaining sections with codes **B** through **G**. Using HB pencil, mark the codes of the sections you have chosen by darkening the appropriate bubbles on the left hand side of the **ORS** provided. **Make sure you have correctly bubbled the codes of the sections you have chosen. ORS will not be evaluated if this information is NOT marked.**
9. There are 10 questions carrying 15 marks in General Aptitude (GA) section, which is compulsory. Questions Q.1–Q.5 carry 1-mark each, and questions Q.6–Q.10 carry 2-marks each.
10. There are 11 questions carrying 15 marks in Section A (Engineering Mathematics), which is compulsory. Questions Q.1–Q.7 carry 1-mark each and questions Q.8–Q.11 carry 2-marks each.
11. Each of the other sections (Sections B through G) contains 22 questions carrying 35 marks. Questions Q.1–Q.9 carry 1-mark each and questions Q.10–Q.22 carry 2-marks each. Questions Q.17–Q.20 (2 pairs) are common data questions. Questions Q.21 and Q.22 (1 pair) are linked answer questions. The answer to the second question of the pair of linked answer questions depends on the answer to the first question of the pair. If the first question in the linked pair is wrongly answered or is unattempted, then the answer to the second question in the pair will not be evaluated.
12. Unattempted questions will result in zero marks and wrong answers will result in **NEGATIVE** marks. In GA, for Q.1–Q.5, $\frac{1}{3}$ mark will be deducted for each wrong answer and for Q.6–Q.10, $\frac{1}{2}$ mark will be deducted for each wrong answer. In Section A, for Q.1 – Q.7, $\frac{1}{3}$ mark will be deducted for each wrong answer and for Q.8–Q.11, $\frac{1}{2}$ mark will be deducted for each wrong answer. In all other section papers (Sections B through G), for Q.1–Q.9, $\frac{1}{3}$ mark will be deducted for each wrong answer and for Q.10–Q.20, $\frac{1}{2}$ mark will be deducted for each wrong answer. The question pair (Q.21, Q.22) is questions with linked answers. There will be negative marks only for wrong answer to the first question of the linked answer question pair i.e., for Q.21, $\frac{1}{3}$ mark will be deducted for wrong answer. There is no negative mark for Q.22.
13. Calculator is allowed whereas charts, graph sheets or tables are **NOT** allowed in the examination hall.

Name							
Registration Number	XE						

GA : General Aptitude (Compulsory)**Q. 1 – Q. 5 carry one mark each.**

- Q.1 Choose the most appropriate word from the options given below to complete the following sentence:
Under ethical guidelines recently adopted by the Indian Medical Association, human genes are to be manipulated only to correct diseases for which _____ treatments are unsatisfactory.
- (A) similar
(B) most
(C) uncommon
(D) available
- Q.2 Choose the word from the options given below that is most nearly opposite in meaning to the given word:
Frequency
- (A) periodicity
(B) rarity
(C) gradualness
(D) persistency
- Q.3 Choose the most appropriate word from the options given below to complete the following sentence:
It was her view that the country's problems had been _____ by foreign technocrats, so that to invite them to come back would be counter-productive.
- (A) identified
(B) ascertained
(C) exacerbated
(D) analysed
- Q.4 There are two candidates P and Q in an election. During the campaign, 40% of the voters promised to vote for P, and rest for Q. However, on the day of election 15% of the voters went back on their promise to vote for P and instead voted for Q. 25% of the voters went back on their promise to vote for Q and instead voted for P. Suppose, P lost by 2 votes, then what was the total number of voters?
- (A) 100 (B) 110 (C) 90 (D) 95
- Q.5 The question below consists of a pair of related words followed by four pairs of words. Select the pair that best expresses the relation in the original pair:
Gladiator : Arena
- (A) dancer : stage
(B) commuter : train
(C) teacher : classroom
(D) lawyer : courtroom

Q. 6 to Q. 10 carry two marks each.

- Q.6 The sum of n terms of the series $4+44+444+\dots$ is
- (A) $(4/81) [10^{n+1} - 9n - 1]$
(B) $(4/81) [10^{n-1} - 9n - 1]$
(C) $(4/81) [10^{n+1} - 9n - 10]$
(D) $(4/81) [10^n - 9n - 10]$

- Q.7 Given that $f(y) = |y|/y$, and q is any non-zero real number, the value of $|f(q) - f(-q)|$ is
 (A) 0 (B) -1 (C) 1 (D) 2
- Q.8 Three friends, R, S and T shared toffee from a bowl. R took $1/3^{\text{rd}}$ of the toffees, but returned four to the bowl. S took $1/4^{\text{th}}$ of what was left but returned three toffees to the bowl. T took half of the remainder but returned two back into the bowl. If the bowl had 17 toffees left, how many toffees were originally there in the bowl?
 (A) 38 (B) 31 (C) 48 (D) 41
- Q.9 The fuel consumed by a motorcycle during a journey while traveling at various speeds is indicated in the graph below.

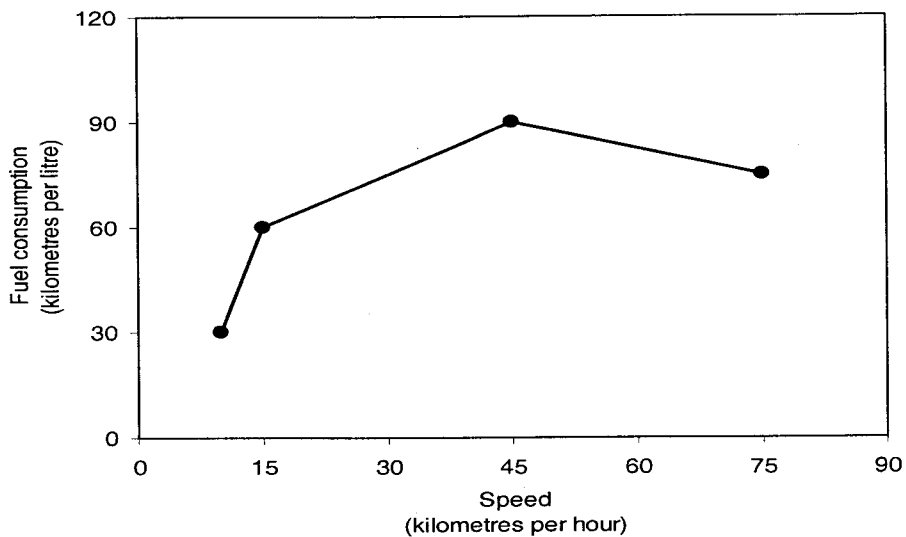

The distances covered during four laps of the journey are listed in the table below

Lap	Distance (kilometres)	Average speed (kilometres per hour)
P	15	15
Q	75	45
R	40	75
S	10	10

From the given data, we can conclude that the fuel consumed per kilometre was least during the lap

- (A) P (B) Q (C) R (D) S
- Q.10 **The horse has played a little known but very important role in the field of medicine. Horses were injected with toxins of diseases until their blood built up immunities. Then a serum was made from their blood. Serums to fight with diphtheria and tetanus were developed this way.**

It can be inferred from the passage, that horses were

- (A) given immunity to diseases
 (B) generally quite immune to diseases
 (C) given medicines to fight toxins
 (D) given diphtheria and tetanus serums

END OF SECTION – GA

A : ENGINEERING MATHEMATICS (Compulsory)

Q. 1 – Q. 7 carry one mark each.

Q.1 A vector field is called *solenoidal* if its divergence is zero. Consider the vector fields \vec{P} and \vec{Q} given by

$$\vec{P}(x, y, z) = (2x^2 + 8xy^2z)\hat{i} + (3x^3y - 3xy)\hat{j} - (4y^2z^2 + 2x^3z)\hat{k} \text{ and}$$

$$\vec{Q}(x, y, z) = xyz^2\vec{P}(x, y, z).$$

Then

- (A) \vec{P} and \vec{Q} are both solenoidal (B) both \vec{P} and \vec{Q} are not solenoidal
 (C) \vec{P} is solenoidal but not \vec{Q} (D) \vec{Q} is solenoidal but not \vec{P}

Q.2 The eigenvalues of a 3×3 matrix P are 2, 2 and -1 . Then P^{-1} is equal to

- (A) $\frac{1}{4}(3P - P^2)$ (B) $\frac{1}{2}(P^2 - 2P)$ (C) $-\frac{1}{2}(P^2 + 3P)$ (D) $-\frac{1}{4}(P^2 + 2P)$

Q.3 The integral $\int_{-5\pi/2}^{5\pi/2} f(x)dx$, where $f(x) = e^{\pi x^2} \sin^3 x + 4\cos x$, equals

- (A) 4 (B) 8 (C) $\frac{5\pi}{2}$ (D) $-\frac{5\pi}{2}$

Q.4 The integral $\oint_C \frac{z^3 e^z}{(z-1)^3} dz$ along the curve $C: |z| = \frac{\pi}{2}$, oriented counter-clockwise, equals

- (A) 0 (B) $2\pi i$ (C) $13\pi i$ (D) $20\pi i$

Q.5 Consider the function $f(x, y, z) = x^3 e^y \sin z$ and the point $P = \left(1, 0, \frac{\pi}{2}\right)$. The value of f **DOES NOT** change due to a small displacement of P along the direction of

- (A) $\left[1, 0, \frac{\pi}{2}\right]$ (B) $[1, -1, 1]$
 (C) $[1, -3, 0]$ (D) $[2, 0, -1]$

Q.6 A solution of the differential equation $\frac{d^2y}{dx^2} - 5\frac{dy}{dx} + 6y = 36x$ is

- (A) $e^{2x} + e^{3x} + 6x + 5$ (B) $e^{-3x} + 6x + 5$
 (C) $e^{2x} + e^{-3x} + 6x + \frac{5}{6}$ (D) $e^{2x} + e^{3x} + x + \frac{5}{6}$

Q.7 For any positive numbers a and b , the matrix

$$P = \begin{bmatrix} 1 \\ a \\ b \end{bmatrix} \begin{bmatrix} 4 & 5 & 6 \end{bmatrix} \text{ is}$$

- (A) orthogonal (B) diagonalizable
(C) nonsingular (D) of rank 2

Q. 8 - Q. 11 carry two marks each.

Q.8 Suppose x_n is the n -th iterated value while finding the positive square root of 7 by the Newton-Raphson method with a positive initial guess x_0 ($\neq \sqrt{7}$). If $e_n = \sqrt{7} - x_n$ for $n \geq 1$, then

- (A) $e_{n+1} = \frac{e_n}{2x_n^2}$ (B) $e_{n+1} = \frac{-\sqrt{7} e_n^2}{2x_n}$
(C) $e_{n+1} = \frac{e_n^2}{\sqrt{7}}$ (D) $e_{n+1} = \frac{-e_n^2}{2x_n}$

Q.9 The solution of the initial boundary value problem

$$\frac{\partial u}{\partial t} = \frac{\partial^2 u}{\partial x^2}, \quad 0 < x < \pi, \quad t > 0, \text{ with boundary and initial conditions}$$

$$\frac{\partial u}{\partial x}(0, t) = 0 = u(\pi, t), \quad t > 0 \quad \text{and} \quad u(x, 0) = f(x), \quad 0 < x < \pi, \text{ is}$$

- (A) $u(x, t) = \sum_{n=0}^{\infty} A_n \exp\left(-\left(\frac{2n+1}{2}\right)^2 t\right) \cos\left(\frac{2n+1}{2} x\right)$, with $A_n = \frac{2}{\pi} \int_0^{\pi} f(x) \cos\left(\frac{2n+1}{2} x\right) dx$
(B) $u(x, t) = \sum_{n=0}^{\infty} A_n \exp(-n^2 t) \cos(nx)$, with $A_n = \frac{2}{\pi} \int_0^{\pi} f(x) \cos(nx) dx$
(C) $u(x, t) = \sum_{n=1}^{\infty} A_n \exp\left(-\left(\frac{2n+1}{2}\right)^2 t\right) \sin\left(\frac{2n+1}{2} x\right)$, with $A_n = \frac{2}{\pi} \int_0^{\pi} f(x) \sin\left(\frac{2n+1}{2} x\right) dx$
(D) $u(x, t) = \sum_{n=1}^{\infty} A_n \exp(-n^2 t) \sin(nx)$, with $A_n = \frac{2}{\pi} \int_0^{\pi} f(x) \sin(nx) dx$

Q.10 The function $f(x)$ defined by

$$f(x) = \begin{cases} 3 - x^2, & x \leq 1, \\ 3 - x, & 1 < x \leq 2, \\ x - 1, & x > 2, \end{cases}$$

has

- (A) a local maxima at $x = 3$ and a local minima at $x = 0$
(B) a local maxima at $x = 0$ and no local minima
(C) a local maxima at $x = 0$ and a local minima at $x = 2$
(D) no local maxima and a local minima at $x = 1$

Q.11 In a biased die experiment, the random variable x of the outcome has the (cumulative) distribution function $F(x)$ as shown below.

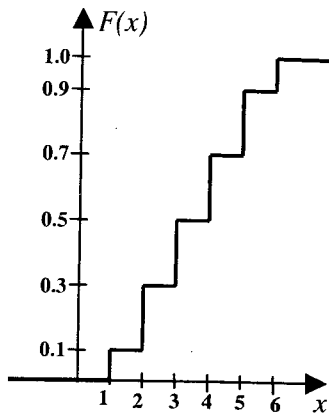

The variance of x is

- (A) 1.5 (B) 2.25 (C) 3.5 (D) 4.25

END OF SECTION - A

B : FLUID MECHANICS

Q. 1 – Q. 9 carry one mark each.

- Q.1 For a boundary layer on a flat plate _____ forces and _____ forces are of the same order of magnitude.
- (A) body, inertia (B) viscous, body
(C) inertia, viscous (D) viscous, pressure
- Q.2 The temperature field in a fluid flow is given by $(60 - 0.2xy) ^\circ\text{C}$. The velocity field is $\vec{V} = 2xy\hat{i} + ty\hat{j}$ m/s. The rate of change of the temperature measured by a thermometer moving along with the flow at $(2, -4)$ m at $t = 4$ s is
- (A) $-12.8 ^\circ\text{C/s}$ (B) $-10.6 ^\circ\text{C/s}$ (C) $-6.4 ^\circ\text{C/s}$ (D) $-4.8 ^\circ\text{C/s}$
- Q.3 Two tanks, A and B, with the same height are filled with water till the top. The volume of tank A is 10 times the volume of tank B. What can you say about the pressures p_A and p_B at the bottom of the tanks A and B respectively?
- (A) $p_A = 10 p_B$
(B) $p_B = 10 p_A$
(C) $p_A = p_B$
(D) Additional data is required to compare the two pressures.
- Q.4 A velocity field in a plane flow is given by $\vec{V} = 2xy\hat{i} + 3y\hat{j}$ m/s. The vorticity at the point $(2,4)$ m is
- (A) $-4\hat{k}$ rad/s (B) $-3\hat{j}$ rad/s (C) $-2\hat{k}$ rad/s (D) $-3\hat{i}$ rad/s
- Q.5 Separation is said to occur at a wall when _____ at the wall becomes zero.
- (A) internal energy (B) pressure
(C) shear stress (D) density
- Q.6 A certain fluid flow is influenced by density (ρ), angular velocity (ω), dynamic viscosity (μ), and a characteristic length (L). A relevant non-dimensional parameter will be
- (A) $\rho\omega\mu / L^2$ (B) $\rho\omega L^2 / \mu$
(C) $\rho\omega\mu L^2$ (D) $\rho\omega\mu L$
- Q.7 The drags due to potential flow past a cylinder of diameter D cm and a slender airfoil of chord length D cm are compared. Assuming unit depth for both the bodies, which one of the following would be **TRUE**?
- (A) The drag on the cylinder is greater
(B) The drag on the airfoil is greater
(C) Both the drags are equal
(D) Additional data is needed to compare the drags

- Q.8 For a fully developed flow between two parallel flat plates, the velocity gradient at a point is found to be 1000 s^{-1} . If the density of the fluid is 880 kg/m^3 and the kinematic viscosity of the fluid is $7.4 \times 10^{-7} \text{ m}^2/\text{s}$, the shear stress at the same point is approximately
- (A) 0 Pa (B) 1.30 Pa (C) 0.32 Pa (D) 0.65 Pa
- Q.9 An open channel flow is to be simulated in the laboratory. For this purpose, a 1:25 scale model is constructed. If the flow velocity in the prototype is 5 m/s, for dynamic similarity the model should have a flow velocity of
- (A) 5 m/s (B) 1 m/s (C) 125 m/s (D) 25 m/s

Q. 10 - Q. 22 carry two marks each.

- Q.10 A pitot-static probe is inserted in an air flow. A manometer connected to this probe having Hg as the manometric fluid shows a difference of 30 mm. Assume a probe factor of 1. Assuming $\rho_{\text{air}} = 1.23 \text{ kg/m}^3$, $\rho_{\text{Hg}} = 13600 \text{ kg/m}^3$ and $g = 10 \text{ m/s}^2$, the speed of the air flow is approximately
- (A) 66.5 m/s (B) 81.5 m/s (C) 76.5 m/s (D) 92.5 m/s
- Q.11 Consider an L-shaped gate with water level above the hinge as shown. At approximately what height D of the water level will the gate open? Neglect the mass of the gate. Assume $g = 10 \text{ m/s}^2$.

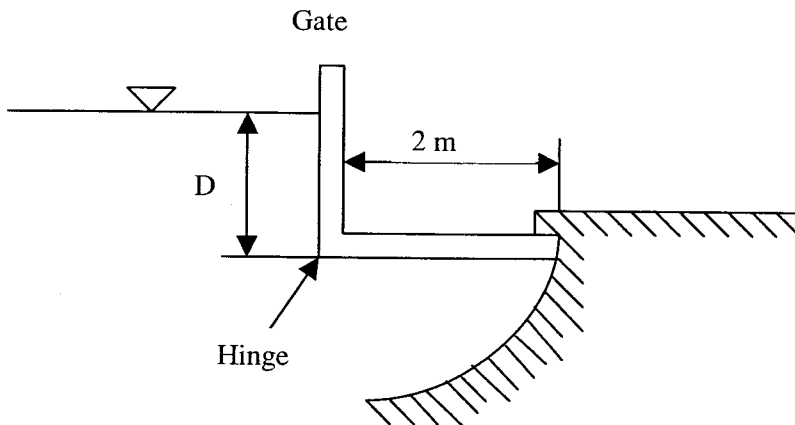

- (A) 3.46 m (B) 4.36 m (C) 6.43 m (D) 5.36 m

- Q.12 When a large tank containing water is placed on a weighing scale, a reading of 10000 N is obtained. The tank is fitted with an outlet pipe and a valve as shown. When the valve is opened, a jet of water with a velocity of 10 m/s issues out in the vertically upward direction. The diameter of the outlet pipe is 10 cm. Determine approximately the reading on the weighing scale at the instant the valve is opened and the water jet issues out. Density of water is 1000 kg/m^3 .

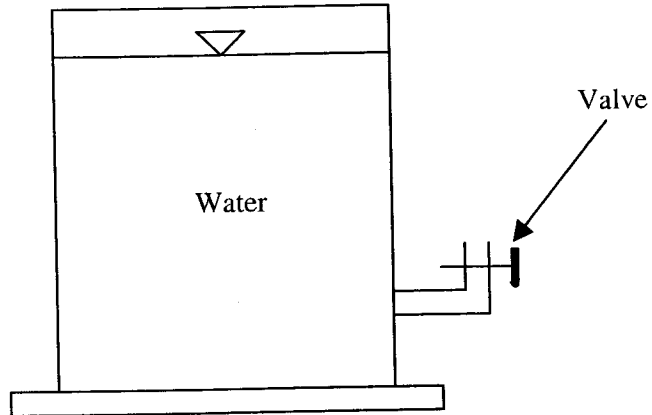

- (A) 9215 N (B) 10000 N (C) 10785 N (D) 12500 N
- Q.13 A fluid with a volumetric flow rate of $5 \text{ m}^3/\text{s}$ enters the nozzle shown below. The cross-sectional area varies with x as $A(x) = 1/(1+x^2)$. Assuming that the flow is parallel and uniform at each cross-section, the acceleration at any point in the nozzle is given by

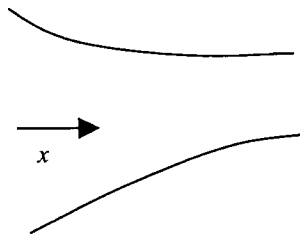

- (A) $50(x+x^3)$ (B) $50(1+x^2)$ (C) 0 (D) $50(x^2+x^3)$
- Q.14 Consider fully developed flow of water in a pipe of diameter 2 cm. The average velocity of the flow is 2 m/s. The viscosity of the water is 10^{-3} kg/m-s and the density is 1000 kg/m^3 . The friction factor can be calculated using $f = 64/\text{Re}$ for laminar flows and $f = 0.3164/\text{Re}^{0.25}$ for turbulent flows. The pressure drop over a length of 0.5 m is
- (A) 0.08 Pa (B) 325 Pa (C) 1115 Pa (D) 9875 Pa

- Q.15 Consider a steady, fully developed flow in a horizontal pipe of diameter D . Over a section of length L of this pipe, a pressure drop of Δp is observed. The average wall shear stress over this section is
- (A) $\frac{\Delta p D}{4L}$ (B) $\frac{\Delta p D}{2L}$ (C) $\frac{\Delta p \pi L}{2D}$ (D) $\frac{\Delta p \pi L}{4D}$
- Q.16 In an inviscid incompressible flow, the velocity field is given by $\vec{V} = x\hat{i} + y\hat{j}$ m/s and the body force per unit mass is given by $\vec{g} = -10\hat{k}$ m/s². The pressure at the point (0, 0, 0) is 101 Pa. Assuming that the density of the fluid is 1 kg/m³, the pressure at the point (1, 1, 1) for this flow is
- (A) 100 Pa (B) 105 Pa (C) 95 Pa (D) 90 Pa

Common Data Questions

Common Data for Questions 17 and 18:

A two-dimensional rectangular water jet of velocity 10 m/s and area 5 cm² impinges normal to a flat plate and splits symmetrically into two half jets, each of area 2.5 cm² as shown. Assume steady flow and neglect viscous effects and the weight of the plate and the water. Density of water is 1000 kg/m³.

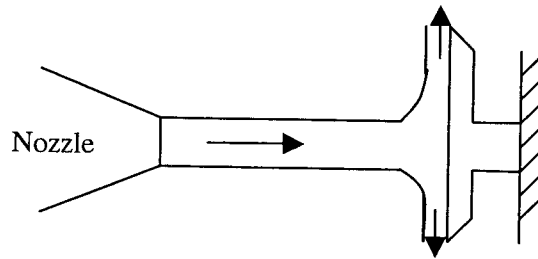

- Q.17 After splitting, the velocity of the upward half-jet along the plate is
- (A) 5 m/s (B) 7.5 m/s (C) 2.5 m/s (D) 10 m/s
- Q.18 The magnitude of the reaction force at the wall is
- (A) 20 N (B) 25 N (C) 35 N (D) 50 N

Common Data for Questions 19 and 20:

A flow has a velocity field given by $\vec{V} = 2x\hat{i} - 2y\hat{j}$

Q.19 The velocity potential $\phi(x, y)$ for the flow is

- (A) $2x - 2y + \text{const.}$ (B) $2xy + \text{const.}$ (C) $x^2 + y^2 + \text{const.}$ (D) $x^2 - y^2 + \text{const.}$

Q.20 The streamlines for the velocity field look like

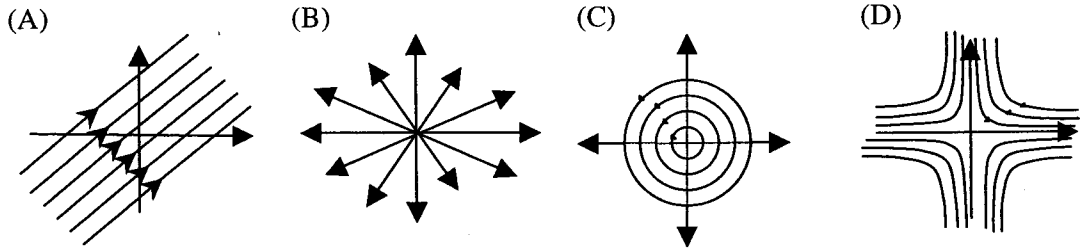
**Linked Answer Questions****Statement for Linked Answer Questions 21 and 22:**

Two flat parallel plates are separated by a small gap h filled with an incompressible fluid of viscosity μ . Assume that the length and width of the plates to be much larger than the gap h . The top plate moves horizontally while the bottom plate is held stationary. The magnitude of the difference between the shear stress at the top and bottom walls is found to be $\Delta\tau$.

Q.21 The velocity of the top plate is

- (A) $h\Delta\tau/(2\mu)$ (B) $h\Delta\tau/\mu$ (C) $2h\Delta\tau/\mu$ (D) $3h\Delta\tau/(2\mu)$

Q.22 If a finite width slender object is introduced parallel to the plates in the middle of the gap, the time at which it would have rotated clockwise by 90° would be

- (A) $2\pi\mu/(\Delta\tau)$ (B) $\pi\mu/(\Delta\tau)$ (C) $2\pi\mu/(3\Delta\tau)$ (D) $\pi\mu/(4\Delta\tau)$

END OF SECTION - B

C : MATERIAL SCIENCE**Useful Data**

Boltzmann's constant	:	$1.38 \times 10^{-23} \text{ J K}^{-1}$
Electron charge	:	$1.602 \times 10^{-19} \text{ C}$
Gas constant	:	$8.314 \text{ J mol}^{-1} \text{ K}^{-1}$

$$1 \text{ J} = 6.242 \times 10^{18} \text{ eV}$$

Atomic weight (kg mol^{-1})

Hydrogen 0.0010

Carbon 0.0120

Chlorine 0.0355

Q.1 – Q.9 carry one mark each.

- Q.1 Which one of the following pairs of crystal structures can have the same packing fraction of 0.74?
 (A) FCC and BCC (B) HCP and BCC (C) FCC and HCP (D) BCC and BCT
- Q.2 Which one of the following is **NOT CORRECT**?
 (A) An edge dislocation can cross slip (B) An edge dislocation can glide
 (C) A screw dislocation can cross slip (D) An edge dislocation can climb
- Q.3 Which one of the following is **NOT CORRECT**?
 (A) Working of lead at 25°C is hot working (B) Working of tungsten at 1000°C is hot working
 (C) Working of lead at -100°C is cold working (D) Working of tungsten at 25°C is cold working
- Q.4 Which one of the following is **NOT** a ceramic?
 (A) SiC (B) MgO (C) TiB_2 (D) TiAl
- Q.5 If the average degree of polymerisation of a polyvinyl chloride (PVC) polymer is 2000, then its average molecular weight (in g mol^{-1}) is
 (A) 125000 (B) 119000 (C) 56000 (D) 2000
- Q.6 Which one of the following materials has the lowest coefficient of thermal expansion?
 (A) Superalloy (B) Super Invar (C) Spinel (D) α -brass
- Q.7 The colour of a metal is determined by the wavelength distribution of the radiation that is
 (A) diffracted (B) transmitted (C) reflected (D) refracted
- Q.8 Nickel ferrite is
 (A) antiferromagnetic (B) ferromagnetic (C) diamagnetic (D) ferrimagnetic
- Q.9 The oxide scale responsible for the excellent corrosion resistance of stainless steels is
 (A) Cr_2O_3 (B) NiO (C) Fe_2O_3 (D) Al_2O_3

Q.10 - Q.22 carry two marks each.

- Q.10 A plain carbon steel was annealed just above the eutectoid temperature. Microstructural analysis revealed that the proeutectoid ferrite content was 30 wt%. The eutectoid reaction in the iron-iron carbide phase diagram is given below:

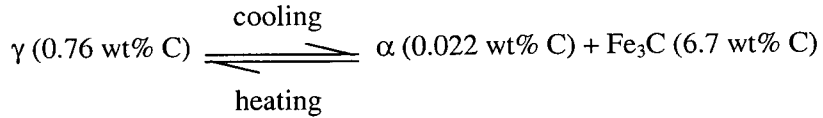

The carbon content of the steel (in wt%) is

- (A) 0.24 (B) 0.34 (C) 0.44 (D) 0.54
- Q.11 Match the materials in **Column-I** with the descriptions in **Column-II**.

Column-I

- P. Zirconia
Q. Cubic boron nitride
R. Hafnium carbide
S. Yttrium aluminium garnet

Column-II

1. Ultra-hard material
2. High temperature superconductor
3. Transformation toughening
4. Ultra-high temperature material
5. Host material for laser
6. Micro-crack toughening

- (A) P-3, Q-4, R-1, S-2
(C) P-3, Q-1, R-4, S-5

- (B) P-6, Q-1, R-4, S-2
(D) P-4, Q-6, R-1, S-5

- Q.12 Match the materials in **Column-I** with the descriptions in **Column-II**.

Column-I

- P. Polyacrylonitrile
Q. Nylon-6,6
R. Polytetrafluoroethylene (PTFE)
S. Ebonite

Column-II

1. Hard and brittle material
2. Very high temperature resistant polymer
3. H-bonding
4. Acrylic fibre
5. Rubber
6. Polyester fibre

- (A) P-6, Q-3, R-2, S-1
(C) P-4, Q-2, R-6, S-5

- (B) P-2, Q-6, R-4, S-5
(D) P-4, Q-3, R-2, S-1

- Q.13 Match the techniques in **Column-I** with the descriptions in **Column-II**.

Column-I

- P. Differential scanning calorimetry
Q. Atomic force microscopy
R. Scanning electron microscopy
S. X-ray diffraction

Column-II

1. Residual stress measurement
2. Surface morphology of a material
3. Incident beam passes through a thin sample
4. Thermal expansion measurement
5. Resolution less than 1 nm is possible
6. Measurement of enthalpy change

- (A) P-6, Q-5, R-2, S-1
(C) P-4, Q-1, R-3, S-2

- (B) P-4, Q-5, R-2, S-1
(D) P-6, Q-1, R-5, S-3

Q.14 Match the properties in **Column-I** with the appropriate units in **Column-II**.

Column-I

- P. Thermal conductivity
 Q. Dielectric strength
 R. Magnetic permeability
 S. Capacitance

Column-II

1. H m^{-1}
 2. Wb m^{-2}
 3. $\text{W m}^{-1} \text{K}^{-1}$
 4. V m^{-1}
 5. C V^{-1}
 6. $\text{J mol}^{-1} \text{K}^{-1}$

(A) P-6, Q-4, R-2, S-5

(B) P-3, Q-5, R-1, S-4

(C) P-3, Q-4, R-1, S-5

(D) P-6, Q-5, R-1, S-4

Q.15 It takes 4 h for carburising a steel at 900°C . If the same carburising is to be accomplished in 2 h, what should be the temperature? The activation energy of diffusion of carbon in the steel is 151 kJ mol^{-1} .

(A) 850°C (B) 955°C (C) 1015°C (D) 1228°C

Q.16 A steel specimen (12 mm diameter and 60 mm length) undergoes elastic deformation under tension. The deformed specimen experiences a longitudinal strain of 0.001. If the Poisson's ratio is 0.3, the diameter of the deformed specimen (in mm) is

(A) 12.0120

(B) 12.0036

(C) 11.9964

(D) 11.9880

Common Data Questions**Common Data for Questions 17 and 18:**

The first peak in the powder X-ray diffraction pattern of an FCC metal appears at a Bragg angle of 19.2° . The wavelength of Cu-K_α radiation used is 0.154 nm .

Q.17 The lattice parameter of the metal (in nm) is

(A) 0.4505

(B) 0.4055

(C) 0.3505

(D) 0.3055

Q.18 The full width at half maximum (FWHM) of the first peak is 0.35° . Ignoring micro-strain and instrumental broadening, the crystallite size of the sample (in nm) is

(A) 20

(B) 24

(C) 200

(D) 240

Common Data for Questions 19 and 20:

For an intrinsic semiconductor, the mobilities of free electrons and holes are $0.14 \text{ m}^2\text{V}^{-1}\text{s}^{-1}$ and $0.038 \text{ m}^2\text{V}^{-1}\text{s}^{-1}$, respectively. Its bandgap is 1.107 eV and electrical conductivity at 300 K is $3.99 \times 10^{-4} \Omega^{-1}\text{m}^{-1}$.

Q.19 The free electron concentration (in m^{-3}) at 300 K is

(A) 13.99×10^{15} (B) 27.98×10^{15} (C) 13.99×10^{17} (D) 27.98×10^{17}

Q.20 What is the temperature at which the conductivity of the semiconductor is $0.399 \Omega^{-1}\text{m}^{-1}$?

(A) 343 K (B) 443 K (C) 493 K (D) 543 K

Linked Answer Questions**Statement for Linked Answer Questions 21 and 22:**

A continuous and aligned glass fibre reinforced composite has a modulus of elasticity of 150 GPa in the longitudinal direction. The matrix is a polyester resin with a modulus of 4.5 GPa. The glass fibre has a modulus of 340 GPa.

Q.21 The volume fraction of the glass fibres is

- (A) 0.398 (B) 0.434 (C) 0.497 (D) 0.566

Q.22 If the cross-sectional area of the composite is 300 mm^2 , and a stress of 100 MPa is applied in the longitudinal direction, what will be the total load (in kN) carried by the glass fibres?

- (A) 0.5 (B) 5 (C) 20.5 (D) 29.5

END OF SECTION - C

D : SOLID MECHANICS

Q. 1 – Q. 9 carry one mark each.

Q.1 A 10 kg rectangular steel block is placed over a smooth cast iron surface. The coefficient of friction between steel and cast iron is 0.4. Acceleration due to gravity is 10 m/s^2 . If a force of 20 N is applied to the block parallel to the surface, the frictional resistance (in N) offered by the surface to the block is

- (A) 0 (B) 4 (C) 20 (D) 40

Q.2 The stress induced in an unconstrained rod that is heated uniformly depends

- (A) only on the coefficient of expansion
 (B) only on the temperature change
 (C) neither on the coefficient of expansion nor on the temperature change
 (D) both on the coefficient of expansion and on the temperature change

Q.3 The Euler buckling load for a long slender column with fixed-fixed end conditions is 10000 N. If the end conditions are changed to fixed-free, the Euler buckling load (in N) would be

- (A) 625 (B) 1250 (C) 2500 (D) 5000

Q.4 For the beam shown, if the maximum deflection occurs at a distance x from support P, which one of the following is **TRUE**?

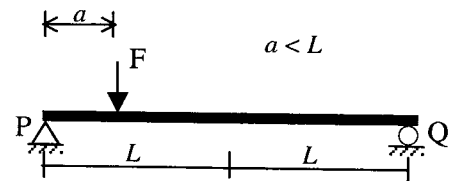

- (A) $0 < x < a$ (B) $x = a$ (C) $a < x < L$ (D) $x = L$

Q.5 For a biaxial state of stress defined by $\sigma_{xx} = 40 \text{ MPa}$, $\sigma_{yy} = -20 \text{ MPa}$, $\tau_{xy} = 30 \text{ MPa}$, the Mohr's circle is centred at (in MPa)

- (A) (0, 10) (B) (0, 30) (C) (10, 0) (D) (60, 0)

Q.6 A mass attached to a string is swung in a circular path with a uniform angular velocity about the horizontal plane, as shown. Seen directly from above, which path would the mass most closely follow if the string breaks suddenly at T?

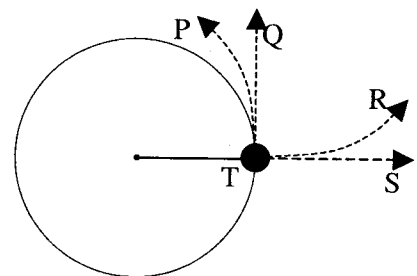

- (A) P (B) Q (C) R (D) S

Q.7 For the beam shown, which of the following are discontinuous at the mid-span?

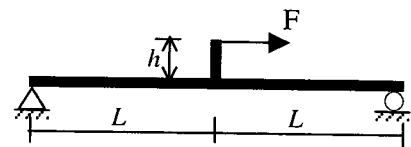

- (A) bending moment only
 (B) axial force and bending moment only
 (C) bending moment and shear force only
 (D) axial force, bending moment and shear force

Q.8 A cylindrical shaft is subjected to pure torsion as shown. At point P, the only stress components expected to be non-zero are

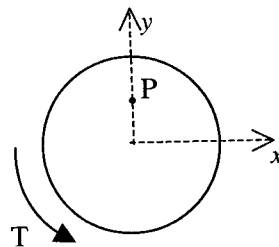

- (A) τ_{yz}, τ_{zy} (B) $\tau_{xy}, \tau_{yx}, \tau_{yz}, \tau_{zy}$ (C) τ_{xy}, τ_{yx} (D) τ_{xz}, τ_{zx}

Q.9 A non-magnetic light rigid frame with two magnets attached to its legs rests on a mild steel plate as shown. A spring, compressed by an amount δ from its unstretched length, connects the steel plate to the center of the frame as shown. Which of the figures below represents the **CORRECT** free-body diagram?

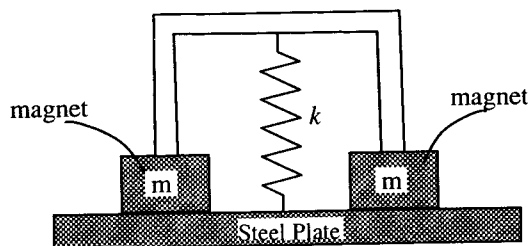

<p>(A)</p>	<p>(B)</p>
<p>(C)</p>	<p>(D)</p>

Q. 10 - Q. 22 carry two marks each.

- Q.10 A cord of negligible mass is wrapped around the outer surface of a 5 kg disk of radius 0.5 m as shown. If the disk is released from rest, the angular velocity of the disk (in rad/s) after 3 seconds is (acceleration due to gravity, $g = 10 \text{ m/s}^2$)

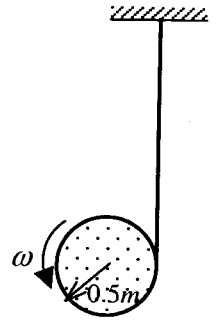

- (A) 30 (B) 40 (C) 60 (D) 120

- Q.11 The force in the member PR for the truss shown is

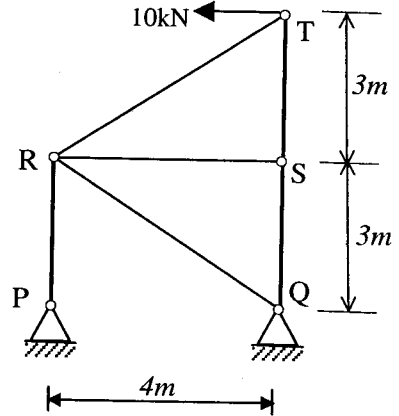

- (A) 12 kN Tensile (B) 12 kN Compressive
(C) 15 kN Tensile (D) 15 kN Compressive

- Q.12 For the configuration shown, the angular velocity (in rad/s) of the rigid rod ST is

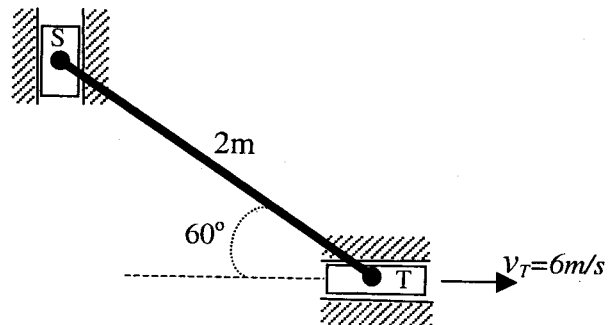

- (A) $\frac{4}{\sqrt{3}}$ (B) 3 (C) $2\sqrt{3}$ (D) 6

- Q.13 If the diameter of a thin hollow homogeneous elastic tube is doubled while retaining the thickness, within the elastic limit, the ratio of the maximum allowable torque to weight would

- (A) remain the same (B) nearly double
(C) become nearly four-fold (D) become nearly eight-fold

- Q.14 A simple mass-spring system shown has a natural frequency of 5 Hz. The static deflection of the spring due to the mass is

(acceleration due to gravity is 9.81 m/s^2 and mass of the spring is negligible)

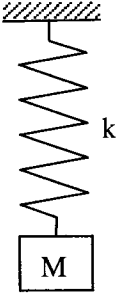

- (A) 0.390 m (B) 0.039 m (C) 0.019 m (D) 0.010 m
- Q.15 An unspecified pure bending moment is used to bend an aluminium rod of radius 2.5 mm elastically into a circular ring of radius 2 m. If the same bending moment is used to bend elastically a copper rod of radius 2 mm, the radius of the resulting ring (in m) is

(elastic modulus of aluminium is 70 GPa and elastic modulus of copper is 120 GPa)

- (A) 0.702 (B) 1.404 (C) 1.755 (D) 2.808
- Q.16 A cylindrical chamber is filled with an elastic material of modulus E , and Poisson's ratio ν , as shown. A piston of diameter $2r$, is pushed down on the elastic material by a force F . Neglecting friction, and assuming that the chamber and the piston are rigid, the piston moves a distance of

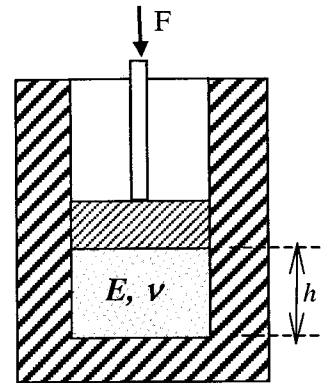

- (A) $\frac{Fh}{\pi r^2 E} \left[1 - \frac{2\nu^2}{1-\nu} \right]$ (B) $\frac{Fh}{\pi r^2 E} \left[1 + \frac{2\nu^2}{1-\nu} \right]$
- (C) $\frac{Fh}{\pi r^2 E} \left[1 - \frac{2\nu^2}{1+\nu} \right]$ (D) $\frac{Fh}{\pi r^2 E} \left[1 + \frac{2\nu^2}{1+\nu} \right]$

Common Data Questions

Common Data for Questions 17 and 18:

A ductile material has tensile yield strength of 200 MPa.

- Q.17 The stress at yield (in MPa) under equi-biaxial compression for this material according to Tresca criterion is

- (A) 200 (B) 100 (C) 80 (D) 50

- Q.18 The stress at yield (in MPa) under pure shear for the same material according to von Mises criterion is

- (A) $\frac{100}{\sqrt{3}}$ (B) $\frac{200}{\sqrt{3}}$ (C) $100\sqrt{2}$ (D) $100\sqrt{3}$

Common Data for Questions 19 and 20:

A hub (outer radius is 35.00 mm and inner radius is 32.98 mm) is press fitted to a shaft (outer radius is 33.00 mm and inner radius is 31.00 mm) over a length of 40.00 mm. The hub and the shaft are made of steel ($E = 200$ GPa, $\nu = 0.3$) and the coefficient of friction is 0.5. The pressure that arises at the interface due to the press fit is given by $p = \frac{Et\delta}{2r^2}$, where r is the nominal radius of the interface, δ is the radial interference and $t = 2$ mm is the nominal thickness. Local stress concentrations can be neglected in the calculations.

- Q.19 The hoop stress (in MPa) developed in the shaft is
 (A) - 60.6 (B) - 30.3 (C) 15.7 (D) 60.6
- Q.20 The maximum torque (in Nm) that can be transmitted by this interference fit is
 (A) 1005.3 (B) 754.0 (C) 601.0 (D) 502.7

Linked Answer Questions**Statement for Linked Answer Questions 21 and 22:**

A 2 kg mass, initially at rest, is acted upon by a time-varying force whose profile is as shown.

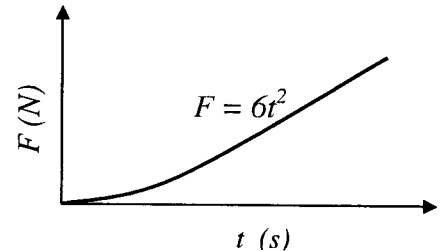

- Q.21 The velocity (in m/s) of the mass is
 (A) t^3 (B) $2t^3$ (C) $6t$ (D) $12t$
- Q.22 The distance travelled by the mass in 2 seconds is
 (A) 24 (B) 12 (C) 8 (D) 4

END OF SECTION - D

E : THERMODYNAMICS

Note : Usual notations have been used for thermodynamic variables.

Useful Data :

Universal gas constant, $R_0 = 8.314 \text{ kJ/kmol.K}$; Acceleration due to gravity, $g = 9.81 \text{ m/s}^2$.

Molecular mass of air, $M_{\text{air}} = 29 \text{ kg/kmol}$; Specific heat at constant pressure of air, $c_p = 1.008 \text{ kJ/kg.K}$;

Ratio of specific heats for air, $\gamma = 1.4$. Assume air to be a perfect gas unless specified otherwise.

Q. 1 – Q. 9 carry one mark each.

Q.1 Identify the group containing the appropriate match of items in **List-I** and **List-II**.

List – I		List – II	
K	A jet engine in flight	P	Closed system
L	Water being heated in a sealed container	Q	Control volume
M	Internal energy	R	Intensive property
N	Specific entropy	S	Extensive property

(A) K-P; L-Q; M-R; N-S

(B) K-Q; L-P; M-R; N-S

(C) K-Q; L-P; M-S; N-R

(D) K-P; L-Q; M-S; N-R

Q.2 The mass, internal energy, pressure, and volume of a system are 10 kg, 100 kJ, 1 bar, and 1 m^3 , respectively. The value of specific enthalpy, in kJ/kg, of the system is

(A) 10

(B) 20

(C) 30

(D) 40

Q.3 A heat pump extracts heat at the rate of 100 kW from a low temperature reservoir and delivers heat at the rate of 160 kW to a high temperature reservoir. The COP of the heat pump is

(A) 1.60

(B) 1.67

(C) 2.60

(D) 2.67

Q.4 At a certain pressure, the specific volumes (m^3/kg) of saturated liquid, saturated vapor, and wet steam are 1.1565×10^{-3} , 0.1274, and 0.1, respectively. The quality of wet steam is

(A) 0.805

(B) 0.783

(C) 0.776

(D) 0.673

Q.5 Which one of the following expressions represents the Joule-Thomson coefficient?

(A) $\left(\frac{\partial T}{\partial p}\right)_h$

(B) $\left(\frac{\partial T}{\partial v}\right)_h$

(C) $\left(\frac{\partial p}{\partial h}\right)_s$

(D) $\left(\frac{\partial s}{\partial T}\right)_p$

Q.6 Specific heat at constant pressure (C_p) of helium is 5.19 kJ/kgK and its molecular mass is 4 kg/kmol. The specific heat at constant volume of helium, in kJ/kgK, is

(A) 1.11

(B) 2.11

(C) 3.11

(D) 4.11

Q.7 An evacuated, rigid, adiabatic tank is filled slowly with air from a supply line supplying air at a constant pressure, p_L and temperature, T_L . The temperature of air in the tank at the end of the filling process will be

(A) greater than T_L

(B) equal to T_L

(C) less than T_L

(D) the average of ambient temperature and T_L

Q.8 An ideal gas undergoes a cyclic process as shown in p-V diagram below :

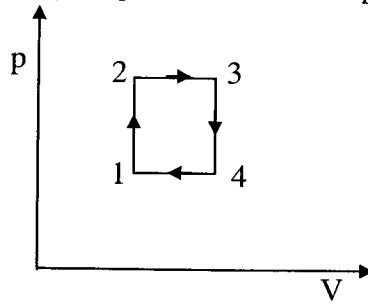

The same cycle, represented in T-S diagram is

(A)

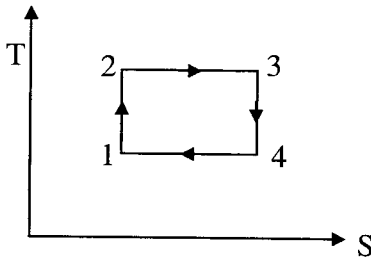

(B)

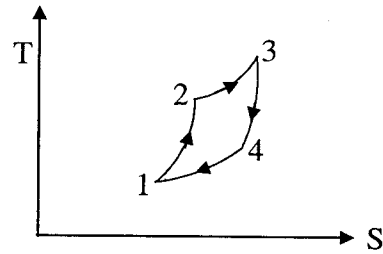

(C)

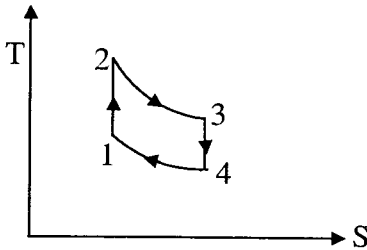

(D)

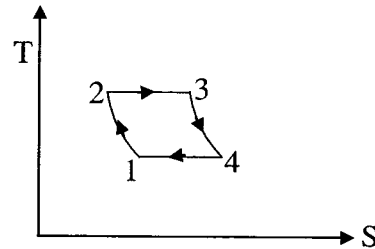

Q.9 Consider three identical tanks A, B and C, shown below. What is the pressure p in tank C?

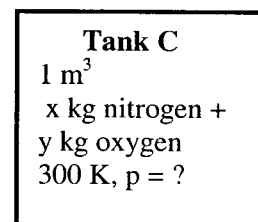
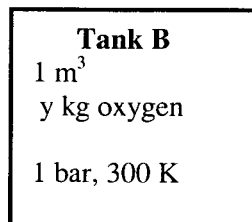
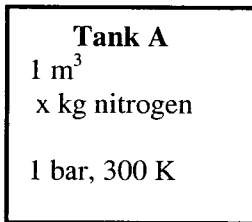

(A) 1 bar

(B) 1.5 bar

(C) 2 bar

(D) 2.5 bar

Q. 10 - Q. 22 carry two marks each.

Q.10 The thermometric property, x , of a thermometer varies with temperature, t , according to the relation $t = ax^2 + b$, where t is in $^{\circ}\text{C}$, x is in cm, and a & b are constants. At ice point (0°C) and steam point (100°C), the values of x are 5 cm and 20 cm, respectively. When this thermometer is brought in contact with a heated body, the value of x is recorded as 15 cm. The temperature of the heated body in $^{\circ}\text{C}$ is

(A) 83.3

(B) 73.3

(C) 63.3

(D) 53.3

Q.11 Air at 10 bar and 400 K is flowing with a velocity of 20 m/s through a pipe of uniform cross-sectional area of 20 cm^2 . The mass flow rate of air in the pipe is approximately

(A) 0.25 kg/s

(B) 0.35 kg/s

(C) 2.5 kg/s

(D) 3.5 kg/s

- Q.12 The condition of steam at inlet and exit of a perfectly insulated steam turbine running under steady-state conditions is as follows:

At inlet: specific enthalpy = 3230 kJ/kg; velocity = 160 m/s

At exit: specific enthalpy = 2660 kJ/kg; velocity = 100 m/s

Neglecting changes in potential energy, the work done by the steam turbine is approximately

- (A) 570 kJ/kg (B) 578 kJ/kg (C) 630 kJ/kg (D) 638 kJ/kg

- Q.13 The thermal efficiency of a reversible heat engine operating between two thermal reservoirs is η_{\max} . The coefficient of performance of a reversible refrigeration cycle operating between the same two reservoirs is

- (A) $\left(\frac{1}{\eta_{\max}}\right) - 1$ (B) $\left(\frac{1}{\eta_{\max}}\right) + 1$ (C) $\left(\frac{1}{\eta_{\max}}\right)$ (D) $1 - \left(\frac{1}{\eta_{\max}}\right)$

- Q.14 Given for water,

at 190°C, saturation pressure = 12.54 bar

at 210°C, saturation pressure = 19.06 bar

at 200°C, specific volume of saturated liquid = $1.1565 \times 10^{-3} \text{ m}^3/\text{kg}$

at 200°C, specific volume of saturated vapor = 0.1274 m^3/kg

Using Clapeyron equation, the enthalpy of vaporization (kJ/kg) of water at 200°C is approximately

- (A) 1857 (B) 1924 (C) 1947 (D) 2025

- Q.15 An ideal vapor compression refrigeration cycle uses R-134a as working fluid. The condenser pressure is 5 bar and evaporator pressure is 60 kPa. The refrigerant enters the compressor as saturated vapor and its specific enthalpy at the compressor exit is 267.98 kJ/kg. The other relevant data regarding R-134a are given below:

Pressure, bar	h_f , kJ/kg	h_g , kJ/kg	s_f , kJ/kg.K	s_g , kJ/kg.K
0.6	3.46	224.72	0.0147	0.9520
5	71.33	256.07	0.2723	0.9117

The COP of the cycle is approximately

- (A) 2.55 (B) 3.55 (C) 4.11 (D) 5.11

- Q.16 One kilomole of hydrogen ($M = 2 \text{ kg/kmol}$) is mixed with certain number of kilomoles of argon ($M = 40 \text{ kg/kmol}$) such that the mass fraction of argon in the resultant mixture is 0.8. The number of kilomoles of argon in the mixture is

- (A) 0.05 (B) 0.10 (C) 0.15 (D) 0.20

Common Data Questions

Common Data for Questions 17 and 18:

A steam power plant operates on an ideal Rankine cycle between pressures of 5 MPa (boiler) and 10 kPa (condenser). Water enters the pump at a specific enthalpy of 191.83 kJ/kg, and specific volume 0.00101 m^3/kg , and steam enters the turbine at an enthalpy of 4612.2 kJ/kg, and leaves the turbine as saturated vapor at 10 kPa. The enthalpy of vaporization of water at 10 kPa is 2392.8 kJ/kg.

- Q.17 The net work done per cycle (kJ/kg) is approximately

- (A) 2023 (B) 2123 (C) 2223 (D) 2323

- Q.18 The thermal efficiency of the cycle is

- (A) 35.8% (B) 40.8% (C) 45.8% (D) 50.8%

Common Data for Questions 19 and 20:

At the beginning of compression process of an air-standard Otto cycle, pressure, temperature, and volume are 1 bar, 290 K, and 400 cm^3 , respectively. The compression ratio is 8. The maximum temperature attained in the cycle is 2200 K.

- Q.19 The heat transferred (kJ) during the heat addition process is approximately
- (A) 531 (B) 53.1 (C) 5.31 (D) 0.531
- Q.20 The thermal efficiency of the cycle is
- (A) 41.5 % (B) 46.5 % (C) 51.5 % (D) 56.5 %

Linked Answer Questions**Statement for Linked Answer Questions 21 and 22:**

An ideal gas undergoes a cyclic process consisting of the following three processes:

Process 1-2: Compression process with $pV = \text{constant}$

Process 2-3: Constant pressure

Process 3-1: Constant volume; $U_3 - U_1 = 3549 \text{ kJ}$

Changes in kinetic and potential energies are neglected.

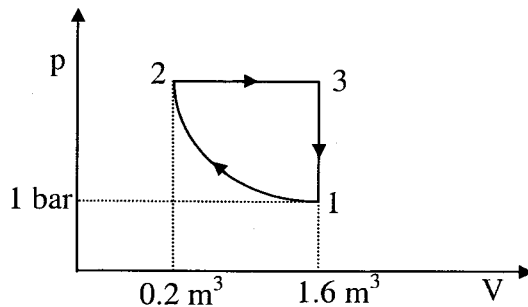

- Q.21 The work done (kJ) during the process 2-3 is
- (A) 1120 (B) 1220 (C) 1320 (D) 1420
- Q.22 The heat transferred (kJ) during the process 2-3 is
- (A) 4269 (B) 4469 (C) 4569 (D) 4669

END OF SECTION - E

F : POLYMER SCIENCE AND ENGINEERING**Q. 1 – Q. 9 carry one mark each.**

- Q.1 Monomers that undergo free radical polymerization have
(A) one hydroxyl and one carboxylic group
(B) double bonds
(C) one amine group and one carboxylic group
(D) two amine groups
- Q.2 In the polymerization of phthalic anhydride (3 moles) and glycerols (3 moles), the average functionality of the reacting system is
(A) 1.2 (B) 4.2 (C) 3.8 (D) 2.5
- Q.3 A mixture consists of 10 moles of dimer, 15 moles of trimer, 20 moles of tetramer and 5 moles of pentamer. The average chain length of the mixture is
(A) 3.4 (B) 8.5 (C) 6.8 (D) 1.7
- Q.4 Polyurethane is formed by
(A) self condensation of polyols (B) self condensation of diisocyanate
(C) reaction of polyol and diisocyanate (D) reaction of polyol with adipic acid
- Q.5 The glass transition temperature (T_g) is governed by
(A) translational motion of entire molecule
(B) long cooperative wriggling motion of 40 to 50 C-C bonds
(C) short cooperative motion of 5 to 6 bonds of the molecules
(D) vibration of carbon atoms of the polymer molecules
- Q.6 The miscibility in binary polymer blends of poly vinyl fluoride and poly acrylate is governed by which one of the following interactions?
(A) dipole-dipole (B) acid-base type
(C) hydrogen bonding (D) ion-dipole
- Q.7 The melting temperature of poly tetrafluoroethylene is higher than its degradation temperature due to
(A) hydrogen bonding (B) π -hydrogen bonding
(C) van der Waal's interaction (D) dipole moment interaction

- Q.8 As the molecular weight (M) increases beyond the critical molecular weight (M_c), the zero shear viscosity of a polymer melt becomes proportional to
 (A) $M^{0.5}$ (B) $M^{3.4}$ (C) $M^{1.0}$ (D) M^0
- Q.9 In the step-growth polymerization of phenol with formaldehyde the functionality of phenol is
 (A) 2 (B) 5 (C) 4 (D) 3

Q. 10 - Q. 22 carry two marks each.

- Q.10 During the processing of polymers, degradation occurs. Pair each item in **Column-I** with the appropriate one in **Column-II**.

Column-I

P. Poly vinyl chloride

Q. Poly acrylonitrile

R. Poly methyl methacrylate

S. Polyethylene

Column-II

1. Elimination of low molecular weight compound

2. Unzipping

3. Cyclization

4. Random scission

- (A) P-1, Q-3, R-2, S-4
 (B) P-1, Q-2, R-3, S-4
 (C) P-2, Q-1, R-3, S-4
 (D) P-4, Q-2, R-3, S-1
- Q.11 The solubility parameter of polystyrene is $9.1 \text{ (cal/cm}^3)^{1/2}$, the solubility parameter of n-hexane is $7.3 \text{ (cal/cm}^3)^{1/2}$ and that of benzene is $9.2 \text{ (cal/cm}^3)^{1/2}$. Then polystyrene will
 (A) dissolve in n-hexane
 (B) not dissolve in 80:20 mixture of n-hexane and benzene
 (C) not dissolve in benzene
 (D) dissolve in benzene
- Q.12 Fiber glass composites are prepared by coating unidirectional fiber glass with epoxy prepolymer. If slippage **DOES NOT** occur at the interface in the loading in the direction of fiber, then
 (A) force sheared by fiber glass (P_f) and matrix (P_m) should be equal
 (B) strain as well force in fiber (ϵ_f and P_f) are both equal to strain and the force in matrix (ϵ_m and P_m)
 (C) strain at the interface between fiber glass (ϵ_f) and matrix (ϵ_m) should be equal
 (D) None of the above is true
- Q.13 The power factor (PF) and dissipative factor (DF) of polymeric materials are related by
 (A) $PF = DF / (1 - DF^2)^{1/2}$ (B) $DF = PF / (1 - PF^2)^{1/2}$
 (C) $DF = 1 / (1 - PF^2)^{1/2}$ (D) $PF = 1 / (1 - DF^2)^{1/2}$
- Q.14 Poly methyl methacrylate (PMMA) and silicone can be used respectively in
 (A) medical syringe and hip joint
 (B) soft tissue replacement and contact lenses
 (C) hip joint and medical syringe
 (D) contact lenses and soft tissue replacement

- Q.15 In the log (viscosity) versus log (shear rate) behaviour of polymer melts, the upper (μ_{upper}) and lower (μ_{lower}) Newtonian viscosities are related as
- (A) μ_{upper} and μ_{lower} versus shear rate are connected by discontinuous curve
 (B) $\mu_{\text{upper}} > \mu_{\text{lower}}$
 (C) $\mu_{\text{upper}} < \mu_{\text{lower}}$
 (D) $\mu_{\text{upper}} = \mu_{\text{lower}}$
- Q.16 Match the following **additives** for plastic with their respective **functions**.

Additives

P. Cetyl Palmitate

Q. Asbestos

R. BaSO₄S. SbO₂**Functions**

1. Fire retardant

2. Heat stabilizer

3. Lubricant

4. Filler

- (A) P-1, Q-2, R-3, S-4
 (B) P-3, Q-4, R-2, S-1
 (C) P-3, Q-2, R-1, S-4
 (D) P-4, Q-3, R-2, S-1

Common Data Questions**Common Data for Questions 17 and 18:**

In a single-screw extruder the dimensions of the channel are:

Diameter (D) = 5.03 cm, Width (W) = 1.1 cm, Height (H) = 0.36 cm, Screw Angle (θ) = 6.3° and Speed of Rotation = 10 revolution per second (rps)

- Q.17 Assume a flat plate model in the melt zone of a single-screw extruder

$$\frac{\partial P}{\partial z} = \eta \frac{\partial^2 v_z}{\partial y^2}; v_z = 0 \text{ at } y = 0 \text{ and } v_z = V_{bz} \text{ at } y = H$$

For fully developed flow in the z direction v_z is found to be

- (A) $v_z = V_{bz} (y/H) - [y (H-y) \partial P / \partial z] / (2\eta)$
 (B) $v_z = (y/H) + [y (H-y) \partial P / \partial z] / (2\eta)$
 (C) $v_z = (y^2/H) + [y (H-y) \partial P / \partial z] / (2\eta)$
 (D) $v_z = (y^2/H) - [y (H-y) \partial P / \partial z] / (2\eta)$
- Q.18 In the absence of a die in a single screw extruder $\Delta P = 0$ and Q is equal to

- (A) 0.31 cm³/sec (B) 3.11 cm³/sec (C) 311 cm³/sec (D) 31.1 cm³/sec

Common Data for Questions 19 and 20:

In the polymerization of styrene at 60°C, it is assumed that all steps are irreversible and
 propagation rate constant (k_p) = 145 lit/mol-sec
 mutual termination rate constant (k_t) = 0.13×10^7 lit/mol-sec
 initiator rate constant (k_I) = 4.38×10^{-6} sec⁻¹
 initiator concentration ($[I_2]$) = 1.65×10^{-2} mol/lit
 monomer concentration ($[M]$) = 7.69 mol/lit

- Q.19 Assuming the rate constant for combination of initiator radical with monomer, $k_1 = 10k_p$ in the polymerization of styrene, the primary radical concentration ($[I\cdot]$) can be calculated as
- (A) $[I\cdot] = 0.364 \times 10^{-8}$ mol/lit
 (B) $[I\cdot] = 1.65 \times 10^{-10}$ mol/lit
 (C) $[I\cdot] = 6.48 \times 10^{-12}$ mol/lit
 (D) $[I\cdot] = 2.74 \times 10^{-4}$ mol/lit
- Q.20 The total molar concentration of the growing polymer radicals (λ_p) in the polymerization of styrene is given by
- (A) $\lambda_p = 4.72 \times 10^{-8}$ mol/lit
 (B) $\lambda_p = 2.36 \times 10^{-7}$ mol/lit
 (C) $\lambda_p = 7.08 \times 10^{-6}$ mol/lit
 (D) $\lambda_p = 9.44 \times 10^{-5}$ mol/lit

Linked Answer Questions**Statement for Linked Answer Questions 21 and 22:**

For semi-crystalline polymeric materials, free of voids and impurities, we define the following:

ρ = average density of a semi-crystalline polymer

ρ_c = density of the crystalline phase

ρ_a = density of the amorphous phase

- Q.21 The relation between the average density and the densities of crystalline and amorphous phases can be related to mass fraction of the crystalline phase (X) as
- (A) $(1/\rho) = (X/\rho_c) + (1/\rho_a)$
 (B) $(1/\rho) = (1/\rho_c) + (1/\rho_a)$
 (C) $(1/\rho) = (1/\rho_c) + \{(1-X)/\rho_a\}$
 (D) $(1/\rho) = (X/\rho_c) + \{(1-X)/\rho_a\}$
- Q.22 When a fiber is made of PET, it has crystalline as well as amorphous phases and experiments have revealed that the average density of the overall material is 1.375 g/cm³. It is known that the density of the crystalline phase is 1.455 g/cm³ and that of amorphous phase is 1.335 g/cm³. The mass fraction crystallinity (X) in % is given by
- (A) 35.3% (B) 50.5% (C) 80.1% (D) 5.1%

END OF SECTION - F

G : FOOD TECHNOLOGY

Q. 1 – Q. 9 carry one mark each.

- Q.1 The protein responsible for spongy structure in bread is
 (A) Albumin (B) Zein (C) Gluten (D) Gliadin
- Q.2 The factor most responsible for making a good ice cream is
 (A) Water content (B) Homogenization
 (C) Emulsifying agent (D) Mixing index
- Q.3 Listed below are some of the functions of fats in the human nutrition. Identify the **INCORRECT** function.
 (A) Concentrated source of energy (B) Transport of oxygen to various organs
 (C) Absorption of fat soluble vitamins (D) Synthesis of cell membranes and hormones
- Q.4 During ripening of cheese by *Penicillium roqueforti* the characteristic aroma is because of
 (A) Methyl ketones (B) Aceto acetic acid
 (C) Diacetyl (D) Acetoin
- Q.5 Which of the following statements is **NOT TRUE** in case of oxidative rancidity of fatty foods?
 (A) Peroxides and hydroperoxides are formed during auto-oxidation
 (B) Auto-oxidation is a complex chain reaction
 (C) The final breakdown products of auto-oxidation are aldehydes, ketones and alcohols
 (D) The reaction is brought about by an enzyme, called lipase
- Q.6 Which of the following group of characteristics is **CORRECT** in respect of *Shigella* species found as food pathogen ?
 (A) Gram positive, motile by gliding, spore forming cocci and transmitted by contaminated food
 (B) Gram negative, motile by flagella, spore forming bacilli and transmitted by contaminated water
 (C) Gram positive, non-motile, non-spore forming cocci and transmitted by contaminated air and water both
 (D) Gram negative, non-motile, non-spore forming and transmitted by fecal-oral route
- Q.7 Relate the vitamins listed below (left hand side) with the associated diseases (right hand side)
- | | |
|-------------------|-------------|
| P. Thiamin | 1. Pellagra |
| Q. Nicotinic acid | 2. Beriberi |
| R. Folic acid | 3. Scurvy |
| S. Ascorbic acid | 4. Anemia |
- (A) P – 1, Q – 2, R – 3, S – 4
 (B) P – 4, Q – 3, R – 2, S – 1
 (C) P – 2, Q – 1, R – 4, S – 3
 (D) P – 3, Q – 4, R – 1, S – 2
- Q.8 Which of the following conditions for the heat resistance of microorganisms is **CORRECT** ?
 (A) Psychrophiles < Mesophiles < Thermophiles
 (B) Psychrophiles > Mesophiles > Thermophiles
 (C) Thermophiles > Psychrophiles > Mesophiles
 (D) Mesophiles < Thermophiles < Psychrophiles

- Q.9 The solubility of sodium bicarbonate in water is 9.6 g/100 g at 20 °C and 16.4 g/100 g at 60 °C. If a saturated solution of sodium bicarbonate at 60 °C is cooled to 20 °C, the percentage of the dissolved salt crystallized out will be
- (A) 20.5 (B) 25.4 (C) 41.5 (D) 45.2

Q. 10 - Q. 22 carry two marks each.

- Q.10 A sugar syrup (density = 1040 kg/m³ and viscosity = 1600 × 10⁻⁶ Pa.s) is required to be pumped in to a tank (1.5 m diameter and 3 m height) by a 3 cm inside diameter pipe. If the liquid is required to flow under laminar flow conditions, the minimum time to fill the tank with the syrup will be
- (A) 192.9 h (B) 19.3 h (C) 38.6 h (D) 57.9 h
- Q.11 Match the following sauerkraut defects for their causative agents
- | | |
|-----------------|--|
| P. Soft kraut | 1. Due to growth of bacteria, mold and/or yeast |
| Q. Slimy kraut | 2. Due to surface growth of <i>Torula</i> yeast |
| R. Rotted kraut | 3. Bacterial growth does not initiate till last stage |
| S. Pink kraut | 4. Rapid growth of <i>Lactobacillus cucumens</i> and <i>L. plantarum</i> specially at elevated temperature |
- (A) P – 4, Q – 2, R – 3, S – 1
 (B) P – 3, Q – 4, R – 1, S – 2
 (C) P – 1, Q – 3, R – 2, S – 4
 (D) P – 2, Q – 1, R – 4, S – 3
- Q.12 Match the following carbohydrates with their use in the food processing
- | | |
|------------------------|---|
| P. High amylose starch | 1. White sauces in cook freeze operations |
| Q. Pectin | 2. Edible film for wrapping candies |
| R. Starch phosphates | 3. As humectant in confectionary |
| S. Glucose | 4. Setting agent in jams and jellies |
- (A) P – 1, Q – 2, R – 4, S – 3
 (B) P – 2, Q – 4, R – 1, S – 3
 (C) P – 3, Q – 1, R – 2, S – 4
 (D) P – 4, Q – 3, R – 1, S – 2
- Q.13 Match the food items and their principal flavouring agents given in the two columns below
- | | |
|-----------|-------------|
| P. Butter | 1. Menthol |
| Q. Orange | 2. Limonene |
| R. Cloves | 3. Eugenol |
| S. Mint | 4. Diacetal |
- (A) P – 3, Q – 2, R – 4, S – 1
 (B) P – 2, Q – 3, R – 1, S – 4
 (C) P – 4, Q – 1, R – 3, S – 2
 (D) P – 4, Q – 2, R – 3, S – 1

- Q.14 Match the food items on left hand side with their colloidal nature on right hand side
- | | |
|----------------------|-------------|
| P. Curd | 1. Foam |
| Q. Butter | 2. Emulsion |
| R. Vegetable soup | 3. Sol |
| S. Whipped egg white | 4. Gel |
- (A) P – 2, Q – 1, R – 3, S – 4
 (B) P – 4, Q – 3, R – 2, S – 1
 (C) P – 4, Q – 2, R – 3, S – 1
 (D) P – 3, Q – 4, R – 1, S – 2
- Q.15 In an actively growing (exponential phase) yeast culture, the cell concentration increased from 10^3 cells per ml to 10^7 cells per ml in 4 h. The doubling time of the yeast is
- (A) 120 minutes (B) 30 minutes (C) 18 minutes (D) 60 minutes
- Q.16 The steps followed in Gram's staining of microorganisms are
- P. Washing with neutral organic solvent
 Q. Counter staining with a contrast dye
 R. Staining with basic dye
 S. Fixing the colour with a suitable mordant
- Identify the **CORRECT** sequence.
- (A) Q → S → R → P
 (B) P → Q → R → S
 (C) Q → P → S → R
 (D) R → S → P → Q

Common Data Questions

Common Data for Question 17 and 18:

A continuous dryer was used to dry 12 kg/min of a blanched vegetable containing 50% moisture (wet weight basis) to give a product containing 10% moisture. As the dryer could handle feed material with moisture content not more than 25%, a part of dried material was recycled and mixed with the fresh feed.

- Q.17 The evaporation rate in the dryer would be
- (A) 2.08 kg/min (B) 5.33 kg/min (C) 3.33 kg/min (D) 2.93 kg/min
- Q.18 The recycle ratio to achieve the drying requirement would be
- (A) 2.00 (B) 1.25 (C) 1.67 (D) 4.16

Common Data for Question 19 and 20:

An enzyme has a K_m of 4.7×10^{-5} M and V_m is 22 micro moles per litre per min. The enzyme reaction is carried out at a substrate concentration of 2×10^{-4} M.

- Q.19 The initial reaction velocity for this enzyme catalyzed reaction will be
- (A) 6.5 micro moles per litre per min (B) 17.8 micro moles per litre per min
(C) 13.0 micro moles per litre per min (D) 8.9 micro moles per litre per min
- Q.20 Addition of a competitive inhibitor ($K_i = 3 \times 10^{-4}$ M) at a concentration of 5×10^{-4} M to the above reaction system will result in the inhibition of enzymatic reaction by
- (A) 24.0% (B) 62.5% (C) 76.0% (D) 57.5%

Linked Answer Questions**Statement for Linked Answer Questions 21 and 22:**

The F – value at 121.1 °C, equivalent to 99.9999 per cent destruction of a strain of *Clostridium botulinum*, is 1.8 min.

(D_o and F_o represent the decimal reduction time and lethality of the destruction process at reference temperature, respectively)

- Q.21 The D_o value of the organism will be
- (A) 10.8 min (B) 0.3 min (C) 6.0 min (D) 0.2 min
- Q.22 The F_o value, based on 12D concept using the D_o value of the above organism and a most likely spore load in the product of 100, will be
- (A) 3.0 min (B) 1.2 min (C) 1.5 min (D) 4.2 min

END OF THE QUESTION PAPER