

Q. 1 – Q. 5 carry one mark each.

Q.1 If I were you, I _____ that laptop. It's much too expensive.

- (A) won't buy (B) shan't buy
(C) wouldn't buy (D) would buy

Q.2 He turned a deaf ear to my request.

What does the underlined phrasal verb mean?

- (A) ignored (B) appreciated (C) twisted (D) returned

Q.3 Choose the most appropriate set of words from the options given below to complete the following sentence.

_____ is a will, _____ is a way.

- (A) Wear, there, their (B) Were, their, there
(C) Where, there, there (D) Where, their, their

Q.4 $(x \% \text{ of } y) + (y \% \text{ of } x)$ is equivalent to _____.

- (A) 2 % of xy (B) 2 % of $(xy/100)$ (C) xy % of 100 (D) 100 % of xy

Q.5 The sum of the digits of a two digit number is 12. If the new number formed by reversing the digits is greater than the original number by 54, find the original number.

- (A) 39 (B) 57 (C) 66 (D) 93

Q. 6 – Q. 10 carry two marks each.

- Q.6 Two finance companies, P and Q, declared fixed annual rates of interest on the amounts invested with them. The rates of interest offered by these companies may differ from year to year. Year-wise annual rates of interest offered by these companies are shown by the line graph provided below.

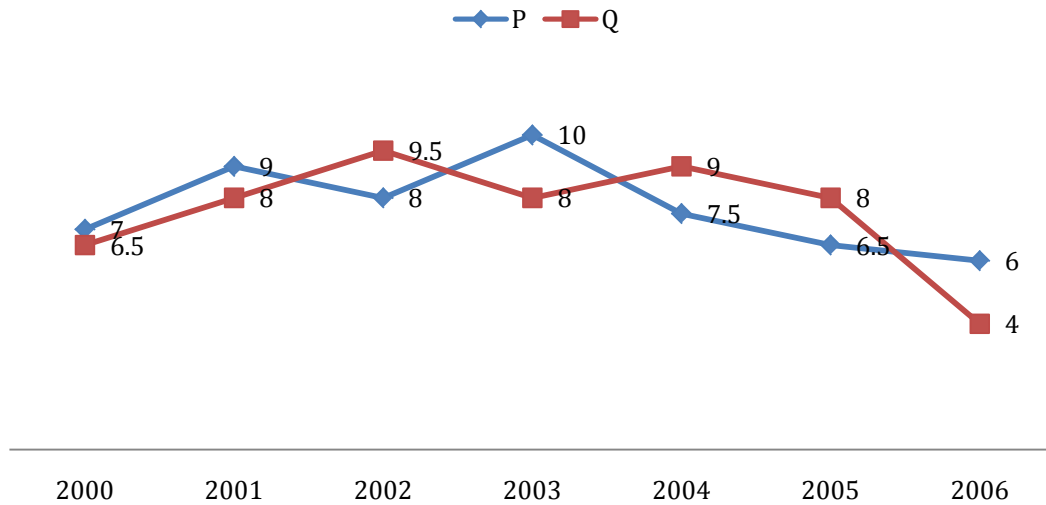

If the amounts invested in the companies, P and Q, in 2006 are in the ratio 8:9, then the amounts received after one year as interests from companies P and Q would be in the ratio:

- (A) 2:3
 - (B) 3:4
 - (C) 6:7
 - (D) 4:3
- Q.7 Today, we consider Ashoka as a great ruler because of the copious evidence he left behind in the form of stone carved edicts. Historians tend to correlate greatness of a king at his time with the availability of evidence today.

Which of the following can be logically inferred from the above sentences?

- (A) Emperors who do not leave significant sculpted evidence are completely forgotten.
- (B) Ashoka produced stone carved edicts to ensure that later historians will respect him.
- (C) Statues of kings are a reminder of their greatness.
- (D) A king's greatness, as we know him today, is interpreted by historians.

- Q.8 Fact 1: Humans are mammals.
Fact 2: Some humans are engineers.
Fact 3: Engineers build houses.

If the above statements are facts, which of the following can be logically inferred?

- I. All mammals build houses.
- II. Engineers are mammals.
- III. Some humans are not engineers.

- (A) II only. (B) III only.
(C) I, II and III. (D) I only.

- Q.9 A square pyramid has a base perimeter x , and the slant height is half of the perimeter. What is the lateral surface area of the pyramid?

- (A) x^2 (B) $0.75x^2$ (C) $0.50x^2$ (D) $0.25x^2$

- Q.10 Ananth takes 6 hours and Bharath takes 4 hours to read a book. Both started reading copies of the book at the same time. After how many hours is the number of pages **to be** read by Ananth, twice that **to be** read by Bharath? Assume Ananth and Bharath read all the pages with constant pace.

- (A) 1 (B) 2 (C) 3 (D) 4

END OF THE QUESTION PAPER

Q. 1 – Q. 25 carry one mark each.

Q.1 The eigenvalues of the matrix

$$\begin{bmatrix} 0 & 1 \\ -1 & 0 \end{bmatrix}$$

are

- (A)
- i
- and
- $-i$
- (B) 1 and
- -1
- (C) 0 and 1 (D) 0 and
- -1

Q.2 The number of solutions of the simultaneous algebraic equations $y = 3x + 3$ and $y = 3x + 5$ is

- (A) zero (B) 1 (C) 2 (D) infinite

Q.3 At $x = 0$, the function

$$f(x) = \left| \sin \frac{2\pi x}{L} \right|, \quad (-\infty < x < \infty, \quad L > 0)$$

is

- (A) continuous and differentiable.
-
- (B) not continuous and not differentiable.
-
- (C) not continuous but differentiable.
-
- (D) continuous but not differentiable.

Q.4 For the two functions

$$f(x, y) = x^3 - 3xy^2 \quad \text{and} \quad g(x, y) = 3x^2y - y^3$$

which one of the following options is correct?

- (A)
- $\frac{\partial f}{\partial x} = \frac{\partial g}{\partial x}$
- (B)
- $\frac{\partial f}{\partial x} = -\frac{\partial g}{\partial y}$
- (C)
- $\frac{\partial f}{\partial y} = -\frac{\partial g}{\partial x}$
- (D)
- $\frac{\partial f}{\partial y} = \frac{\partial g}{\partial x}$

Q.5 The function

$$f(z) = \frac{z^2+1}{z^2+4}$$

is singular at

- (A)
- $z = \pm 2$
- (B)
- $z = \pm 1$
- (C)
- $z = \pm i$
- (D)
- $z = \pm 2i$

Q.6 A fair coin is tossed N times. The probability that head does not turn up in any of the tosses is

- (A)
- $\left(\frac{1}{2}\right)^{N-1}$
- (B)
- $1 - \left(\frac{1}{2}\right)^{N-1}$
- (C)
- $\left(\frac{1}{2}\right)^N$
- (D)
- $1 - \left(\frac{1}{2}\right)^N$

Q.7 A normal random variable X has the following probability density function

$$f_X(x) = \frac{1}{\sqrt{8\pi}} e^{-\left\{\frac{(x-1)^2}{8}\right\}}, \quad -\infty < x < \infty$$

Then $\int_1^{\infty} f_X(x) dx =$

- (A) 0 (B) $\frac{1}{2}$ (C) $1 - \frac{1}{e}$ (D) 1

Q.8 The elastic modulus of a rigid perfectly plastic solid is

- (A) 0 (B) 1 (C) 100 (D) infinity

Q.9 Consider the following statements:

- (P) Hardness is the resistance of a material to indentation.
(Q) Elastic modulus is a measure of ductility.
(R) Deflection depends on stiffness.
(S) The total area under the stress-strain curve is a measure of resilience.

Among the above statements, the correct ones are

- (A) P and Q only. (B) Q and S only. (C) P and R only. (D) R and S only.

Q.10 A beam is subjected to an inclined concentrated load as shown in the figure below. Neglect the weight of the beam.

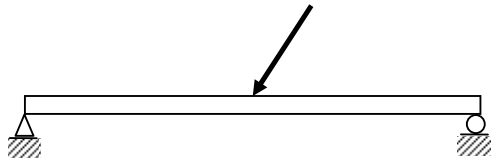

The correct Free Body Diagram of the beam is

(A)

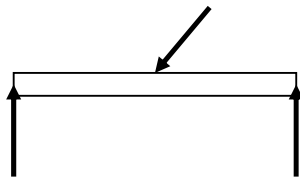

(B)

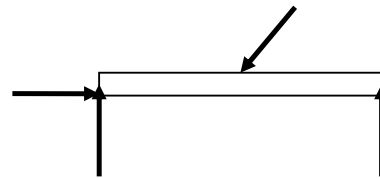

(C)

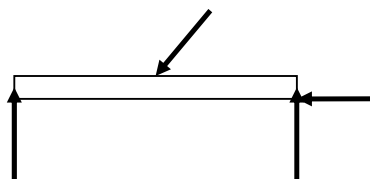

(D)

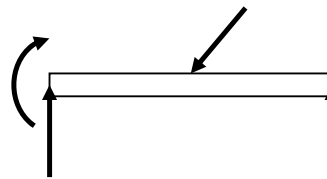

Q.11 Consider a circular cam with a flat face follower as shown in the figure below. The cam is rotated in the plane of the paper about point P lying 5 mm away from its center. The radius of the cam is 20 mm. The distance (in mm) between the highest and the lowest positions of the flat face follower is

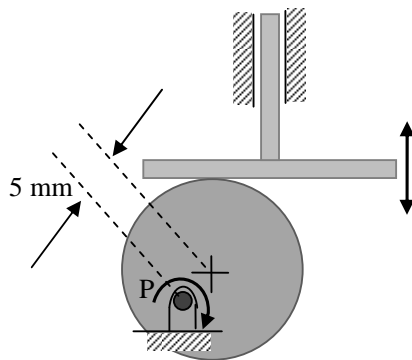

(A) 5

(B) 10

(C) 40

(D) 45

Q.12 A vertical cylindrical tank of 1 m diameter is filled with water up to a height of 5 m from its bottom. Top surface of water is exposed to atmosphere. A hole of 5 mm^2 area forms at the bottom of the tank. Considering the coefficient of discharge of the hole to be unity and the acceleration due to gravity to be 10 m/s^2 , the rate of leakage of water (in litre/min) through the hole from the tank to the atmosphere, under the given conditions, is _____.

Q.13 The figure below shows an air standard Diesel cycle in p - V diagram. The cut-off ratio is given by:

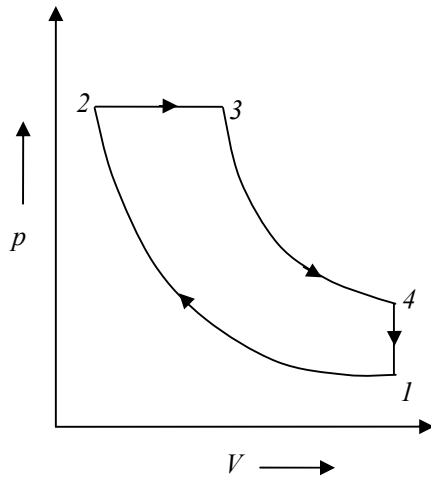

- (A) $\frac{V_3}{V_1}$ (B) $\frac{V_2}{V_1}$ (C) $\frac{V_3}{V_2}$ (D) $\frac{V_1}{V_3}$

Q.14 The ratio of press force required to punch a square hole of 30 mm side in a 1 mm thick aluminium sheet to that needed to punch a square hole of 60 mm side in a 2 mm thick aluminium sheet is _____.

Q.15 Which one of the following is a natural polymer?

- (A) Cellulose (B) Nylon (C) Polyester (D) Polyvinyl chloride

Q.16 In powder metallurgy, sintering of the component

- (A) increases density and reduces ductility.
 (B) increases porosity and reduces density.
 (C) increases density and reduces porosity.
 (D) increases porosity and reduces brittleness.

Q.17 A single point right handed turning tool is used for straight turning. The feed is 0.25 mm/rev and the uncut chip thickness is found to be 0.25 mm . The inclination angle of the main cutting edge is 10° . The back rake angle (in degrees) is _____.

Q.18 Consider the following statements.

- (P) Electrolyte is used in Electro-chemical machining.
- (Q) Electrolyte is used in Electrical discharge machining.
- (R) Abrasive-slurry is used in Ultrasonic machining.
- (S) Abrasive-slurry is used in Abrasive jet machining.

Among the above statements, the correct ones are

- (A) P and R only (B) Q and S only (C) Q, R and S only (D) P and Q only

Q.19 Consider the following statements.

- (P) Computer aided process planning (CAPP) takes input from material requirement plan (MRP).
- (Q) Production flow analysis helps in work cell formation.
- (R) Group technology takes input from choice of machining or cutting parameters.

Among the above statements, the correct one(s) is (are)

- (A) P only (B) Q and R only (C) P and R only (D) Q only

Q.20 The limits of a shaft designated as 100h5 are 100.000 mm and 100.014 mm. Similarly, the limits of a shaft designated as 100h8 are 100.000 mm and 100.055 mm. If a shaft is designated as 100h6, the fundamental deviation (in μm) for the same is

- (A) -22 (B) zero (C) 22 (D) 24

Q.21 The roughness profile of a surface is depicted below.

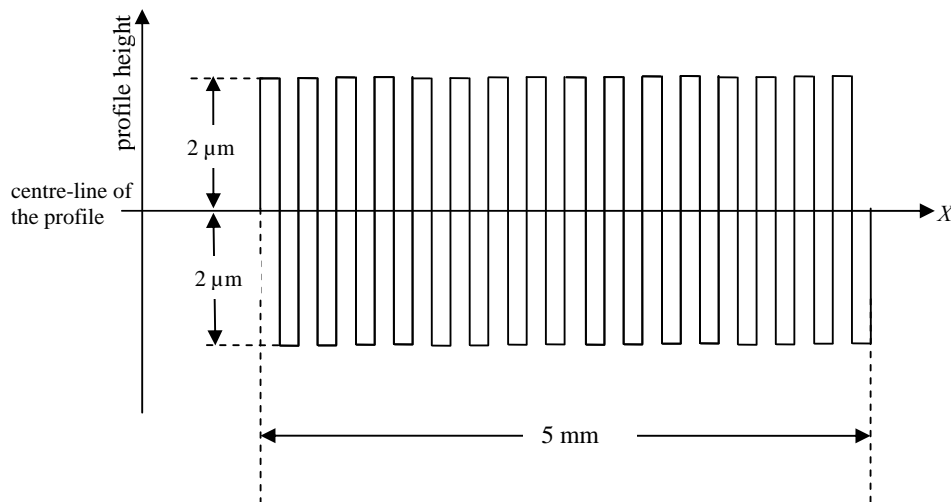

The surface roughness parameter R_a (in μm) is _____.

- Q.22 The facility layout technique that uses relationship (REL) chart is
- (A) CRAFT. (B) Travel chart. (C) Partial Set Covering. (D) ALDEP.
- Q.23 For a random variable, X , let \bar{X} be the sample average. The sample size is n . The mean and the standard deviation of X are μ and σ , respectively. The standard deviation of \bar{X} is
- (A) $n\sigma$ (B) σ (C) $\frac{\sigma}{n}$ (D) $\frac{\sigma}{\sqrt{n}}$
- Q.24 ST and NT denote the standard time and the normal time, respectively, to complete a job. Allowance = $LL \times ST$, where $0 < LL < 1$. Which one of the following relationships is correct?
- (A) $ST = \frac{NT}{(1-LL)}$ (B) $ST = NT(1 + LL)$
(C) $ST = \frac{NT}{(1+LL)}$ (D) $ST = NT(1 - LL)$
- Q.25 The throughput rate of a production system is 20 units per hour. The average flow time is 30 minutes and the cycle time is 3 minutes. The average inventory (in units) in the system is
- (A) 1.5 (B) 9 (C) 10 (D) 11.33

Q. 26 – Q. 55 carry two marks each.

- Q.26 The range of values of k for which the function

$$f(x) = (k^2 - 4)x^2 + 6x^3 + 8x^4$$

has a local maxima at point $x = 0$ is

- (A) $k < -2$ or $k > 2$ (B) $k \leq -2$ or $k \geq 2$
(C) $-2 < k < 2$ (D) $-2 \leq k \leq 2$
- Q.27

$\lim_{x \rightarrow 0} \left(\frac{e^{5x} - 1}{x} \right)^2$ is equal to _____.

Q.28 To solve the equation

$$2 \sin x = x$$

by *Newton-Raphson* method, the initial guess was chosen to be $x = 2.0$. Consider x in radian only. The value of x (in radian) obtained after one iteration will be closest to

- (A) -8.101 (B) 1.901 (C) 2.099 (D) 12.101

Q.29 In linear gas tungsten arc welding of two plates of the same material, the peak temperature T (in K) is given as $T = \frac{C_1 q}{\alpha}$, where q is the heat input per unit length (in J/m) of weld, α is the thermal diffusivity (in m^2/s) of the plate materials and C_1 is a constant independent of process parameters and material types. Two welding cases are given below.

Case I: $V = 15 \text{ V}$, $I = 200 \text{ A}$, $v = 5 \text{ mm/s}$, $k = 150 \text{ W/mK}$, $\rho = 3000 \text{ kg/m}^3$, $C = 900 \text{ J/kg-K}$

Case II: $V = 15 \text{ V}$, $I = 300 \text{ A}$, $v = 10 \text{ mm/s}$, $k = 50 \text{ W/mK}$, $\rho = 8000 \text{ kg/m}^3$, $C = 450 \text{ J/kg-K}$

where, V is welding voltage, I is welding current, v is welding speed, and k , ρ and C refer to the thermal conductivity, the density and the specific heat of the plate materials, respectively. Consider that electrical energy is completely converted to thermal energy. All other conditions remain same.

The ratio of the peak temperature in Case I to that in Case II is

- (A) $\frac{1}{3}$ (B) $\frac{1}{2}$ (C) 1 (D) 2

Q.30 A bar of rectangular cross-sectional area of 50 mm^2 is pulled from both the sides by equal forces of 100 N as shown in the figure below. The shear stress (in MPa) along the plane making an angle 45° with the axis, shown as a dashed line in the figure, is _____.

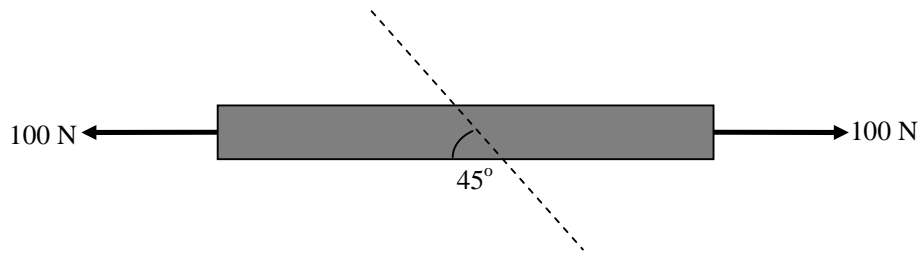

- Q.31 A $1 \text{ m} \times 10 \text{ mm} \times 10 \text{ mm}$ cantilever beam is subjected to a uniformly distributed load per unit length of 100 N/m as shown in the figure below. The normal stress (in MPa) due to bending at point P is _____.

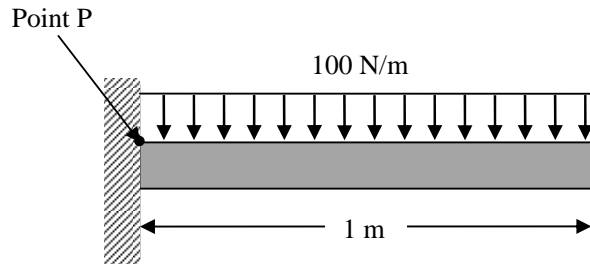

- Q.32 A thin-walled cylindrical pressure vessel of internal diameter 2 m is designed to withstand an internal pressure of 500 kPa (gauge). If the allowable normal stress at any point within the cylindrical portion of the vessel is 100 MPa , the minimum thickness of the plate of the vessel (in mm) is _____.
- Q.33 An engine, connected with a flywheel, is designed to operate at an average angular speed of 800 rpm . During operation of the engine, the maximum change in kinetic energy in a cycle is found to be 6240 J . In order to keep the fluctuation of the angular speed within $\pm 1\%$ of its average value, the moment of inertia (in $\text{kg}\cdot\text{m}^2$) of the flywheel should be _____.
- Q.34 A $2 \text{ m} \times 2 \text{ m}$ square opening in a vertical wall is covered with a metallic plate of the same dimensions as shown in the figure below. Consider the acceleration due to gravity to be 10.0 m/s^2 . The force (in kN) exerted by water on the plate is _____.

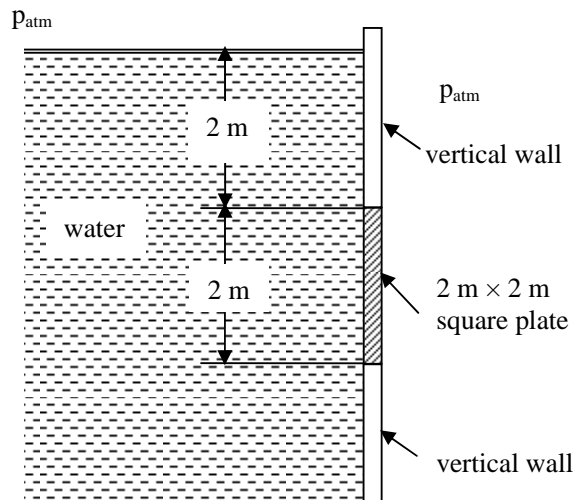

Q.35 An ideal gas of mass m is contained in a rigid tank of volume V at a pressure p . During a reversible process its pressure reduces to p_1 . Following statements are made regarding the process.

- (P) Heat is transferred from the gas.
- (Q) Work done by the gas is zero.
- (R) Entropy of the gas remains constant.
- (S) Entropy of the gas decreases.

Among the above statements, the correct ones are

- (A) P and R only. (B) P, Q and R only. (C) Q and R only. (D) P, Q and S only.

Q.36 A long slender metallic rod of length L is used as a fin. As shown in the figure below, the left end of the fin is kept at a constant temperature t_b . The fin loses heat by convection to the atmosphere which is at a temperature t_a ($t_a < t_b$). Four options of temperature profiles are shown. Identify the correct option.

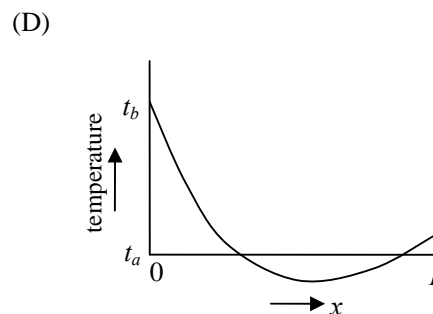
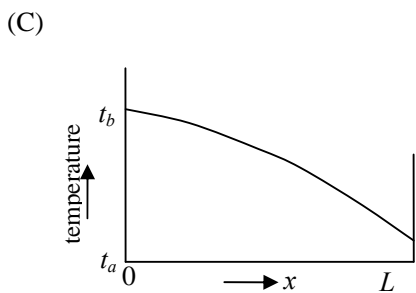
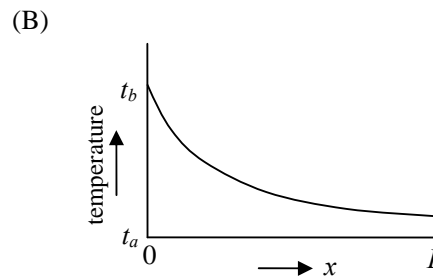
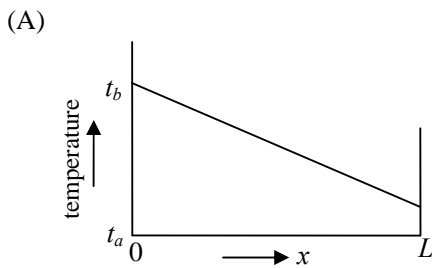
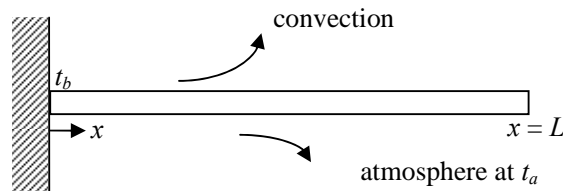

- Q.37 In a fully developed turbulent flow through a circular pipe, a head loss of h_1 is observed. The diameter of the pipe is increased by 10% for the same flow rate and a head loss of h_2 is noted. Assume friction factor for both the cases of pipe flow is the same. The ratio of $\frac{h_2}{h_1}$ is closest to
- (A) 0.34 (B) 0.62 (C) 0.87 (D) 1.00
- Q.38 Two cast iron blocks P and Q, each of 500 mm length, have the same cross-sectional area. Block P has rectangular cross-section of 100 mm \times 200 mm. Block Q is of square cross-section. Both P and Q were cast under the same conditions with all their surfaces enclosed within the mould. The solidification time of a casting is proportional to the square of the ratio of its volume to its surface area. The ratio of solidification time of the block P to that of the block Q is _____.
- Q.39 A 300 mm long copper wire of uniform cross-section is pulled in tension so that a maximum tensile stress of 270 MPa is developed within the wire. The entire deformation of the wire remains linearly elastic. The elastic modulus of copper is 100 GPa. The resultant elongation (in mm) is _____.
- Q.40 In a single-pass rolling operation, a 200 mm wide metallic strip is rolled from a thickness 10 mm to a thickness 6 mm. The roll radius is 100 mm and it rotates at 200 rpm. The roll-strip contact length is a function of roll radius and, initial and final thickness of the strip. If the average flow stress in plane strain of the strip material in the roll gap is 500 MPa, the roll separating force (in kN) is _____.
- Q.41 Two solid cylinders of equal diameter have different heights. They are compressed plastically by a pair of rigid dies to create the same percentage reduction in their respective heights. Consider that the die-workpiece interface friction is negligible. The ratio of the final diameter of the shorter cylinder to that of the longer cylinder is _____.
- Q.42 Two flat steel sheets, each of 2.5 mm thickness, are being resistance spot welded using a current of 6000 A and weld time of 0.2 s. The contact resistance at the interface between the two sheets is 200 $\mu\Omega$ and the specific energy to melt steel is 10×10^9 J/m³. A spherical melt pool of diameter 4 mm is formed at the interface due to the current flow. Consider that electrical energy is completely converted to thermal energy. The ratio of the heat used for melting to the total resistive heat generated is _____.
- Q.43 A cylindrical bar of 100 mm diameter is orthogonally straight turned with cutting velocity, feed and depth of cut of 120 m/min, 0.25 mm/rev and 4 mm, respectively. The specific cutting energy of the work material is 1×10^9 J/m³. Neglect the contribution of feed force towards cutting power. The main or tangential cutting force (in N) is _____.

- Q.44 A 60 mm wide block of low carbon steel is face milled at a cutting speed of 120 m/min, feed of 0.1 mm/tooth and axial depth of cut of 4 mm. A schematic representation of the face milling process is shown below. The diameter of the cutter is 120 mm and it has 12 cutting edges. The material removal rate (in mm^3/s) is _____.

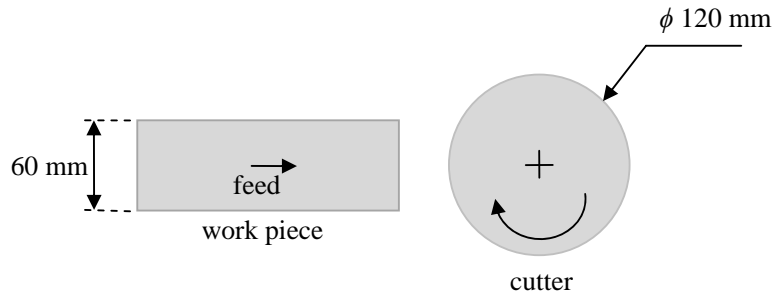

schematic representation (top view)

- Q.45 In abrasive water jet machining, the velocity of water at the exit of the orifice, before mixing with abrasives, is 800 m/s. The mass flow rate of water is 3.4 kg/min. The abrasives are added to the water jet at a rate of 0.6 kg/min with negligible velocity. Assume that at the end of the focusing tube, abrasive particles and water come out with equal velocity. Consider that there is no air in the abrasive water jet. Assuming conservation of momentum, the velocity (in m/s) of the abrasive water jet at the end of the focusing tube is _____.
- Q.46 A single axis CNC table is driven by a DC servo motor that is directly coupled to a lead screw of 5 mm pitch. The circular encoder attached to the lead screw generates 1000 voltage pulses per revolution of the lead screw. The table moves at a constant speed of 6 m/min. The corresponding frequency (in kHz) of the voltage pulses generated by the circular encoder is _____.
- Q.47 A helical gear with involute tooth profile has been machined with a disc-type form gear milling cutter. The helical gear has 30 teeth and a helix angle of 30° . The module of the gear milling cutter is 2. The pitch circle diameter (in mm) of the helical gear is _____.
- Q.48 A quality control engineer has collected 5 samples, each of size 30. The numbers of defective items in the samples are given in the table below.

Sample number	I	II	III	IV	V
Number of defective items	3	2	4	1	5

The upper three-sigma (3σ) control limit for the proportion of defective items in any sample is _____.

- Q.49 A job consists of two work elements, P and Q. Completion time (in minutes) of each work element was measured. A pilot study involved collecting a sample of 40 observations. The results of this pilot study are summarized in the table below.

Work element	Mean completion time (in minutes)	Standard deviation (in minutes)
P	1	0.50
Q	1	0.05

For the main study, the minimum sample size for the sample mean time of any work element to be within 0.1 minutes of its true mean time with 95% confidence (corresponding standard normal value, $z_{0.025} = 1.96$) is _____.

- Q.50 Consider a system with 10 identical components connected in series. The time to failure of each component is exponentially distributed with a failure rate of 0.10 per 500 days. The reliability of the system after 400 days of operation is _____.
- Q.51 For a process, the quality loss coefficient is 5. The target value on the dimension to be attained through the process is 50 mm. If the maximum loss permissible (in monetary terms) is INR 80, the maximum allowable deviation (in mm) from the target is

- (A) $\frac{1}{4}$ (B) $\sqrt{\frac{1}{10}}$ (C) 4 (D) $\sqrt{10}$

- Q.52 Consider a network with nodes 1, 2, 3, 4, 5 and 6. The nodes are connected with directed arcs as shown in the table below. The respective costs (in INR) incurred while traversing the directed arcs are also mentioned.

Directed arcs	1→2	1→3	2→4	2→5	3→2	3→4	3→5	4→5	4→6	5→6
Cost (in INR)	3	9	3	2	2	4	8	7	2	2

The second shortest path from node 1 to node 6 (*i.e.* the path that has the second least total cost and does not use any part of the shortest path) has a total cost (in INR) of

- (A) 7 (B) 8 (C) 15 (D) 19
- Q.53 Five jobs need to be processed on a single machine. All the jobs are available for processing at time $t = 0$. Their respective processing times are given below.

Jobs	I	II	III	IV	V
Processing times (in minutes)	13	4	7	14	11

The average completion time (in minutes) of jobs as per the Shortest Processing Time rule is

- (A) 9.8 (B) 24.2 (C) 49.0 (D) 121.0

- Q.54 Transportation costs (in INR/unit) from factories to respective markets are given in the table below. The market requirements and factory capacities are also given. Using the *North-West Corner* method, the quantity (in units) to be transported from factory R to market II is

		Factory				Requirements (in units)
		P	Q	R	S	
Market	I	3	3	2	1	50
	II	4	2	5	9	20
	III	1	2	1	4	30
Factory Capacity (in units)		20	40	30	10	

- (A) 30 (B) 20 (C) 10 (D) 0

- Q.55 In a given year, a restaurant earned INR 38,500 in revenues. In that year, total expenses incurred were INR 30,000 and the depreciation amount was INR 3,200. At 40% tax rate, the net cash flow (in INR) for that year was _____.

END OF THE QUESTION PAPER

Q. No	Type	Section	Key	Marks
1	MCQ	GA	C	1
2	MCQ	GA	A	1
3	MCQ	GA	C	1
4	MCQ	GA	A	1
5	MCQ	GA	A	1
6	MCQ	GA	D	2
7	MCQ	GA	D	2
8	MCQ	GA	B	2
9	MCQ	GA	D	2
10	MCQ	GA	C	2
1	MCQ	PI	A	1
2	MCQ	PI	A	1
3	MCQ	PI	D	1
4	MCQ	PI	C	1
5	MCQ	PI	D	1
6	MCQ	PI	C	1
7	MCQ	PI	B	1
8	MCQ	PI	D	1
9	MCQ	PI	C	1
10	MCQ	PI	B	1
11	MCQ	PI	B	1
12	NAT	PI	3.0 : 3.0	1
13	MCQ	PI	C	1
14	NAT	PI	0.24 : 0.26	1
15	MCQ	PI	A	1
16	MCQ	PI	C	1
17	NAT	PI	10.0 : 10.0	1
18	MCQ	PI	A	1
19	MCQ	PI	D	1
20	MCQ	PI	B	1
21	NAT	PI	2.0 : 2.0	1
22	MCQ	PI	D	1
23	MCQ	PI	D	1
24	MCQ	PI	A	1
25	MCQ	PI	C	1
26	MCQ	PI	C	2
27	NAT	PI	25.0 : 25.0	2
28	MCQ	PI	B	2
29	MCQ	PI	A	2
30	NAT	PI	0.9 : 1.1	2
31	NAT	PI	290 : 310	2
32	NAT	PI	4.5 : 5.5	2
33	NAT	PI	43.0 : 46.0	2
34	NAT	PI	120 : 120	2
35	MCQ	PI	D	2
36	MCQ	PI	B	2
37	MCQ	PI	B	2
38	NAT	PI	0.88 : 0.92	2
39	NAT	PI	0.80 : 0.82	2

40	NAT	PI	1990 : 2010	2
41	NAT	PI	1.0 : 1.0	2
42	NAT	PI	0.20 : 0.25	2
43	NAT	PI	990 : 1010	2
44	NAT	PI	1526 : 1530	2
45	NAT	PI	678 : 682	2
46	NAT	PI	19.5 : 20.5	2
47	NAT	PI	69.2 : 69.4	2
48	NAT	PI	0.25 : 0.27	2
49	NAT	PI	96 : 97	2
50	NAT	PI	0.40 : 0.46	2
51	MCQ	PI	C	2
52	MCQ	PI	C	2
53	MCQ	PI	B	2
54	MCQ	PI	C	2
55	NAT	PI	6380 : 6380	2