



GATE 2022 Physics (PH)
GATE 2022 General Aptitude

Q.1 – Q.5 Carry ONE mark each.

Q.1	You should _____ when to say _____.
(A)	no / no
(B)	no / know
(C)	know / know
(D)	know / no

Q.2	<p>Two straight lines pass through the origin $(x_0, y_0) = (0,0)$. One of them passes through the point $(x_1, y_1) = (1,3)$ and the other passes through the point $(x_2, y_2) = (1,2)$.</p> <p>What is the area enclosed between the straight lines in the interval $[0, 1]$ on the x-axis?</p>
(A)	0.5
(B)	1.0
(C)	1.5
(D)	2.0

**GATE 2022 Physics (PH)**

Q.3	If $p : q = 1 : 2$ $q : r = 4 : 3$ $r : s = 4 : 5$ and u is 50% more than s , what is the ratio $p : u$?
(A)	2 : 15
(B)	16 : 15
(C)	1 : 5
(D)	16 : 45



GATE 2022 Physics (PH)

Q.4	<p>Given the statements:</p> <ul style="list-style-type: none">• P is the sister of Q.• Q is the husband of R.• R is the mother of S.• T is the husband of P. <p>Based on the above information, T is _____ of S.</p>
(A)	the grandfather
(B)	an uncle
(C)	the father
(D)	a brother

GATE 2022 Physics (PH)

Q.5

In the following diagram, the point R is the center of the circle. The lines PQ and ZV are tangential to the circle. The relation among the areas of the squares, PXWR, RUVZ and SPQT is

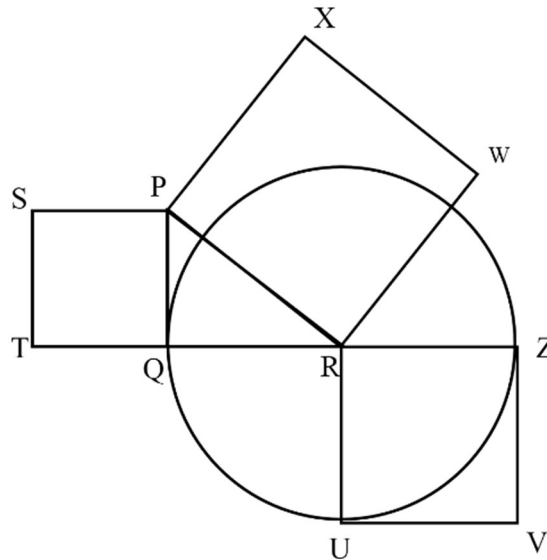

(A) Area of SPQT = Area of RUVZ = Area of PXWR

(B) Area of SPQT = Area of PXWR – Area of RUVZ

(C) Area of PXWR = Area of SPQT – Area of RUVZ

(D) Area of PXWR = Area of RUVZ – Area of SPQT

GATE 2022 Physics (PH)

Q. 6 – Q. 10 Carry TWO marks each.

Q.6	<p>Healthy eating is a critical component of healthy aging. When should one start eating healthy? It turns out that it is never too early. For example, babies who start eating healthy in the first year are more likely to have better overall health as they get older.</p> <p>Which one of the following is the CORRECT logical inference based on the information in the above passage?</p>
(A)	Healthy eating is important for those with good health conditions, but not for others
(B)	Eating healthy can be started at any age, earlier the better
(C)	Eating healthy and better overall health are more correlated at a young age, but not older age
(D)	Healthy eating is more important for adults than kids



GATE 2022 Physics (PH)

Q.7	<p>P invested ₹ 5000 per month for 6 months of a year and Q invested ₹ x per month for 8 months of the year in a partnership business. The profit is shared in proportion to the total investment made in that year.</p> <p>If at the end of that investment year, Q receives $\frac{4}{9}$ of the total profit, what is the value of x (in ₹)?</p>
(A)	2500
(B)	3000
(C)	4687
(D)	8437

GATE 2022 Physics (PH)

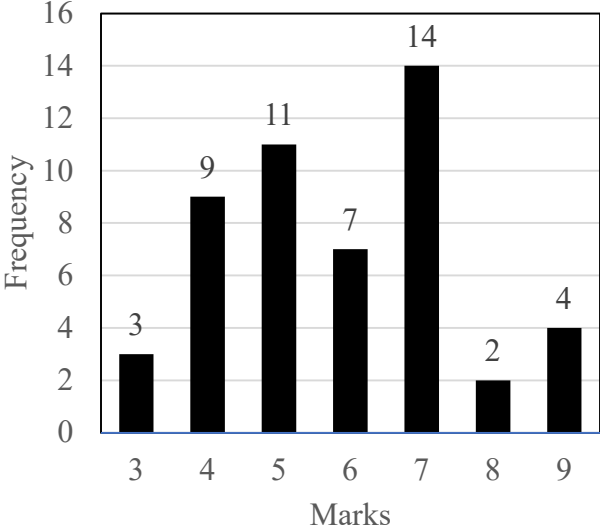
<p>Q.8</p>	<div style="text-align: center;">  <table border="1" style="margin: 10px auto;"> <thead> <tr> <th>Marks</th> <th>Frequency</th> </tr> </thead> <tbody> <tr><td>3</td><td>3</td></tr> <tr><td>4</td><td>9</td></tr> <tr><td>5</td><td>11</td></tr> <tr><td>6</td><td>7</td></tr> <tr><td>7</td><td>14</td></tr> <tr><td>8</td><td>2</td></tr> <tr><td>9</td><td>4</td></tr> </tbody> </table> </div> <p>The above frequency chart shows the frequency distribution of marks obtained by a set of students in an exam.</p> <p>From the data presented above, which one of the following is CORRECT?</p>	Marks	Frequency	3	3	4	9	5	11	6	7	7	14	8	2	9	4
Marks	Frequency																
3	3																
4	9																
5	11																
6	7																
7	14																
8	2																
9	4																
<p>(A) mean > mode > median</p>																	
<p>(B) mode > median > mean</p>																	
<p>(C) mode > mean > median</p>																	
<p>(D) median > mode > mean</p>																	

<p>Q.9</p>	<p>In the square grid shown on the left, a person standing at P2 position is required to move to P5 position.</p>
------------	---

GATE 2022 Physics (PH)

The only movement allowed for a step involves, “two moves along one direction followed by one move in a perpendicular direction”. The permissible directions for movement are shown as dotted arrows in the right.

For example, a person at a given position **Y** can move only to the positions marked **X** on the right.

Without occupying any of the shaded squares at the end of each step, the minimum number of steps required to go from **P2** to **P5** is

	1	2	3	4	5
P		😊			
Q					
R					
S					
T					

Example: Allowed steps for a person at **Y**

(A)	4
(B)	5
(C)	6
(D)	7

GATE 2022 Physics (PH)

Q.10

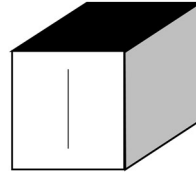

Consider a cube made by folding a single sheet of paper of appropriate shape. The interior faces of the cube are all blank. However, the exterior faces that are not visible in the above view may not be blank.

Which one of the following represents a possible unfolding of the cube?

(A)

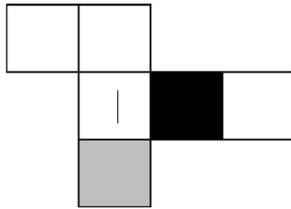

(B)

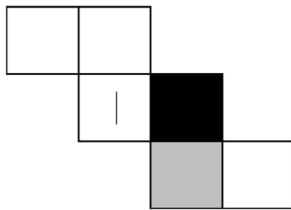

(C)

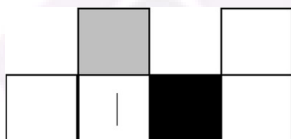

(D)

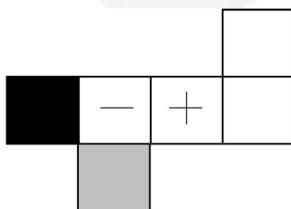

END OF THE QUESTION PAPER

GATE 2022 Physics (PH)

Q.11 – Q.35 Carry ONE mark Each

Q.11

For the Op-Amp circuit shown below, choose the correct output waveform corresponding to the input $V_{in} = 1.5 \sin 20\pi t$ (in Volts). The saturation voltage for this circuit is $V_{sat} = \pm 10$ V.

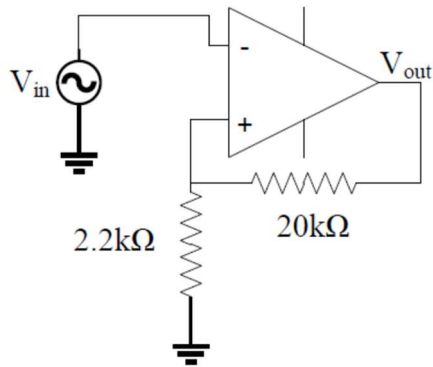

(A)

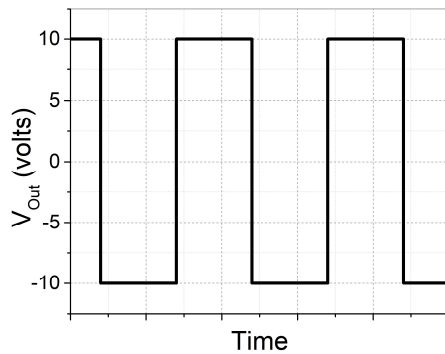

(B)

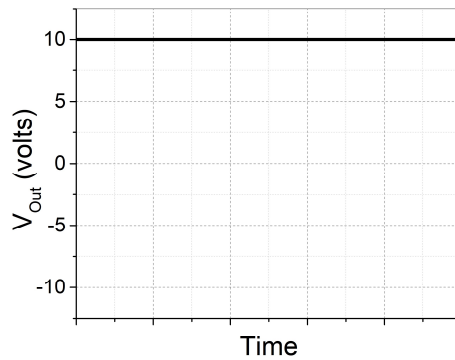

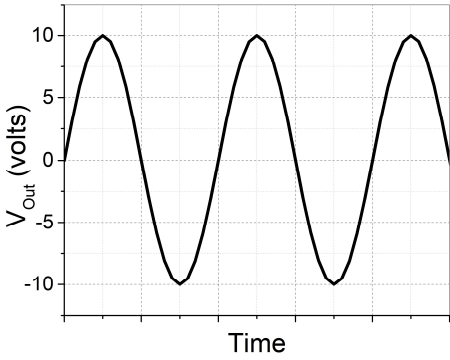
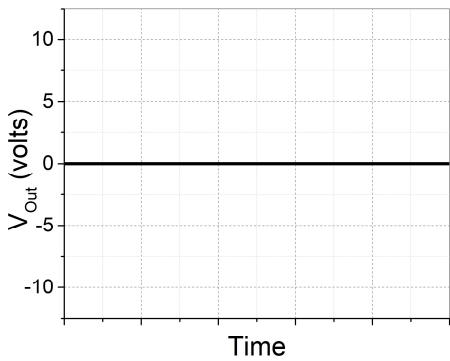

GATE 2022 Physics (PH)

<p>(C)</p>	
<p>(D)</p>	



GATE 2022 Physics (PH)

<p>Q.12</p>	<p>Match the order of β – decays given in the left column to appropriate clause in the right column. Here $X(I^\pi)$ and $Y(I^\pi)$ are nuclei with intrinsic spin I and parity π.</p> <table border="1" data-bbox="320 360 1361 707"> <tr> <td data-bbox="320 360 836 461">1. $X\left(\frac{1}{2}^+\right) \rightarrow Y\left(\frac{1}{2}^+\right)$</td> <td data-bbox="836 360 1361 461">i) First forbidden β-decay</td> </tr> <tr> <td data-bbox="320 461 836 562">2. $X\left(\frac{1}{2}^-\right) \rightarrow Y\left(\frac{5}{2}^+\right)$</td> <td data-bbox="836 461 1361 562">ii) Second forbidden β-decay</td> </tr> <tr> <td data-bbox="320 562 836 633">3. $X(3^+) \rightarrow Y(0^+)$</td> <td data-bbox="836 562 1361 633">iii) Third forbidden β-decay</td> </tr> <tr> <td data-bbox="320 633 836 707">4. $X(4^-) \rightarrow Y(0^+)$</td> <td data-bbox="836 633 1361 707">iv) Allowed β-decay</td> </tr> </table>	1. $X\left(\frac{1}{2}^+\right) \rightarrow Y\left(\frac{1}{2}^+\right)$	i) First forbidden β -decay	2. $X\left(\frac{1}{2}^-\right) \rightarrow Y\left(\frac{5}{2}^+\right)$	ii) Second forbidden β -decay	3. $X(3^+) \rightarrow Y(0^+)$	iii) Third forbidden β -decay	4. $X(4^-) \rightarrow Y(0^+)$	iv) Allowed β -decay
1. $X\left(\frac{1}{2}^+\right) \rightarrow Y\left(\frac{1}{2}^+\right)$	i) First forbidden β -decay								
2. $X\left(\frac{1}{2}^-\right) \rightarrow Y\left(\frac{5}{2}^+\right)$	ii) Second forbidden β -decay								
3. $X(3^+) \rightarrow Y(0^+)$	iii) Third forbidden β -decay								
4. $X(4^-) \rightarrow Y(0^+)$	iv) Allowed β -decay								
(A)	1 – i, 2 – ii, 3 – iii, 4 – iv								
(B)	1 – iv, 2 – i, 3 – ii, 4 – iii								
(C)	1 – i, 2 – iii, 3 – ii, 4 – iv								
(D)	1 – iv, 2 – ii, 3 – iii, 4 – i								
<p>Q.13</p>	<p>What is the maximum number of free independent real parameters specifying an n-dimensional orthogonal matrix?</p>								
(A)	$n(n - 2)$								
(B)	$(n - 1)^2$								
(C)	$\frac{n(n - 1)}{2}$								
(D)	$\frac{n(n + 1)}{2}$								



GATE 2022 Physics (PH)

Q.14	An excited state of Ca atom is $[Mg]3p^54s^23d^1$. The spectroscopic terms corresponding to the total orbital angular momentum are
(A)	S, P, and D
(B)	P, D, and F
(C)	P and D
(D)	S and P
Q.15	On the surface of a spherical shell enclosing a charge free region, the electrostatic potential values are as follows: One quarter of the area has potential ϕ_0 , another quarter has potential $2\phi_0$ and the rest has potential $4\phi_0$. The potential at the centre of the shell is (You can use a property of the solution of Laplace's equation.)
(A)	$\frac{11}{4}\phi_0$
(B)	$\frac{11}{2}\phi_0$
(C)	$\frac{7}{3}\phi_0$
(D)	$\frac{7}{4}\phi_0$



GATE 2022 Physics (PH)

Q.16	A point charge q is performing simple harmonic oscillations of amplitude A at angular frequency ω . Using Larmor's formula, the power radiated by the charge is proportional to
(A)	$q \omega^2 A^2$
(B)	$q \omega^4 A^2$
(C)	$q^2 \omega^2 A^2$
(D)	$q^2 \omega^4 A^2$
Q.17	Which of the following relationship between the internal energy U and the Helmholtz's free energy F is true?
(A)	$U = -T^2 \left[\frac{\partial \left(\frac{F}{T} \right)}{\partial T} \right]_V$
(B)	$U = +T^2 \left[\frac{\partial \left(\frac{F}{T} \right)}{\partial T} \right]_V$
(C)	$U = +T \left[\frac{\partial F}{\partial T} \right]_V$
(D)	$U = -T \left[\frac{\partial F}{\partial T} \right]_V$



GATE 2022 Physics (PH)

Q.18	If nucleons in a nucleus are considered to be confined in a three-dimensional cubical box, then the first four magic numbers are
(A)	2, 8, 20, 28
(B)	2, 8, 16, 24
(C)	2, 8, 14, 20
(D)	2, 10, 16, 28
Q.19	Consider the ordinary differential equation $y'' - 2xy' + 4y = 0$ and its solution $y(x) = a + bx + cx^2$. Then
(A)	$a = 0, c = -2b \neq 0$
(B)	$c = -2a \neq 0, b = 0$
(C)	$b = -2a \neq 0, c = 0$
(D)	$c = 2a \neq 0, b = 0$



GATE 2022 Physics (PH)

Q.20	For an Op-Amp based negative feedback, non-inverting amplifier, which of the following statements are true?
(A)	Closed loop gain < Open loop gain
(B)	Closed loop bandwidth < Open loop bandwidth
(C)	Closed loop input impedance > Open loop input impedance
(D)	Closed loop output impedance < Open loop output impedance
Q.21	From the pairs of operators given below, identify the ones which commute. Here l and j correspond to the orbital angular momentum and the total angular momentum, respectively.
(A)	l^2, j^2
(B)	j^2, j_z
(C)	j^2, l_z
(D)	l_z, j_z



GATE 2022 Physics (PH)

Q.22	For normal Zeeman lines observed \parallel and \perp to the magnetic field applied to an atom, which of the following statements are true?
(A)	Only π -lines are observed \parallel to the field
(B)	σ -lines \perp to the field are plane polarized
(C)	π -lines \perp to the field are plane polarized
(D)	Only σ -lines are observed \parallel to the field
Q.23	Pauli spin matrices satisfy
(A)	$\sigma_\alpha \sigma_\beta - \sigma_\beta \sigma_\alpha = i \epsilon_{\alpha\beta\gamma} \sigma_\gamma$
(B)	$\sigma_\alpha \sigma_\beta - \sigma_\beta \sigma_\alpha = 2i \epsilon_{\alpha\beta\gamma} \sigma_\gamma$
(C)	$\sigma_\alpha \sigma_\beta + \sigma_\beta \sigma_\alpha = \epsilon_{\alpha\beta\gamma} \sigma_\gamma$
(D)	$\sigma_\alpha \sigma_\beta + \sigma_\beta \sigma_\alpha = 2\delta_{\alpha\beta}$



GATE 2022 Physics (PH)

Q.24	For the refractive index $n = n_r(\omega) + in_{im}(\omega)$ of a material, which of the following statements are correct?
(A)	n_r can be obtained from n_{im} and vice versa
(B)	n_{im} could be zero
(C)	n is an analytic function in the upper half of the complex ω plane
(D)	n is independent of ω for some materials
Q.25	Complex function $f(z) = z + z - a ^2$ (a is a real number) is
(A)	continuous at (a, a)
(B)	complex-differentiable at (a, a)
(C)	complex-differentiable at $(a, 0)$
(D)	analytic at $(a, 0)$



GATE 2022 Physics (PH)

Q.26	If $g(k)$ is the Fourier transform of $f(x)$, then which of the following are true?
(A)	$g(-k) = +g^*(k)$ implies $f(x)$ is real
(B)	$g(-k) = -g^*(k)$ implies $f(x)$ is purely imaginary
(C)	$g(-k) = +g^*(k)$ implies $f(x)$ is purely imaginary
(D)	$g(-k) = -g^*(k)$ implies $f(x)$ is real
Q.27	The ordinary differential equation $(1 - x^2)y'' - xy' + 9y = 0$ has a regular singularity at
(A)	-1
(B)	0
(C)	+1
(D)	no finite value of x



GATE 2022 Physics (PH)

Q.28	For a bipolar junction transistor, which of the following statements are true?
(A)	Doping concentration of emitter region is more than that in collector and base region
(B)	Only electrons participate in current conduction
(C)	The current gain β depends on temperature
(D)	Collector current is less than the emitter current
Q.29	Potassium metal has electron concentration of $1.4 \times 10^{28} \text{m}^{-3}$ and the corresponding density of states at Fermi level is $6.2 \times 10^{46} \text{Joule}^{-1} \text{m}^{-3}$. If the Pauli paramagnetic susceptibility of Potassium is $n \times 10^{-k}$ in standard scientific form, then the value of k (an integer) is _____ (Magnetic moment of electron is $9.3 \times 10^{-24} \text{Joule T}^{-1}$; permeability of free space is $4\pi \times 10^{-7} \text{T m A}^{-1}$)
Q.30	A power supply has internal resistance R_S and open load voltage $V_S = 5 \text{ V}$. When a load resistance R_L is connected to the power supply, a voltage drop of $V_L = 4 \text{ V}$ is measured across the load. The value of $\frac{R_L}{R_S}$ is _____ (Round off to the nearest integer)



GATE 2022 Physics (PH)

Q.31	Electric field is measured along the axis of a uniformly charged disc of radius 25 cm. At a distance d from the centre, the field differs by 10% from that of an infinite plane having the same charge density. The value of d is _____ cm. (Round off to one decimal place)
Q.32	In a solid, a Raman line observed at 300 cm^{-1} has intensity of Stokes line four times that of the anti-Stokes line. The temperature of the sample is _____ K. (Round off to the nearest integer) ($1 \text{ cm}^{-1} \equiv 1.44 \text{ K}$)
Q.33	An electromagnetic pulse has a pulse width of 10^{-3} s . The uncertainty in the momentum of the corresponding photon is of the order of $10^{-N} \text{ kg m s}^{-1}$, where N is an integer. The value of N is _____ (speed of light = $3 \times 10^8 \text{ m s}^{-1}$, $h = 6.6 \times 10^{-34} \text{ J s}$)
Q.34	The wavefunction of a particle in a one-dimensional infinite well of size $2a$ at a certain time is $\psi(x) = \frac{1}{\sqrt{6a}} \left[\sqrt{2} \sin\left(\frac{\pi x}{a}\right) + \sqrt{3} \cos\left(\frac{\pi x}{2a}\right) + \cos\left(\frac{3\pi x}{2a}\right) \right]$. Probability of finding the particle in $n = 2$ state at that time is _____ % (Round off to the nearest integer)



GATE 2022 Physics (PH)

Q.35	<p>A spectrometer is used to detect plasma oscillations in a sample. The spectrometer can work in the range of $3 \times 10^{12} \text{ rad s}^{-1}$ to $30 \times 10^{12} \text{ rad s}^{-1}$. The minimum carrier concentration that can be detected by using this spectrometer is $n \times 10^{21} \text{ m}^{-3}$. The value of n is _____ (Round off to two decimal places)</p> <p>(Charge of an electron = $-1.6 \times 10^{-19} \text{ C}$, mass of an electron = $9.1 \times 10^{-31} \text{ kg}$ and $\epsilon_0 = 8.85 \times 10^{-12} \text{ C}^2 \text{ N}^{-1} \text{ m}^{-2}$)</p>

Q.36 – Q.65 Carry TWO marks Each

Q.36	<p>Consider a non-interacting gas of spin 1 particles, each with magnetic moment μ, placed in a weak magnetic field B, such that $\frac{\mu B}{k_B T} \ll 1$. The average magnetic moment of a particle is</p>
(A)	$\frac{2\mu}{3} \left(\frac{\mu B}{k_B T} \right)$
(B)	$\frac{\mu}{2} \left(\frac{\mu B}{k_B T} \right)$
(C)	$\frac{\mu}{3} \left(\frac{\mu B}{k_B T} \right)$
(D)	$\frac{3\mu}{4} \left(\frac{\mu B}{k_B T} \right)$



GATE 2022 Physics (PH)

Q.37	<p>Water at 300 K can be brought to 320 K using one of the following processes.</p> <p>Process 1: Water is brought in equilibrium with a reservoir at 320 K directly.</p> <p>Process 2: Water is first brought in equilibrium with a reservoir at 310 K and then with the reservoir at 320 K.</p> <p>Process 3: Water is first brought in equilibrium with a reservoir at 350 K and then with the reservoir at 320 K.</p> <p>The corresponding changes in the entropy of the universe for these processes are ΔS_1, ΔS_2 and ΔS_3, respectively. Then</p>
(A)	$\Delta S_2 > \Delta S_1 > \Delta S_3$
(B)	$\Delta S_3 > \Delta S_1 > \Delta S_2$
(C)	$\Delta S_3 > \Delta S_2 > \Delta S_1$
(D)	$\Delta S_1 > \Delta S_2 > \Delta S_3$



GATE 2022 Physics (PH)

Q.38	A student sets up Young's double slit experiment with electrons of momentum p incident normally on the slits of width w separated by distance d . In order to observe interference fringes on a screen at a distance D from the slits, which of the following conditions should be satisfied?
(A)	$\frac{\hbar}{p} > \frac{Dw}{d}$
(B)	$\frac{\hbar}{p} > \frac{dw}{D}$
(C)	$\frac{\hbar}{p} > \frac{d^2}{D}$
(D)	$\frac{\hbar}{p} > \frac{d^2}{\sqrt{Dw}}$



GATE 2022 Physics (PH)

Q.39

Consider a particle in three different boxes of width L . The potential inside the boxes vary as shown in figures (i), (ii) and (iii) with $V_0 \ll \frac{\hbar^2 \pi^2}{2mL^2}$. The corresponding ground-state energies of the particle are E_1 , E_2 and E_3 , respectively. Then

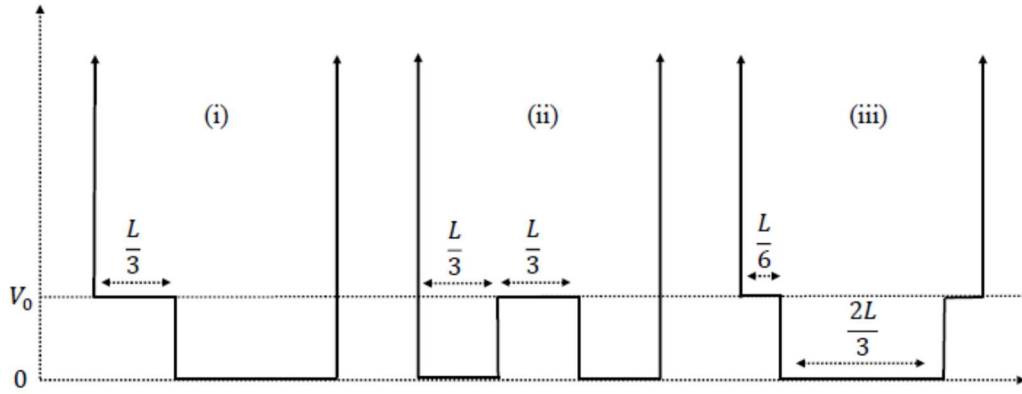

(A)

$$E_2 > E_1 > E_3$$

(B)

$$E_3 > E_1 > E_2$$

(C)

$$E_2 > E_3 > E_1$$

(D)

$$E_3 > E_2 > E_1$$



GATE 2022 Physics (PH)

Q.40	In cylindrical coordinates (s, φ, z) , which of the following is a Hermitian operator?
(A)	$\frac{1}{i} \frac{\partial}{\partial s}$
(B)	$\frac{1}{i} \left(\frac{\partial}{\partial s} + \frac{1}{s} \right)$
(C)	$\frac{1}{i} \left(\frac{\partial}{\partial s} + \frac{1}{2s} \right)$
(D)	$\left(\frac{\partial}{\partial s} + \frac{1}{s} \right)$
Q.41	A particle of mass 1 kg is released from a height of 1 m above the ground. When it reaches the ground, what is the value of Hamilton's action for this motion in J s? (g is the acceleration due to gravity; take gravitation potential to be zero on the ground)
(A)	$-\frac{2}{3} \sqrt{2g}$
(B)	$\frac{5}{3} \sqrt{2g}$
(C)	$3\sqrt{2g}$
(D)	$-\frac{1}{3} \sqrt{2g}$



GATE 2022 Physics (PH)

Q.42	<p>If $(\dot{x} \dot{y} + \alpha xy)$ is a constant of motion of a two-dimensional isotropic harmonic oscillator with Lagrangian</p> $L = \frac{m(\dot{x}^2 + \dot{y}^2)}{2} - \frac{k(x^2 + y^2)}{2}$ <p>then α is</p>
(A)	$+\frac{k}{m}$
(B)	$-\frac{k}{m}$
(C)	$-\frac{2k}{m}$
(D)	0
Q.43	<p>In a two-dimensional square lattice, frequency ω of phonons in the long wavelength limit changes linearly with the wave vector k. Then the density of states of phonons is proportional to</p>
(A)	ω
(B)	ω^2
(C)	$\sqrt{\omega}$
(D)	$\frac{1}{\sqrt{\omega}}$



GATE 2022 Physics (PH)

<p>Q.44</p>	<p>At $T = 0$ K, which of the following diagram represents the occupation probability $P(E)$ of energy states of electrons in a BCS type superconductor?</p>
<p>(A)</p>	
<p>(B)</p>	
<p>(C)</p>	
<p>(D)</p>	



GATE 2022 Physics (PH)

Q.45	For a one-dimensional harmonic oscillator, the creation operator (a^\dagger) acting on the n^{th} state $ \psi_n\rangle$, where $n = 0, 1, 2, \dots$, gives $a^\dagger \psi_n\rangle = \sqrt{n+1} \psi_{n+1}\rangle$. The matrix representation of the position operator $x = \sqrt{\frac{\hbar}{2m\omega}}(a + a^\dagger)$ for the first three rows and columns is
(A)	$\sqrt{\frac{\hbar}{2m\omega}} \begin{pmatrix} 1 & 0 & 0 \\ 0 & \sqrt{2} & 0 \\ 0 & 0 & \sqrt{3} \end{pmatrix}$
(B)	$\sqrt{\frac{\hbar}{2m\omega}} \begin{pmatrix} 0 & 1 & 0 \\ 1 & 0 & 1 \\ 0 & 1 & 0 \end{pmatrix}$
(C)	$\sqrt{\frac{\hbar}{2m\omega}} \begin{pmatrix} 0 & 1 & 0 \\ 1 & 0 & \sqrt{2} \\ 0 & \sqrt{2} & 0 \end{pmatrix}$
(D)	$\sqrt{\frac{\hbar}{2m\omega}} \begin{pmatrix} 1 & 0 & \sqrt{3} \\ 0 & 0 & 0 \\ \sqrt{3} & 0 & 1 \end{pmatrix}$



GATE 2022 Physics (PH)

Q.46	A piston of mass m is fitted to an airtight horizontal cylindrical jar. The cylinder and piston have identical unit area of cross-section. The gas inside the jar has volume V and is held at pressure $P = P_{atmosphere}$. The piston is pushed inside the jar very slowly over a small distance. On releasing, the piston performs an undamped simple harmonic motion of low frequency. Assuming that the gas is ideal and no heat is exchanged with the atmosphere, the frequency of the small oscillations is proportional to
(A)	$\sqrt{\frac{P}{\gamma m V}}$
(B)	$\sqrt{\frac{P \gamma}{V m}}$
(C)	$\sqrt{\frac{P}{m V^{\gamma-1}}}$
(D)	$\sqrt{\frac{\gamma P}{m V^{\gamma-1}}}$



GATE 2022 Physics (PH)

Q.47	A paramagnetic salt of mass m is held at temperature T in a magnetic field H . If S is the entropy of the salt and M is its magnetization, then $dG = -SdT - MdH$, where G is the Gibbs free energy. If the magnetic field is changed adiabatically by $\Delta H \rightarrow 0$ and the corresponding infinitesimal changes in entropy and temperature are ΔS and ΔT , then which of the following statements are correct
(A)	$\Delta S = -\frac{1}{T} \left(\frac{\partial G}{\partial T} \right)_H \Delta T$
(B)	$\Delta S = 0$
(C)	$\Delta T = -\frac{\left(\frac{\partial M}{\partial T} \right)_H}{\left(\frac{\partial S}{\partial T} \right)_H} \Delta H$
(D)	$\Delta T = 0$



GATE 2022 Physics (PH)

Q.48	<p>A particle of mass m is moving inside a hollow spherical shell of radius a so that the potential is</p> $V(r) = \begin{cases} 0 & \text{for } r < a \\ \infty & \text{for } r \geq a \end{cases}$ <p>The ground state energy and wavefunction of the particle are E_0 and $R(r)$, respectively. Then which of the following options are correct?</p>
(A)	$E_0 = \frac{\hbar^2 \pi^2}{2ma^2}$
(B)	$-\frac{\hbar^2}{2m} \frac{1}{r^2} \frac{d}{dr} \left(r^2 \frac{dR}{dr} \right) = E_0 R \quad (r < a)$
(C)	$-\frac{\hbar^2}{2m} \frac{1}{r^2} \frac{d^2 R}{dr^2} = E_0 R \quad (r < a)$
(D)	$R(r) = \frac{1}{r} \sin \left(\frac{\pi r}{a} \right) \quad (r < a)$



GATE 2022 Physics (PH)

Q.49	A particle of unit mass moves in a potential $V(r) = -V_0 e^{-r^2}$. If the angular momentum of the particle is $L = 0.5\sqrt{V_0}$, then which of the following statements are true?
(A)	There are two equilibrium points along the radial coordinate
(B)	There is one stable equilibrium point at r_1 and one unstable equilibrium point at $r_2 > r_1$
(C)	There are two stable equilibrium points along the radial coordinate
(D)	There is only one equilibrium point along the radial coordinate
Q.50	In a diatomic molecule of mass M , electronic, rotational and vibrational energy scales are of magnitude E_e , E_R and E_V , respectively. The spring constant for the vibrational energy is determined by E_e . If the electron mass is m then
(A)	$E_R \sim \frac{m}{M} E_e$
(B)	$E_R \sim \sqrt{\frac{m}{M}} E_e$
(C)	$E_V \sim \sqrt{\frac{m}{M}} E_e$
(D)	$E_V \sim \left(\frac{m}{M}\right)^{1/4} E_e$



GATE 2022 Physics (PH)

Q.51	Electronic specific heat of a solid at temperature T is $C = \gamma T$, where γ is a constant related to the thermal effective mass (m_{eff}) of the electrons. Then which of the following statements are correct?
(A)	$\gamma \propto m_{eff}$
(B)	m_{eff} is greater than free electron mass for all solids
(C)	Temperature dependence of C depends on the dimensionality of the solid
(D)	The linear temperature dependence of C is observed at $T \ll$ Debye temperature
Q.52	In a Hall effect experiment on an intrinsic semiconductor, which of the following statements are correct?
(A)	Hall voltage is always zero
(B)	Hall voltage is negative if the effective mass of holes is larger than those of electrons
(C)	Hall coefficient can be used to estimate the carrier concentration in the semiconductor
(D)	Hall voltage depends on the mobility of the carriers



GATE 2022 Physics (PH)

Q.53	A parallel plate capacitor with spacing d and area of cross-section A is connected to a source of voltage V . If the plates are pulled apart quasistatically to a spacing of $2d$, then which of the following statements are correct?
(A)	The force between the plates at spacing $2d$ is $\frac{1}{8} \left(\frac{\epsilon_0 AV^2}{d^2} \right)$
(B)	The work done in moving the plates is $\frac{1}{8} \left(\frac{\epsilon_0 AV^2}{d} \right)$
(C)	The energy transferred to the voltage source is $\frac{1}{2} \left(\frac{\epsilon_0 AV^2}{d} \right)$
(D)	The energy of the capacitor reduces by $\frac{1}{4} \left(\frac{\epsilon_0 AV^2}{d} \right)$
Q.54	A system with time independent Hamiltonian $H(q, p)$ has two constants of motion $f(q, p)$ and $g(q, p)$. Then which of the following Poisson brackets are always zero?
(A)	$\{H, f + g\}$
(B)	$\{H, \{f, g\}\}$
(C)	$\{H + f, g\}$
(D)	$\{H, H + fg\}$



GATE 2022 Physics (PH)

Q.55

In the action-angle variables $(I_1, I_2, \theta_1, \theta_2)$, consider the Hamiltonian $H = 4I_1I_2$ and $0 \leq \theta_1, \theta_2 < 2\pi$. Let $\frac{I_1}{I_2} = \frac{1}{2}$. Which of the following are possible plots of the trajectories with different initial conditions in θ_1 - θ_2 plane?

(A)

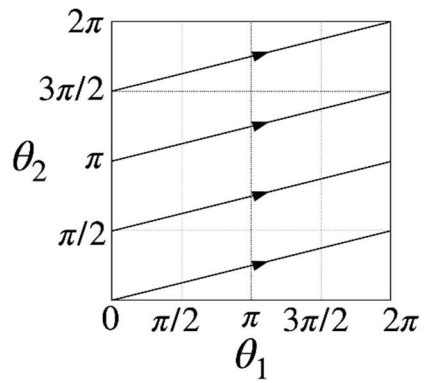

(B)

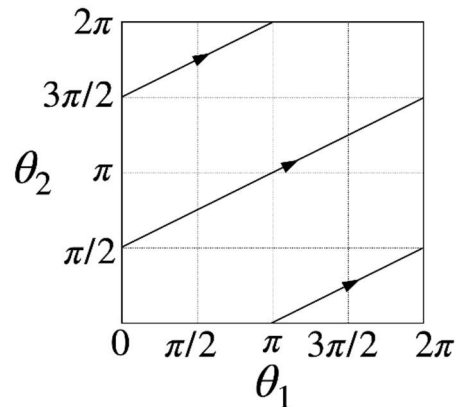

(C)

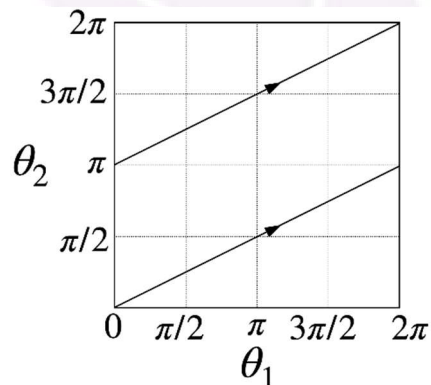

GATE 2022 Physics (PH)

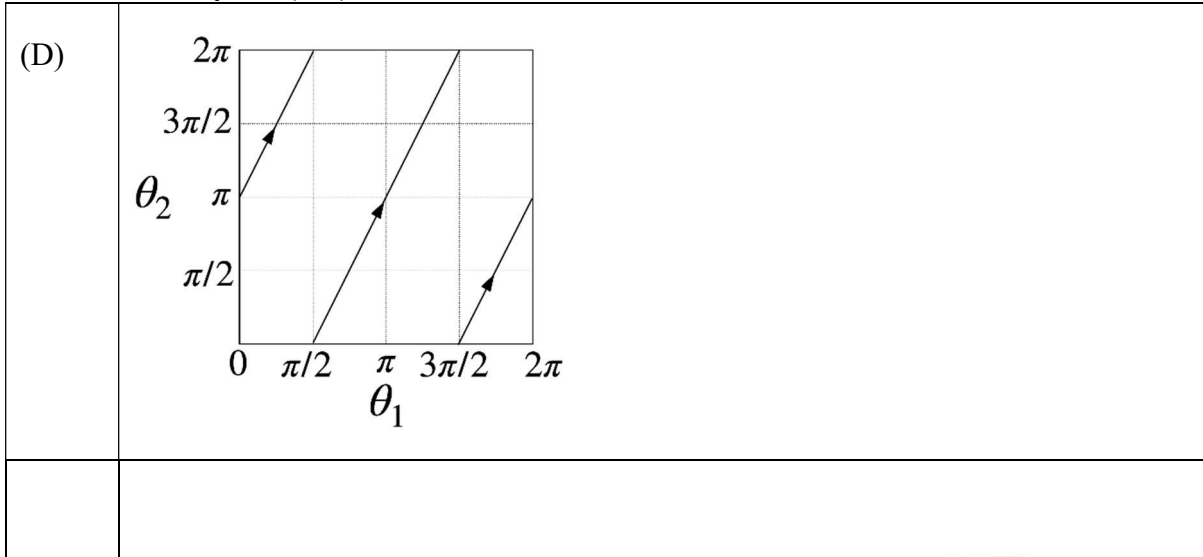



GATE 2022 Physics (PH)

Q.56	A particle of mass m in the x - y plane is confined in an infinite two-dimensional well with vertices at $(0, 0)$, $(0, L)$, (L, L) , $(L, 0)$. The eigenfunctions of this particle are $\psi_{n_x, n_y} = \frac{2}{L} \sin\left(\frac{n_x \pi x}{L}\right) \sin\left(\frac{n_y \pi y}{L}\right)$. If perturbation of the form $V = Cxy$, where C is a real constant, is applied, then which of the following statements are correct for the first excited state?
(A)	The unperturbed energy is $\frac{3\pi^2 \hbar^2}{2mL^2}$
(B)	The unperturbed energy is $\frac{5\pi^2 \hbar^2}{2mL^2}$
(C)	First order energy shift due to the applied perturbation is zero
(D)	The shift (δ) in energy due to the applied perturbation is determined by an equation of the form $\begin{vmatrix} a - \delta & b \\ b & a - \delta \end{vmatrix} = 0$, where a and b are real, non-zero constants

GATE 2022 Physics (PH)

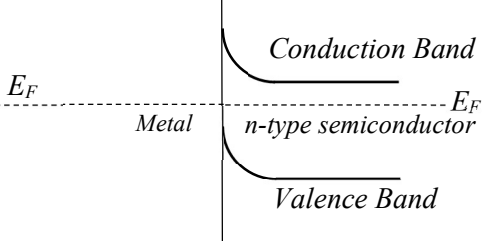
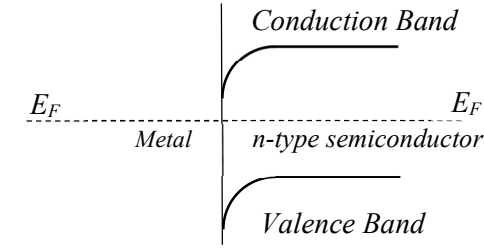
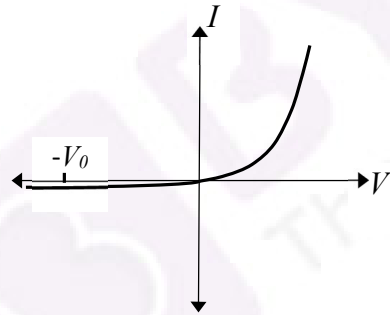
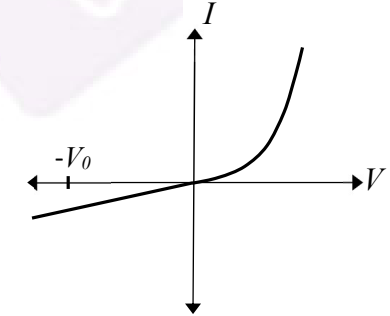
<p>Q.57</p>	<p>A junction is formed between a metal on the left and an n-type semiconductor on the right. Before forming the junction, the Fermi level E_F of the metal lies below that of the semiconductor. Then which of the following schematics are correct for the bands and the I-V characteristics of the junction?</p>
<p>(A)</p>	
<p>(B)</p>	
<p>(C)</p>	
<p>(D)</p>	



GATE 2022 Physics (PH)

Q.58	<p>A plane polarized electromagnetic wave propagating in y-z plane is incident at the interface of two media at Brewster's angle. Taking $z = 0$ as the boundary between the two media, the electric field of the reflected wave is given by</p> $\vec{E}_R = A_R \cos \left[k_0 \left\{ \frac{\sqrt{3}}{2} y - \frac{1}{2} z \right\} - \omega t \right] \hat{x}$ <p>then which among the following statements are correct?</p>
(A)	The angle of refraction is $\frac{\pi}{6}$
(B)	Ratio of permittivity of the medium of refraction (ϵ_2) with respect to the medium on incidence (ϵ_1), $\frac{\epsilon_2}{\epsilon_1} = 3$
(C)	The incident wave can have components of its electric field in y - z plane
(D)	The angle of reflection is $\frac{\pi}{6}$
Q.59	<p>The minimum number of two-input NAND gates required to implement the following Boolean expression is _____</p> $Y = [A\bar{B}(C + BD) + \bar{A}\bar{B}]C$
Q.60	<p>In a nucleus, the interaction $V_{so} \vec{l} \cdot \vec{s}$ is responsible for creating spin-orbit doublets. The energy difference between $p_{1/2}$ and $p_{3/2}$ states in units of $V_{so} \frac{\hbar^2}{2}$ is _____ (Round off to the nearest integer)</p>



GATE 2022 Physics (PH)

Q.61	Two identical particles of rest mass m_0 approach each other with equal and opposite velocity $v = 0.5c$, where c is the speed of light. The total energy of one particle as measured in the rest frame of the other is $E = \alpha m_0 c^2$. The value of α is _____ (Round off to two decimal places)
Q.62	In an X-Ray diffraction experiment on a solid with FCC structure, five diffraction peaks corresponding to (111), (200), (220), (311) and (222) planes are observed using 1.54 \AA X-rays. On using 3 \AA X-rays on the same solid, the number of observed peaks will be _____
Q.63	For 1 mole of Nitrogen gas, the ratio $\left(\frac{\Delta S_I}{\Delta S_{II}}\right)$ of entropy change of the gas in processes (I) and (II) mentioned below is _____ (Round off to one decimal place) (I) The gas is held at 1 atm and is cooled from 300 K to 77 K. (II) The gas is liquified at 77 K. (Take $C_p = 7.0 \text{ cal mol}^{-1} \text{ K}^{-1}$, Latent heat $L = 1293.6 \text{ cal mol}^{-1}$)

GATE 2022 Physics (PH)

<p>Q.64</p>	<p>Frequency bandwidth $\Delta\nu$ of a gas laser of frequency ν Hz is</p> $\Delta\nu = \frac{2\nu}{c} \sqrt{\frac{\alpha}{A}}$ <p>where $\alpha = 3.44 \times 10^6 \text{ m}^2 \text{ s}^{-2}$ at room temperature and A is the atomic mass of the lasing atom. For $^4\text{He} - ^{20}\text{Ne}$ laser (wavelength = 633 nm), $\Delta\nu = n \times 10^9$ Hz. The value of n is _____ (Round off to one decimal place)</p>
<p>Q.65</p>	<p>A current of 1 A is flowing through a very long solenoid made of winding density 3000 turns/m. As shown in the figure, a parallel plate capacitor, with plates oriented parallel to the solenoid axis and carrying surface charge density $6\epsilon_0 \text{ C m}^{-2}$, is placed at the middle of the solenoid. The momentum density of the electromagnetic field at the midpoint X of the capacitor is $n \times 10^{-13} \text{ N s m}^{-3}$. The value of n is _____ (Round off to the nearest integer)</p> <p>(speed of light $c = 3 \times 10^8 \text{ m s}^{-1}$)</p> 