

MATHEMATICS Part-I

STANDARD NINE

$$(a+b)^2 = a^2 + 2ab + b^2$$
$$(a-b)^2 = a^2 - 2ab + b^2$$
$$(a^2 - b^2) = (a+b)(a-b)$$



The Constitution of India

Chapter IV A

Fundamental Duties

ARTICLE 51A

Fundamental Duties- It shall be the duty of every citizen of India—

- (a) to abide by the Constitution and respect its ideals and institutions, the National Flag and the National Anthem;
- (b) to cherish and follow the noble ideals which inspired our national struggle for freedom;
- (c) to uphold and protect the sovereignty, unity and integrity of India;
- (d) to defend the country and render national service when called upon to do so;
- (e) to promote harmony and the spirit of common brotherhood amongst all the people of India transcending religious, linguistic and regional or sectional diversities, to renounce practices derogatory to the dignity of women;
- (f) to value and preserve the rich heritage of our composite culture;
- (g) to protect and improve the natural environment including forests, lakes, rivers and wild life and to have compassion for living creatures;
- (h) to develop the scientific temper, humanism and the spirit of inquiry and reform;
- (i) to safeguard public property and to abjure violence;
- (j) to strive towards excellence in all spheres of individual and collective activity so that the nation constantly rises to higher levels of endeavour and achievement;
- (k) who is a parent or guardian to provide opportunities for education to his child or, as the case may be, ward between the age of six and fourteen years.

The coordination committee formed by GR No. Abhyas - 2116/(Pra.Kra.43/16) SD - 4
Dated 25.4.2016 has given approval to prescribe this textbook in its meeting held on 3.3.2017

MATHEMATICS

Part - I

STANDARD NINE



**Maharashtra State Bureau of Textbook Production and
Curriculum Research, Pune.**



The digital textbook can be obtained through DIKSHA App on a smartphone by using the Q. R. Code given on title page of the textbook and useful audio-visual teaching-learning material of the relevant lesson will be available through the Q. R. Code given in each lesson of this textbook.

**First Edition : 2017
Reprint : 2022**

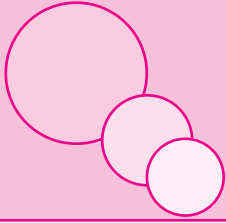

© **Maharashtra State Bureau of Textbook Production and Curriculum Research, Pune - 411 004.**

The Maharashtra State Bureau of Textbook Production and Curriculum Research reserves all rights relating to the book. No part of this book should be reproduced without the written permission of the Director, Maharashtra State Bureau of Textbook Production and Curriculum Research, Pune.

Mathematics Subject Committee

Dr Mangala Naralikar (Chairman)
Dr Jayashri Atre (Member)
Shri. Ramakant Sarode (Member)
Shri. Dadaso Sarade (Member)
Shri Sandeep Panchbhai (Member)
Smt. Lata Tilekar (Member)
Smt. Ujjwala Godbole (Member-Secretary)

Mathematics Study Group (State)

Smt. Pooja Jadhav	Shri. Rama Vanyalkar
Shri. Pramod Thombare	Shri. Ansar Shaikh
Shri. Rajendra Chaudhari	Smt. Suvarna Deshpande
Shri. Annappa Parit	Shri. Ganesh Kolte
Shri Shreepad Deshpande	Shri. Suresh Date
Shri. Bansi Havale	Shri. Prakash Zende
Shri. Umesh Rele	Shri. Shrikant Ratnaparakhi
Shri. Chandan Kulkarni	Shri. Suryakant Shahane
Smt. Anita Jave	Shri. Prakash Kapse
Smt. Bageshri Chavan	Shri. Saleem Hashmi
Shri. Kalyan Kadekar	Smt. Arya Bhide
Shri. Sandesh Sonawane	Shri. Milind Bhakare
Shri. Sujit Shinde	Shri. Dnyaneshwar Mashalkar
Dr Hanumant Jagtap	Shri. Lakshman Davankar
Shri. Pratap Kashid	Shri. Sudhir Patil
Shri. Kashiram Bavisane	Shri. Rajaram Bandgar
Shri. Pappu Gade	Shri. Pradeep Godase
Smt. Rohini Shirke	Shri. Ravindra Khandare
	Shri. Sagar Sakude

Smt. Prajakti Gokhale (Invitee)
Shri. V. D. Godbole (Invitee)
Smt. Taruben Popat (Invitee)

Cover and Illustrations :

Dhanashri Mokashi

Computer Drawings :

Sandeep Koli, Mumbai

Co-ordination : Ujjwala Godbole

I/C Special Officer for Mathematics

Translation : Smt. Prajakti Gokhale

Smt. Taruben Popat

Smt. Mrinalini Desai

Scrutiny : Dr Jayashri Atre

Shri. V. D. Godbole

Co-ordination :

Dhanavanti Hardikar

Academic Secretary for Languages

Santosh Pawar

Assistant Special officer, English

Production :

Sachin Mehta

Chief Production Officer

Sanjay Kamble, Production Officer

Prashant Harne, Asst. Production Officer

Typesetting : D.T.P Section

Textbook Bureau, Pune.

Paper : 70 GSM Cream wove

Printer : HARSHWARDHAN OFFSET, KOLHAPUR

Print Order No. : N/PB/2022-23/1,10,000

Publisher

Vivek Uttam Gosavi, Controller
Maharashtra State Textbook Bureau,
Prabhadevi, Mumbai - 400 025.



The Constitution of India

Preamble

WE, THE PEOPLE OF INDIA, having solemnly resolved to constitute India into a SOVEREIGN SOCIALIST SECULAR DEMOCRATIC REPUBLIC and to secure to all its citizens :

JUSTICE, social, economic and political ;

LIBERTY of thought, expression, belief, faith and worship ;

EQUALITY of status and of opportunity ;
and to promote among them all

FRATERNITY assuring the dignity of the individual and the unity and integrity of the Nation ;

IN OUR CONSTITUENT ASSEMBLY this twenty-sixth day of November, 1949, do HEREBY ADOPT, ENACT AND GIVE TO OURSELVES THIS CONSTITUTION.

NATIONAL ANTHEM

Jana-gana-mana-adhināyaka jaya hē
Bhārata-bhāgya-vidhātā,

Panjāba-Sindhu-Gujarāta-Marāthā
Drāvida-Utkala-Banga

Vindhya-Himāchala-Yamunā-Gangā
uchchala-jaladhi-taranga

Tava subha nāmē jāgē, tava subha āsisa māgē,
gāhē tava jaya-gāthā,

Jana-gana-mangala-dāyaka jaya hē
Bhārata-bhāgya-vidhātā,

Jaya hē, Jaya hē, Jaya hē,
Jaya jaya jaya, jaya hē.

PLEDGE

India is my country. All Indians
are my brothers and sisters.

I love my country, and I am proud
of its rich and varied heritage. I shall
always strive to be worthy of it.

I shall give my parents, teachers
and all elders respect, and treat
everyone with courtesy.

To my country and my people,
I pledge my devotion. In their
well-being and prosperity alone lies
my happiness.

Preface

Dear Students,

Welcome to the ninth standard!

You are now going to begin your studies at the secondary level after completing your primary education curriculum. You had only one Mathematics textbook up to the eighth standard, now you will use two textbooks – Mathematics Part-I and Mathematics Part-II.

In this Mathematics Part-I textbook, you will get acquainted with several topics in the areas of Numbers, Algebra, Commercial Mathematics and Data Handling. These topics are useful for all students in various fields. Algebra and Statistics will provide the foundation for higher studies.

Different activities are given in the textbook to help you understand the different concepts. Other activities have been provided for revision and additional practice. You are expected to do all these. You can also explore the internet to get more information regarding concepts in the textbook and to obtain more practice examples. We expect you to do the activities, solve the examples and draw inferences after discussing them with your friends. You will get through the course joyfully if you follow the three point plan of – a deep study of the textbook, activity-based learning and ample practice.

So come on! Let us study Mathematics in the company of our teachers, parents, friends and the internet. Best wishes to you for your studies!



(Dr Sunil Magar)

Director

Pune

Date : 28 April, 2017

Akshaya Tritiya

Indian Solar Year :

8 Vaishakh 1939

Maharashtra State Bureau of Textbook
Production and Curriculum Research, Pune.

**It is expected that students will develop the following competencies
after studying the syllabus of Mathematics Part I in Standard IX**

Area	Topic	Competency statement
1. Knowledge of Numbers	1.1 Sets 1.2 Real numbers and quadratic surds	Students will be able to– <ul style="list-style-type: none"> ● know the different sets of numbers in the number system. ● determine the subset relation between pairs of sets. ● identify finite and infinite sets. ● use Venn diagrams to show relation between different sets. ● construct examples on sets. ● understand that every point on a number line is associated with a real number. ● identify the surds of order two and perform mathematical operations on them.
2. Algebra	2.1 Polynomial 2.2 Linear equations in two variables	<ul style="list-style-type: none"> ● identify polynomials and do operations on them. ● solve word problems using two variables.
3. Commercial Mathematics	3.1 Financial planning 3.2 Ratio and proportion	<ul style="list-style-type: none"> ● know about the tax system and compute taxes. ● compute income tax for salaried persons. ● use theorem on equal ratios. ● solve word problems based on direct and inverse variation.
4. Data handling (Statistics)	4.1 Frequency distribution 4.2 Measures of central tendency	<ul style="list-style-type: none"> ● prepare grouped and ungrouped frequency distribution tables. ● prepare cumulative frequency tables. ● find and make use of measures of central tendencies for the given data.

Instructions for teachers

The textbook 'Mathematics Part I' contains many fundamental concepts. Some concepts are developed according to the principle 'from concrete to abstract'. The book also contains concepts in Economics related to Mathematics and some extension of Mathematics of the area of statistics. Teachers are expected to study them in detail. It is also expected that a teacher should make use of activities, discussions, question-answers, group projects etc. while teaching the subject. The teacher should read the textbook thoroughly, note the activities given in the book and encourage the students to do them. The teacher should also try to invent new activities.

It is more important to understand basic concepts in Mathematics rather than the calculations. Many examples are included in the book which will develop student's logical thinking. The teachers are advised to construct such examples with the help of the students. In the textbook, some examples are star marked, which indicates that they require a little higher order of thinking. If students solve examples logically but with a different method, please do encourage them.

In the process of evaluation, it is advised to think of open ended questions and activity sheets. Teachers should endeavour to develop such methods of evaluation.

The list of practicals given in the textbook should be taken as a specimen. Teachers can frame different practicals of their own. Different activities in the textbook are included in the practicals. Encourage the students to do those activities also. We hope that the evaluation method based on them will be helpful to develop different competencies in further studies.

List of some practicals (specimen)

- (1) Consider your class as a universal set and draw Venn diagrams for the set of students who play Kho-kho, Kabbadi or any other games.
- (2) Represent $2 + \sqrt{3}$, $5 - \sqrt{2}$ etc. on the number line.
- (3) Divide a polynomial of degree three or four by a linear polynomial using different methods of division and check whether the answers are unique.
- (4) By using the given tables compute the income tax of a salaried person whose statements of income and investments are given.
- (5) Prepare a group frequency distribution table for the given numerical data.
- (6) Find the percentage of various components using an easily available strip of medical tablets.
- (7) To solve some challenging problems based on Linear equations using two variables.

Index

Chapters	Pages
1. Sets	1 to 18
2. Real Numbers	19 to 35
3. Polynomials	36 to 56
4. Ratio and Proportion	57 to 79
5. Linear Equations in Two Variables	80 to 92
6. Financial Planning	93 to 107
7. Statistics	108 to 128
● Answers	129 to 136

1

Sets





Let's study.

- Sets - Introduction
- Types of sets
- Venn diagrams
- Equal sets, subset
- Universal set
- Intersection and Union of sets
- Number of elements in a set



Let's recall.

Some pictures are given below. It contains the group of things you know.

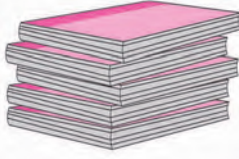
				1, 2, 3, 4, 5, 6, 7, 8, 9, 10, 11, 12, ...
Flower bouquet	Bunch of keys	Flock of birds	Pile of note-books	Collection of numbers

We use special word for each of the collection given above. In all the above examples we can clearly list the objects of that collection. We call the collection of such objects as **'Set'**.

Now, observe the collection. 'Happy children in the village', 'Brilliant students of the class'. In both the examples the words 'Happy' and 'Brilliant' are relative terms, because the exact meaning of these words 'to be happy' and 'to be brilliant' differ from person to person. Therefore, these collections are not sets.

See the examples given below and decide whether it is a set or not.

- (1) Days of a week
- (2) Months in a year
- (3) Brave children in the class
- (4) First 10 counting numbers
- (5) Strong forts of Maharashtra
- (6) Planets in our solar system



Let's learn.

Sets

If we can definitely and clearly decide the objects of a given collection then that collection is called a set.

Generally the name of the set is given using capital letters A, B, C, \dots, Z

The members or elements of the set are shown by using small letters a, b, c, \dots

If a is an element of set A , then we write it as ' $a \in A$ ' and if a is not an element of set A then we write ' $a \notin A$ ' .

Now let us observe the set of numbers.

$N = \{ 1, 2, 3, \dots \}$ is a set of natural numbers.

$W = \{0, 1, 2, 3, \dots\}$ is a set of whole numbers.

$I = \{\dots, -3, -2, -1, 0, 1, 2, \dots\}$ is a set of integers.

Q is a set of rational numbers.

R is a set of real numbers.

Methods of writing sets

There are two methods of writing set.

(1) Listing method or roster method

In this method, we write all the elements of a set in curly bracket. Each of the elements is written only once and separated by commas. The order of an element is not important but it is necessary to write all the elements of the set.

e.g. the set of odd numbers between 1 and 10, can be written as

as, $A = \{3, 5, 7, 9\}$ or $A = \{7, 3, 5, 9\}$

If an element comes more than once then it is customary to write that element only once. e.g. in the word 'remember' the letters 'r, m, e' are repeated more than once. So the set of letters of this word is written as $A = \{r, e, m, b\}$

(2) Rule method or set builder form

In this method, we do not write the list of elements but write the general element using variable followed by a vertical line or colon and write the property of the variable.

e.g. $A = \{x \mid x \in N, 1 < x < 10\}$ and read as 'set A is the set of all ' x ' such that ' x ' is a natural number between 1 and 10'.

e.g. $B = \{ x \mid x \text{ is a prime number between 1 and 10} \}$

set B contains all the prime numbers between 1 and 10. So by using listing method set B can be written as $B = \{2, 3, 5, 7\}$.

Q is the set of rational numbers which can be written in set builder form as

$$Q = \left\{ \frac{p}{q} \mid p, q \in \mathbb{I}, q \neq 0 \right\}$$

and read as 'Q' is set of all numbers in the form $\frac{p}{q}$ such that p and q are integers where q is a non-zero number.'

Illustrations : In the following examples each set is written in both the methods.

Rule method or Set builder form

Listing method or Roster method

$A = \{ x \mid x \text{ is a letter of the word 'DIVISION'.} \}$

$A = \{D, I, V, S, O, N\}$

$B = \{ y \mid y \text{ is a number such that } y^2 = 9 \}$

$B = \{ -3, 3 \}$

$C = \{ z \mid z \text{ is a multiple of 5 and is less than 30} \}$

$C = \{ 5, 10, 15, 20, 25 \}$

Ex. : Fill in the blanks given in the following table.

Listing or Roster Method	Rule Method
$A = \{ 2, 4, 6, 8, 10, 12, 14 \}$	$A = \{ x \mid x \text{ is an even natural number less than 15} \}$
.....	$B = \{ x \mid x \text{ is a perfect square number between 1 to 20} \}$
$C = \{ a, e, i, o, u \}$
.....	$D = \{ y \mid y \text{ is a colour in the rainbow} \}$
.....	$P = \{ x \mid x \text{ is an integer and } , -3 < x < 3 \}$
$M = \{ 1, 8, 27, 64, 125, \dots \}$

Practice set 1.1

- (1) Write the following sets in roster form.
 - (i) Set of even natural numbers (ii) Set of even prime numbers from 1 to 50
 - (iii) Set of negative integers (iv) Seven basic sounds of a sargam (sur)
- (2) Write the following symbolic statements in words.
 - (i) $\frac{4}{3} \in \mathbb{Q}$ (ii) $-2 \notin \mathbb{N}$ (iii) $P = \{ p \mid p \text{ is an odd number} \}$

- (3) Write any two sets by listing method and by rule method.
- (4) Write the following sets using listing method.
- All months in the indian solar year.
 - Letters in the word 'COMPLEMENT'.
 - Set of human sensory organs.
 - Set of prime numbers from 1 to 20.
 - Names of continents of the world.
- (5) Write the following sets using rule method.
- $A = \{ 1, 4, 9, 16, 25, 36, 49, 64, 81, 100 \}$
 - $B = \{ 6, 12, 18, 24, 30, 36, 42, 48 \}$
 - $C = \{ S, M, I, L, E \}$
 - $D = \{ \text{Sunday, Monday, Tuesday, Wednesday, Thursday, Friday, Saturday} \}$
 - $X = \{ a, e, t \}$



Let's learn.

Types of sets

Name of set	Definition	Example
Singleton Set	A set consisting of a single element is called a singleton set.	$A = \{2\}$ A is the set of even prime numbers.
Empty Set or Null Set	If there is not a single element in the set which satisfies the given condition then it is called a Null set or an empty set. Null set is represented by $\{ \}$ or a symbol ϕ (phi)	$B = \{x x \text{ is natural number between } 2 \text{ and } 3.\}$ $\therefore B = \{ \}$ or ϕ
Finite Set	If a set is a null set or number of elements are limited and countable then it is called as 'Finite set'.	$C = \{p p \text{ is a number from } 1 \text{ to } 22 \text{ divisible by } 4.\}$ $C = \{4, 8, 12, 16, 20\}$
Infinite Set	If number of elements in a set is unlimited and uncountable then the set is called 'Infinite set'.	$N = \{1, 2, 3, \dots \}$

Ex. Write the following sets using listing method and classify into finite or infinite set.

- (i) $A = \{x \mid x \in \mathbb{N} \text{ and } x \text{ is an odd number}\}$ (ii) $B = \{x \mid x \in \mathbb{N} \text{ and } 3x - 1 = 0\}$
(iii) $C = \{x \mid x \in \mathbb{N}, \text{ and } x \text{ is divisible by } 7\}$
(iv) $D = \{(a, b) \mid a, b \in \mathbb{W}, a + b = 9\}$ (v) $E = \{x \mid x \in \mathbb{I}, x^2 = 100\}$
(vi) $F = \{(a, b) \mid a, b \in \mathbb{Q}, a + b = 11\}$

Solution : (i) $A = \{x \mid x \in \mathbb{N} \text{ and } x \text{ is an odd number.}\}$

$A = \{1, 3, 5, 7, \dots\}$ This is an infinite set.

(ii) $B = \{x \mid x \in \mathbb{N} \text{ and } 3x - 1 = 0\}$

$$3x - 1 = 0 \quad \therefore 3x = 1 \quad x = \frac{1}{3}$$

But $\frac{1}{3} \notin \mathbb{N} \quad \therefore B = \{ \quad \} \quad \therefore B$ is finite set.

(iii) $C = \{x \mid x \in \mathbb{N} \text{ and } x \text{ is divisible by } 7.\}$

$C = \{7, 14, 21, \dots\}$ This is an infinite set.

(iv) $D = \{(a, b) \mid a, b \in \mathbb{W}, a + b = 9\}$

We have to find the pairs of a and b such that, a and b are whole numbers and $a + b = 9$.

Let us first write the value of a and then the value of b . By keeping this order set D can be written as

$$D = \{(0, 9), (1, 8), (2, 7), (3, 6), (4, 5), (5, 4), (6, 3), (7, 2), (8, 1), (9, 0)\},$$

In this set, number of pairs are finite and could be counted.

\therefore Set D is a finite set.

(v) $E = \{x \mid x \in \mathbb{I}, x^2 = 100\}$

$E = \{-10, 10\}$. $\therefore E$ is a finite set.

(vi) $F = \{(a, b) \mid a, b \in \mathbb{Q}, a + b = 11\}$

$F = \{(6, 5), (3, 8), (3.5, 7.5), (-15, 26), \dots\}$ infinitely many such pairs can be written.

$\therefore F$ is an infinite set.



Remember this !

$\mathbb{N}, \mathbb{W}, \mathbb{I}, \mathbb{Q}, \mathbb{R}$ all these sets are infinite sets.



Let's learn.

Equal sets

Two sets A and B are said to be equal, if every element of set A is in set B and every element of set B is in set A.

'Set A and set B are equal sets', symbolically it is written as $A = B$.

Ex (1) $A = \{ x \mid x \text{ is a letter of the word 'listen'}. \}$ $\therefore A = \{ l, i, s, t, e, n \}$

$B = \{ y \mid y \text{ is a letter of the word 'silent'}. \}$ $\therefore B = \{ s, i, l, e, n, t \}$

Though the elements of set A and B are not in the same order but all the elements are identical.

$\therefore A = B$

Ex (2) $A = \{ x \mid x = 2n, n \in \mathbb{N}, 0 < x \leq 10 \}$, $A = \{ 2, 4, 6, 8, 10 \}$

$B = \{ y \mid y \text{ is an even number, } 1 \leq y \leq 10 \}$, $B = \{ 2, 4, 6, 8, 10 \}$

\therefore A and B are equal sets.

Now think of the following sets.

$C = \{ 1, 3, 5, 7 \}$ $D = \{ 2, 3, 5, 7 \}$

Are C and D equal sets ? Obviously 'No'

Because $1 \in C, 1 \notin D, 2 \in D, 2 \notin C$

\therefore C and D are not equal sets. It is written as $C \neq D$

Ex (3) If $A = \{ 1, 2, 3 \}$ and $B = \{ 1, 2, 3, 4 \}$ then $A \neq B$ verify it.

Ex (4) $A = \{ x \mid x \text{ is prime number and } 10 < x < 20 \}$ and $B = \{ 11, 13, 17, 19 \}$

Here $A = B$. Verify,

Practice set 1.2

(1) Decide which of the following are equal sets and which are not ? Justify your answer.

$A = \{ x \mid 3x - 1 = 2 \}$

$B = \{ x \mid x \text{ is a natural number but } x \text{ is neither prime nor composite.} \}$

$C = \{ x \mid x \in \mathbb{N}, x < 2 \}$

(2) Decide whether set A and B are equal sets. Give reason for your answer.

$A = \text{Even prime numbers}$ $B = \{ x \mid 7x - 1 = 13 \}$

(3) Which of the following are empty sets ? why ?

(i) $A = \{ a \mid a \text{ is a natural number smaller than zero.} \}$

(ii) $B = \{ x \mid x^2 = 0 \}$ (iii) $C = \{ x \mid 5x - 2 = 0, x \in \mathbb{N} \}$

(4) Write with reasons, which of the following sets are finite or infinite.

- (i) $A = \{ x \mid x < 10, x \text{ is a natural number} \}$ (v) Set of apparatus in laboratory
 (ii) $B = \{ y \mid y < -1, y \text{ is an integer} \}$ (vi) Set of whole numbers
 (iii) $C = \text{Set of students of class 9 from your school.}$ (vii) Set of rational number
 (iv) Set of people from your village.



Let's learn.

Venn diagrams

British logician John Venn was the first to use closed figures to represent sets. Such representations are called 'Venn diagrams'. Venn diagrams are very useful, in order to understand and illustrate the relationship among sets and to solve the examples based on the sets.

Let us understand the use of Venn diagrams from the following example.

e.g. $A = \{ 1, 2, 3, 4, 5 \}$

Set A is shown by Venn diagram.

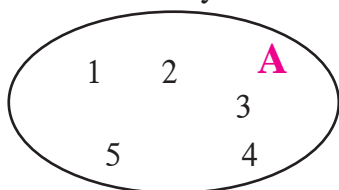

1834–1923

John Venn is the first Mathematician who gave the Mathematical form to 'logic' and 'probability'. His famous book is 'Logic of chance'.

$B = \{ x \mid -10 \leq x \leq 0, x \text{ is an integer} \}$

Venn diagram given alongside represents the set B.

0	-1	-2	-3
-4	-5	-6	-7 B
-8	-9	-10	

Subset

If A and B are two given sets and every element of set B is also an element of set A then B is a subset of A which is symbolically written as $B \subseteq A$. It is read as 'B is a subset of A' or 'B subset A'.

Ex (1) $A = \{ 1, 2, 3, 4, 5, 6, 7, 8 \}$

$B = \{ 2, 4, 6, 8 \}$

Every element of set B is also an element of set A.

$\therefore B \subseteq A$.

This can be represented by Venn diagram as shown above.

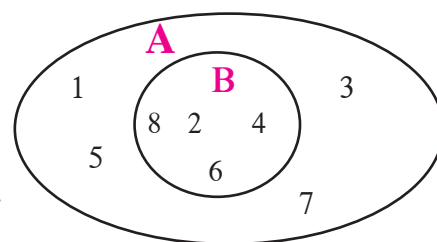

Activity : Set of students in a class and set of students in the same class who can swim, are shown by the Venn diagram.

Observe the diagram and draw Venn diagrams for the following subsets.

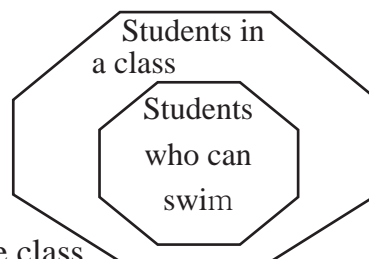

- (1) (i) set of students in a class
(ii) set of students who can ride bicycles in the same class
- (2) A set of fruits is given as follows.
{ guava, orange, mango, jack fruit, chickoo, jamun, custard apple, papaya, plum }
Show these subsets. (i) fruit with one seed (ii) fruit with more than one seed.

Let's see some more subsets.

Ex (2) N = set of natural numbers.

I = set of integers.

Here $N \subseteq I$. because all natural numbers are integers.

Ex (3) $P = \{ x \mid x \text{ is square root of } 25 \}$ $S = \{ y \mid y \in I, -5 \leq y \leq 5 \}$

Let's write set P as $P = \{-5, 5\}$

Let's write set S as $S = \{-5, -4, -3, -2, -1, 0, 1, 2, 3, 4, 5\}$

Here every element of set P is also an element of set S .

$\therefore P \subseteq S$



Remember this !

- (i) Every set is a subset of itself. i.e. $A \subseteq A$
- (ii) Empty set is a subset of every set i.e. $\phi \subseteq A$
- (iii) If $A = B$ then $A \subseteq B$ and $B \subseteq A$
- (iv) If $A \subseteq B$ and $B \subseteq A$ then $A = B$

Ex. If $A = \{ 1, 3, 4, 7, 8 \}$ then write all possible subsets of A .

i.e. $P = \{ 1, 3 \}$, $T = \{ 4, 7, 8 \}$, $V = \{ 1, 4, 8 \}$, $S = \{ 1, 4, 7, 8 \}$

In this way many subsets can be written. Write five more subsets of set A .

Activity : Every student should take 9 triangular sheets of paper and one plate. Numbers from 1 to 9 should be written on each triangle. Everyone should keep some numbered triangles in the plate. Now the triangles in each plate form a subset of the set of numbers from 1 to 9.

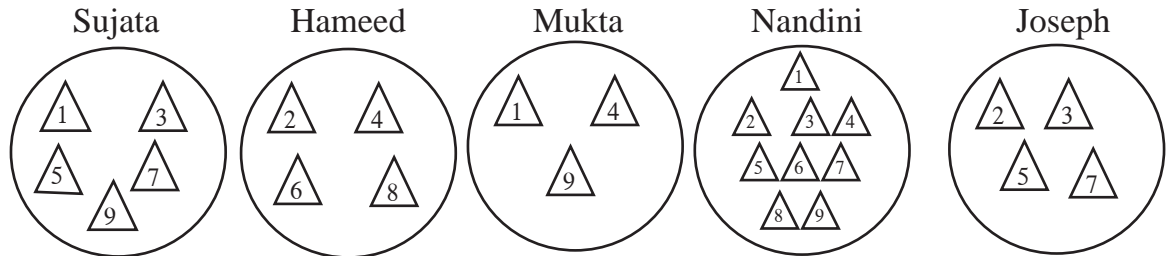

Look at the plates of Sujata, Hameed, Mukta, Nandini, Joseph with the numbered triangles. Guess the thinking behind selecting these numbers. Hence write the subsets in set builder form.



Ex.. Some sets are given below.

$$A = \{ \dots, -4, -2, 0, 2, 4, 6, \dots \} \quad B = \{ 1, 2, 3, \dots \}$$

$$C = \{ \dots, -12, -6, 0, 6, 12, 18, \dots \} \quad D = \{ \dots, -8, -4, 0, 4, 8, \dots \}$$

$$I = \{ \dots, -3, -2, -1, 0, 1, 2, 3, 4, \dots \}$$

Discuss and decide which of the following statements are true.

- (i) A is a subset of sets B, C and D.
- (ii) B is a subset of all the sets which are given above.



Universal set

Think of a bigger set which will accommodate all the given sets under consideration which in general is known as Universal set. So that the sets under consideration are the subsets of this Universal set.

Ex (1) Suppose we want to study the students in class 9 who frequently remained absent. Then we have to think of all the students of class 9 who are in the school. So all the students in a school or the students of all the divisions of class 9 in the school is the Universal set.

Let us see the another example.

Ex (2) A cricket team of 15 students is to be selected from a school. Here all the students from school who play cricket is the Universal set. A team of 15 cricket players is a subset of that Universal set.

Generally, the universal set is denoted by 'U' and in Venn diagram it is represented by a rectangle.

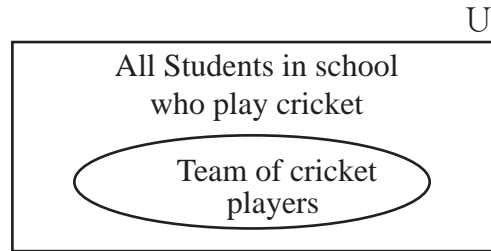

Complement of a set

Suppose U is an universal set. If $B \subseteq U$, then the set of all elements in U, which are not in set B is called the complement of B. It is denoted by B' or B^c .

B' is defined as follows.

$$B' = \{x \mid x \in U, \text{ and } x \notin B\}$$

Ex (1) $U = \{1, 2, 3, 4, 5, 6, 7, 8, 9, 10\}$

$$A = \{2, 4, 6, 8, 10\}$$

$$\therefore A' = \{1, 3, 5, 7, 9\}$$

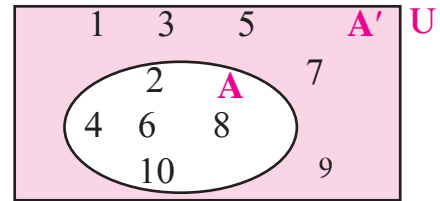

Ex (2) Suppose $U = \{1, 3, 9, 11, 13, 18, 19\}$

$$B = \{3, 9, 11, 13\}$$

$$\therefore B' = \{1, 18, 19\}$$

Find $(B')'$ and draw the inference.

$(B')'$ is the set of elements which are not in B' but in U.

is $(B')' = B$?

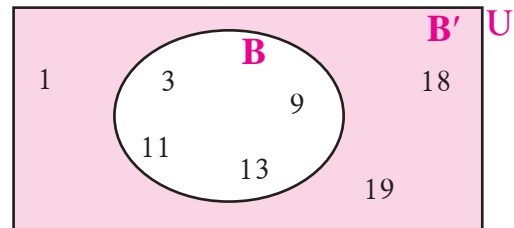

Understand this concept with the help of Venn diagram.

Complement of a complement is the given set itself.



Remember this !

Properties of complement of a set.

- (i) No elements are common in A and A' .
- (ii) $A \subseteq U$ and $A' \subseteq U$
- (iii) Complement of set U is empty set. $U' = \phi$
- (iv) Complement of empty set is U. $\phi' = U$

Practice set 1.3

- (1) If $A = \{a, b, c, d, e\}$, $B = \{c, d, e, f\}$, $C = \{b, d\}$, $D = \{a, e\}$
then which of the following statements are true and which are false ?
(i) $C \subseteq B$ (ii) $A \subseteq D$ (iii) $D \subseteq B$ (iv) $D \subseteq A$ (v) $B \subseteq A$ (vi) $C \subseteq A$
- (2) Take the set of natural numbers from 1 to 20 as universal set and show set X and Y using Venn diagram.
(i) $X = \{x \mid x \in \mathbb{N}, \text{ and } 7 < x < 15\}$
(ii) $Y = \{y \mid y \in \mathbb{N}, y \text{ is prime number from 1 to 20}\}$
- (3) $U = \{1, 2, 3, 7, 8, 9, 10, 11, 12\}$
 $P = \{1, 3, 7, 10\}$
then (i) show the sets U, P and P' by Venn diagram. (ii) Verify $(P')' = P$
- (4) $A = \{1, 3, 2, 7\}$ then write any three subsets of A.
- (5) (i) Write the subset relation between the sets.
P is the set of all residents in Pune.
M is the set of all residents in Madhya Pradesh.
I is the set of all residents in Indore.
B is the set of all residents in India.
H is the set of all residents in Maharashtra.
(ii) Which set can be the universal set for above sets ?
- (6*) Which set of numbers could be the universal set for the sets given below?
(i) A = set of multiples of 5, B = set of multiples of 7.
C = set of multiples of 12
(ii) P = set of integers which are multiples of 4.
T = set of all even square numbers.
- (7) Let all the students of a class is an Universal set. Let set A be the students who secure 50% or more marks in Maths. Then write the complement of set A.



Let's learn.

Operations on sets

Intersection of two sets

Suppose A and B are two sets. The set of all common elements of A and B is called the intersection of set A and B. It is denoted as $A \cap B$ and read as A intersection B.

$$\therefore A \cap B = \{x \mid x \in A \text{ and } x \in B\}$$

Ex (1) $A = \{ 1, 3, 5, 7 \}$ $B = \{ 2, 3, 6, 8 \}$

Let us draw Venn diagram.

The element 3 is common in set A and B.

$$\therefore A \cap B = \{3\}$$

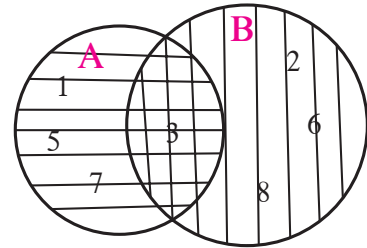

Ex (2) $A = \{1, 3, 9, 11, 13\}$ $B = \{1, 9, 11\}$

The elements 1, 9, 11 are common in set A and B.

$$\therefore A \cap B = \{1, 9, 11\} \quad \text{But } B = \{1, 9, 11\}$$

$$\therefore A \cap B = B$$

Here set B is the subset of A.

$$\therefore \text{If } B \subseteq A \text{ then } A \cap B = B, \quad \text{similarly, if } B \cap A = B, \text{ then } B \subseteq A$$

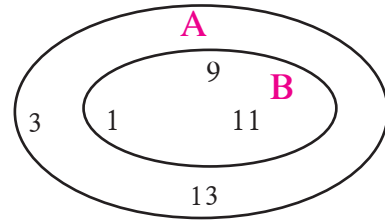

Remember this !

Properties of Intersection of sets

- | | |
|--|---|
| (1) $A \cap B = B \cap A$ | (2) If $A \subseteq B$ then $A \cap B = A$ |
| (3) If $A \cap B = B$ then $B \subseteq A$ | (4) $A \cap B \subseteq A$ and $A \cap B \subseteq B$ |
| (5) $A \cap A' = \phi$ | (6) $A \cap A = A$ (7) $A \cap \phi = \phi$ |

Activity : Take different examples of sets and verify the above mentioned properties.



Let's learn.

Disjoint sets

Let, $A = \{ 1, 3, 5, 9 \}$

and $B = \{2, 4, 8\}$ are given.

Confirm that not a single element is common in set

A and B. These sets are completely different from each other.

So the set A and B are disjoint sets. Observe its Venn diagram.

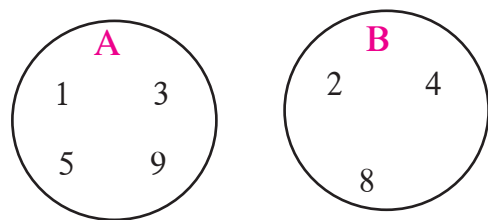

Activity I : Observe the set A, B, C given by Venn diagrams and write which of these are disjoint sets.

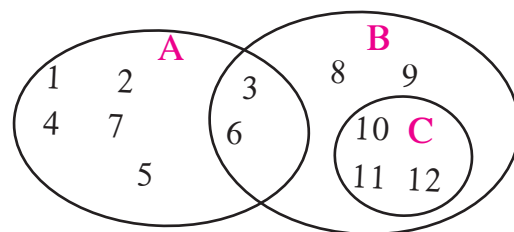

Activity II : Let the set of English alphabets be the Universal set.

The letters of the word 'LAUGH' is one set and the letter of the word 'CRY' is another set.

We can say that these are two disjoint sets.

Observe that intersection of these two sets is empty.

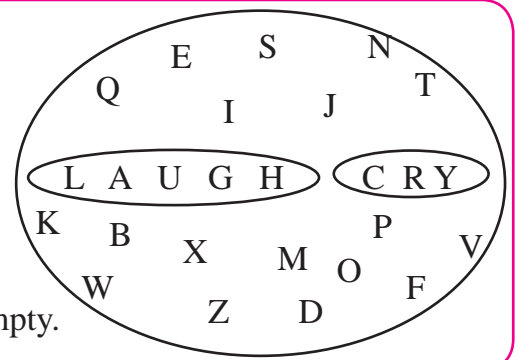

Union of two sets

Let A and B be two given sets. Then the set of all elements of set A and B is called the Union of two sets. It is written as $A \cup B$ and read as 'A union B'.

$$A \cup B = \{x \mid x \in A \text{ or } x \in B\}$$

Ex (1) $A = \{-1, -3, -5, 0\}$

$$B = \{0, 3, 5\}$$

$$A \cup B = \{-3, -5, 0, -1, 3, 5\}$$

Note that, $A \cup B = B \cup A$

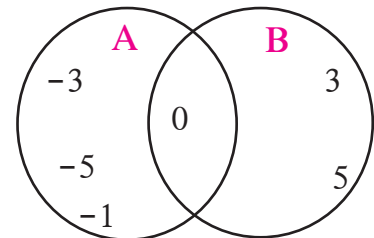

Ex (2)

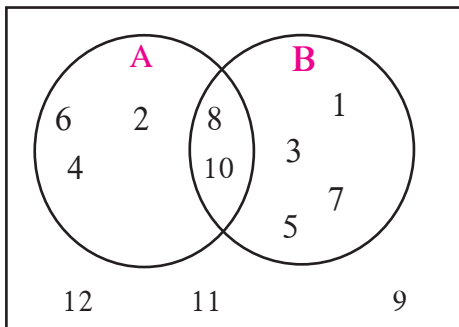

Observe the Venn diagram and write the following sets using listing method.

(i) U (ii) A (iii) B (iv) $A \cup B$ (v) $A \cap B$

(vi) A' (vii) B' (viii) $(A \cup B)'$ (ix) $(A \cap B)'$

Solution :

$$U = \{1, 2, 3, 4, 5, 6, 7, 8, 9, 10, 11, 12\}$$

$$A = \{2, 4, 6, 8, 10\},$$

$$B = \{1, 3, 5, 7, 8, 10\}$$

$$A \cup B = \{1, 2, 3, 4, 5, 6, 7, 8, 10\}$$

$$A \cap B = \{8, 10\}$$

$$A' = \{1, 3, 5, 7, 9, 11, 12\}$$

$$B' = \{2, 4, 6, 9, 11, 12\}$$

$$(A \cup B)' = \{9, 11, 12\}$$

$$(A \cap B)' = \{1, 2, 3, 4, 5, 6, 7, 9, 11, 12\}$$

Ex (3)

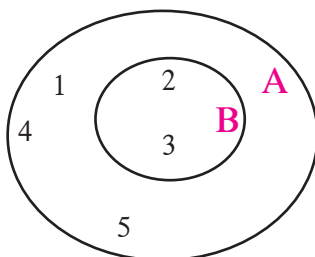

$$A = \{1, 2, 3, 4, 5\} \quad B = \{2, 3\}$$

Let us draw its Venn diagram.

$$A \cup B = \{1, 2, 3, 4, 5\}$$

Observe that set A and $A \cup B$ have the same elements.

Hence, if $B \subseteq A$ then $A \cup B = A$



Remember this !

Properties of Union of sets

- (1) $A \cup B = B \cup A$ (2) If $A \subseteq B$ then $A \cup B = B$
 (3) $A \subseteq A \cup B, B \subseteq A \cup B$ (4) $A \cup A' = U$
 (5) $A \cup A = A$ (6) $A \cup \phi = A$



Let's learn.

Number of elements in a set

Let $A = \{3, 6, 9, 12, 15\}$ is a given set with 5 elements.

Number of elements in set A is denoted as $n(A)$. $\therefore n(A) = 5$

Let $B = \{6, 12, 18, 24, 30, 36\}$ $\therefore n(B) = 6$

Number of elements in Union and Intersection of sets.

Let us consider the set A and set B as given above,

$$n(A) + n(B) = 5 + 6 = 11 \text{ ----(I)}$$

$$A \cup B = \{3, 6, 9, 12, 15, 18, 24, 30, 36\} \therefore n(A \cup B) = 9 \text{ -----(II)}$$

To find $A \cap B$ means to find common elements of set A and set B.

$$A \cap B = \{6, 12\} \therefore n(A \cap B) = 2 \text{ -----(III)}$$

In $n(A)$ and $n(B)$ elements in $A \cap B$ are counted twice.

$$\therefore n(A) + n(B) - n(A \cap B) = 5 + 6 - 2 = 9 \text{ and } n(A \cup B) = 9$$

From equations (I), (II) and (III), we can write it as follows.

$$\therefore n(A \cup B) = n(A) + n(B) - n(A \cap B)$$

Verify the above rule for the given Venn diagram.

$$n(A) = \square, n(B) = \square$$

$$n(A \cup B) = \square, n(A \cap B) = \square$$

$$\therefore n(A \cup B) = n(A) + n(B) - n(A \cap B)$$



Remember this !

$$n(A \cup B) = n(A) + n(B) - n(A \cap B)$$

$$\text{means } n(A) + n(B) = n(A \cup B) + n(A \cap B)$$

Ex. Let $A = \{1, 2, 3, 5, 7, 9, 11, 13\}$ $B = \{1, 2, 4, 6, 8, 12, 13\}$

Verify the above rule for the given set A and set B.



Let's learn.

Word problems based on sets

Ex. In a class of 70 students, 45 students like to play Cricket. 52 students like to play Kho-kho. All the students like to play atleast one of the two games. How many students like to play Cricket or Kho-kho? How many students like to play only Cricket?

Solution : We will solve this example in two ways.

Method I : Total number of students = 70

Let A be the set of students who likes to play Cricket.

Let B be the set of students who likes to play Kho-kho.

Hence the number of students who likes to play Cricket or Kho-kho is $n(A \cup B)$

$$\therefore n(A \cup B) = 70$$

Number of students who likes to play both Cricket and Kho-kho = $n(A \cap B)$

$$n(A) = 45, \quad n(B) = 52$$

We know, $n(A \cup B) = n(A) + n(B) - n(A \cap B)$.

$$\begin{aligned} \therefore n(A \cap B) &= n(A) + n(B) - n(A \cup B) \\ &= 45 + 52 - 70 = 27 \end{aligned}$$

\therefore Number of students who likes to play both the games are 27,

Number of students who likes to play Kho-kho are 45.

\therefore Number of students who likes to play only Cricket = $45 - 27 = 18$

$\therefore A \cap B$ is the set of students who play both the games. $\therefore n(A \cap B) = 27$

Method II : Given information can be shown by Venn diagrams as follows.

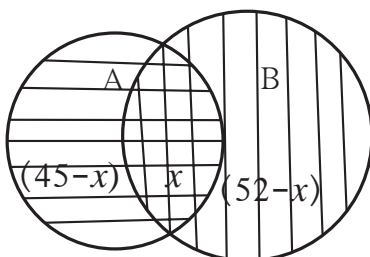

Let $n(A \cap B) = x$, $n(A) = 45$, $n(B) = 52$,

We know that, $n(A \cup B) = 70$

$$\begin{aligned} \therefore n(A \cap B) = x &= n(A) + n(B) - n(A \cup B) \\ &= 45 + 52 - 70 = 27 \end{aligned}$$

Students who like to play only cricket = $45 - 27$
= 18

Practice set 1.4

- (1) If $n(A) = 15$, $n(A \cup B) = 29$, $n(A \cap B) = 7$ then $n(B) = ?$
- (2) In a hostel there are 125 students, out of which 80 drink tea, 60 drink coffee and 20 drink tea and coffee both. Find the number of students who do not drink tea or coffee.
- (3) In a competitive exam 50 students passed in English. 60 students passed in Mathematics. 40 students passed in both the subjects. None of them fail in both the subjects. Find the number of students who passed at least in one of the subjects ?
- (4*) A survey was conducted to know the hobby of 220 students of class IX. Out of which 130 students informed about their hobby as rock climbing and 180 students informed about their hobby as sky watching. There are 110 students who follow both the hobbies. Then how many students do not have any of the two hobbies ? How many of them follow the hobby of rock climbing only ? How many students follow the hobby of sky watching only ?
- (5) Observe the given Venn diagram and write the following sets.

- (i) A (ii) B (iii) $A \cup B$ (iv) U
 (v) A' (vi) B' (vii) $(A \cup B)'$

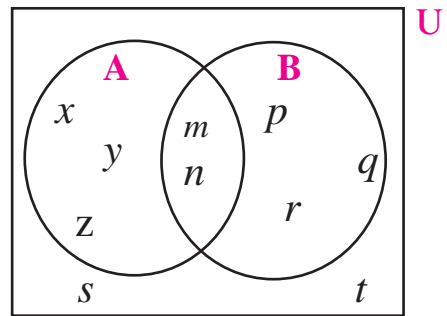

Problem set 1

- (1) Choose the correct alternative answer for each of the following questions.
 - (i) If $M = \{1, 3, 5\}$, $N = \{2, 4, 6\}$, then $M \cap N = ?$
 (A) $\{1, 2, 3, 4, 5, 6\}$ (B) $\{1, 3, 5\}$ (C) ϕ (D) $\{2, 4, 6\}$
 - (ii) $P = \{x \mid x \text{ is an odd natural number, } 1 < x \leq 5\}$
 How to write this set in roster form?
 (A) $\{1, 3, 5\}$ (B) $\{1, 2, 3, 4, 5\}$ (C) $\{1, 3\}$ (D) $\{3, 5\}$
 - (iii) $P = \{1, 2, \dots, 10\}$, What type of set P is ?
 (A) Null set (B) Infinite set (C) Finite set (D) None of these
 - (iv) $M \cup N = \{1, 2, 3, 4, 5, 6\}$ and $M = \{1, 2, 4\}$ then which of the following represent set N ?
 (A) $\{1, 2, 3\}$ (B) $\{3, 4, 5, 6\}$ (C) $\{2, 5, 6\}$ (D) $\{4, 5, 6\}$

- (v) If $P \subseteq M$, then Which of the following set represent $P \cap (P \cup M)$?
 (A) P (B) M (C) $P \cup M$ (D) $P' \cap M$
- (vi) Which of the following sets are empty sets ?
 (A) set of intersecting points of parallel lines (B) set of even prime numbers.
 (C) Month of an english calendar having less than 30 days.
 (D) $P = \{x \mid x \in I, -1 < x < 1\}$
- (2) Find the correct option for the given question.
- (i) Which of the following collections is a set ?
 (A) Colours of the rainbow (B) Tall trees in the school campus
 (C) Rich people in the village (D) Easy examples in the book
- (ii) Which of the following set represent $N \cap W$?
 (A) $\{1, 2, 3, \dots\}$ (B) $\{0, 1, 2, 3, \dots\}$ (C) $\{0\}$ (D) $\{ \}$
- (iii) $P = \{x \mid x \text{ is a letter of the word 'indian'}\}$ then which one of the following is set P in listing form ?
 (A) $\{i, n, d\}$ (B) $\{i, n, d, a\}$ (C) $\{i, n, d, i, a\}$ (D) $\{n, d, a\}$
- (iv) If $T = \{1, 2, 3, 4, 5\}$ and $M = \{3, 4, 7, 8\}$ then $T \cup M = ?$
 (A) $\{1, 2, 3, 4, 5, 7\}$ (B) $\{1, 2, 3, 7, 8\}$
 (C) $\{1, 2, 3, 4, 5, 7, 8\}$ (D) $\{3, 4\}$
- (3) Out of 100 persons in a group, 72 persons speak English and 43 persons speak French. Each one out of 100 persons speak at least one language. Then how many speak only English ? How many speak only French ? How many of them speak English and French both ?
- (4) 70 trees were planted by Parth and 90 trees were planted by Pradnya on the occasion of Tree Plantation Week. Out of these; 25 trees were planted by both of them together. How many trees were planted by Parth or Pradnya ?
- (5) If $n(A) = 20$, $n(B) = 28$ and $n(A \cup B) = 36$ then $n(A \cap B) = ?$
- (6) In a class, 8 students out of 28 have only dog as their pet animal at home, 6 students have only cat as their pet animal. 10 students have dog and cat both, then how many students do not have a dog or cat as their pet animal at home ?
- (7) Represent the union of two sets by Venn diagram for each of the following.
- (i) $A = \{3, 4, 5, 7\}$ $B = \{1, 4, 8\}$
- (ii) $P = \{a, b, c, e, f\}$ $Q = \{l, m, n, e, b\}$

(iii) $X = \{x \mid x \text{ is a prime number between } 80 \text{ and } 100\}$

$Y = \{y \mid y \text{ is an odd number between } 90 \text{ and } 100\}$

(8) Write the subset relations between the following sets

$X =$ set of all quadrilaterals

$Y =$ set of all rhombuses

$S =$ set of all squares

$T =$ set of all parallelograms

$V =$ set of all rectangles

(9) If M is any set, then write $M \cup \phi$ and $M \cap \phi$.

(10*)

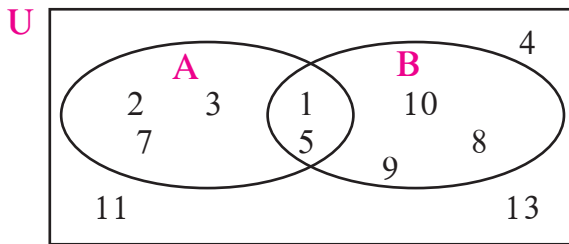

Observe the Venn diagram and write the given sets $U, A, B, A \cup B$ and $A \cap B$.

(11) If $n(A) = 7, n(B) = 13, n(A \cap B) = 4$, then $n(A \cup B) = ?$

Activity I : Fill in the blanks with elements of that set.

$U = \{1, 3, 5, 8, 9, 10, 11, 12, 13, 15\}$

$A = \{1, 11, 13\}$

$B = \{8, 5, 10, 11, 15\}$

$A' = \{\dots\dots\dots\}$ $B' = \{\dots\dots\dots\}$

$A \cap B = \{\dots\dots\dots\}$

$A' \cap B' = \{\dots\dots\dots\}$

$A \cup B = \{\dots\dots\dots\}$

$A' \cup B' = \{\dots\dots\dots\}$

$(A \cap B)' = \{\dots\dots\dots\}$

$(A \cup B)' = \{\dots\dots\dots\}$

Verify : $(A \cap B)' = A' \cup B', (A \cup B)' = A' \cap B'$

Activity II : Collect the following information from 20 families nearby your house.

(i) Number of families subscribing for Marathi Newspaper.

(ii) Number of families subscribing for English Newspaper.

(iii) Number of families subscribing for both English as well as Marathi Newspaper.

Show the collected information using Venn diagram.



2

Real Numbers



Let's study.

- Properties of rational numbers
- Properties of irrational numbers
- Surds
- Comparison of quadratic surds
- Operations on quadratic surds
- Rationalization of quadratic surds.



Let's recall.

In previous classes we have learnt about Natural numbers, Integers and Real numbers.

N = Set of Natural numbers = $\{1, 2, 3, 4, \dots\}$

W = Set of Whole numbers = $\{0, 1, 2, 3, 4, \dots\}$

I = Set of Integers = $\{\dots, -3, -2, -1, 0, 1, 2, 3, \dots\}$

Q = Set of Rational numbers = $\{\frac{p}{q} \mid p, q \in I, q \neq 0\}$

R = Set of Real numbers.

$N \subseteq W \subseteq I \subseteq Q \subseteq R$.

Order relation on rational numbers :

$\frac{p}{q}$ and $\frac{r}{s}$ are rational numbers where $q > 0, s > 0$

(i) If $p \times s = q \times r$ then $\frac{p}{q} = \frac{r}{s}$ (ii) If $p \times s > q \times r$ then $\frac{p}{q} > \frac{r}{s}$

(iii) If $p \times s < q \times r$ then $\frac{p}{q} < \frac{r}{s}$



Let's learn.

Properties of rational numbers

If a, b, c are rational numbers then

Property	Addition	Multiplication
1. Commutative	$a + b = b + a$	$a \times b = b \times a$
2. Associative	$(a + b) + c = a + (b + c)$	$a \times (b \times c) = (a \times b) \times c$
3. Identity	$a + 0 = 0 + a = a$	$a \times 1 = 1 \times a = a$
4. Inverse	$a + (-a) = 0$	$a \times \frac{1}{a} = 1 \quad (a \neq 0)$



Let's recall.

Decimal form of any rational number is either terminating or non-terminating recurring type.

Terminating type

$$(1) \frac{2}{5} = 0.4$$

$$(2) -\frac{7}{64} = -0.109375$$

$$(3) \frac{101}{8} = 12.625$$

Non terminating recurring type

$$(1) \frac{17}{36} = 0.472222... = 0.47\dot{2}$$

$$(2) \frac{33}{26} = 1.2692307692307... = 1.2\overline{692307}$$

$$(3) \frac{56}{37} = 1.513513513... = 1.\overline{513}$$



Let's learn.

To express the recurring decimal in $\frac{p}{q}$ form.

Ex. (1) Express the recurring decimal $0.777...$ in $\frac{p}{q}$ form.

Solution : Let $x = 0.777... = 0.\dot{7}$

$$\therefore 10x = 7.777... = 7.\dot{7}$$

$$\therefore 10x - x = 7.\dot{7} - 0.\dot{7}$$

$$\therefore 9x = 7$$

$$\therefore x = \frac{7}{9}$$

$$\therefore 0.777... = \frac{7}{9}$$

Ex. (2) Express the recurring decimal $7.529529529...$ in $\frac{p}{q}$ form.

Solution : Let $x = 7.529529... = 7.\overline{529}$

$$\therefore 1000x = 7529.529529... = 7529.\overline{529}$$

$$\therefore 1000x - x = 7529.\overline{529} - 7.\overline{529}$$

$$\therefore 999x = 7522.0 \quad \therefore x = \frac{7522}{999}$$

$$\therefore 7.\overline{529} = \frac{7522}{999}$$



**Use your
brain power!**

How to convert
 $2.4\dot{3}$ in $\frac{p}{q}$ form ?

**Remember this !**

- (1) Note the number of recurring digits after decimal point in the given rational number. Accordingly multiply it by 10, 100, 1000.
- e.g. In $2.\dot{3}$, digit 3 is the only recurring digit after decimal point, hence to convert $2.\dot{3}$ in $\frac{p}{q}$ form multiply $2.\dot{3}$ by 10.
- In $1.\overline{24}$ digits 2 and 4 both are recurring therefore multiply $1.\overline{24}$ by 100.
- In $1.\overline{513}$ digits 5, 1 and 3 are recurring so multiply $1.\overline{513}$ by 1000.
- (2) Notice the prime factors of the denominator of a rational number. If the prime factors are 2 or 5 only then its decimal expansion is terminating. If the prime factors are other than 2 or 5 also then its decimal expansion is non terminating and recurring.

Practice set 2.1

- Classify the decimal form of the given rational numbers into terminating and non-terminating recurring type.

(i) $\frac{13}{5}$	(ii) $\frac{2}{11}$	(iii) $\frac{29}{16}$	(iv) $\frac{17}{125}$	(v) $\frac{11}{6}$
--------------------	---------------------	-----------------------	-----------------------	--------------------
- Write the following rational numbers in decimal form.

(i) $\frac{127}{200}$	(ii) $\frac{25}{99}$	(iii) $\frac{23}{7}$	(iv) $\frac{4}{5}$	(v) $\frac{17}{8}$
-----------------------	----------------------	----------------------	--------------------	--------------------
- Write the following rational numbers in $\frac{p}{q}$ form.

(i) $0.\dot{6}$	(ii) $0.\overline{37}$	(iii) $3.\overline{17}$	(iv) $15.\overline{89}$	(v) $2.\overline{514}$
-----------------	------------------------	-------------------------	-------------------------	------------------------

**Let's recall.**

The numbers $\sqrt{2}$ and $\sqrt{3}$ shown on a number line are not rational numbers means they are irrational numbers.

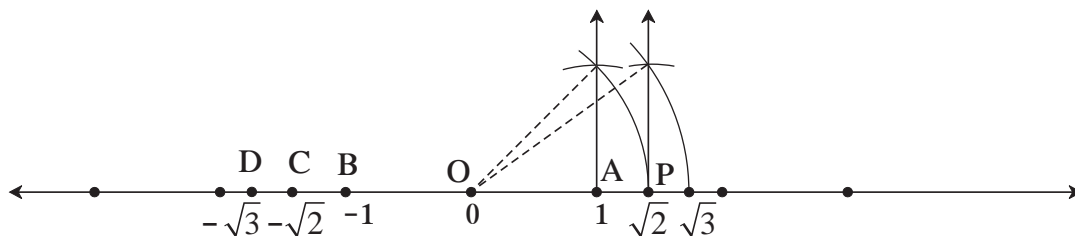

On a number line $OA = 1$ unit. Point B which is left to the point O is at a distance of 1 unit. Co-ordinate of point B is -1 . Co-ordinate of point P is $\sqrt{2}$ and its opposite number $-\sqrt{2}$ is shown by point C. The co-ordinate of point C is $-\sqrt{2}$. Similarly, opposite of $\sqrt{3}$ is $-\sqrt{3}$ which is the co-ordinate of point D.



Let's learn.

Irrational and real numbers

$\sqrt{2}$ is irrational number. This can be proved using indirect proof.

Let us assume that $\sqrt{2}$ is rational. So $\sqrt{2}$ can be expressed in $\frac{p}{q}$ form.

$\frac{p}{q}$ is the reduced form of rational number hence p and q have no common factor other than 1.

$$\sqrt{2} = \frac{p}{q} \quad \therefore \quad 2 = \frac{p^2}{q^2} \quad (\text{Squaring both the sides})$$

$$\therefore 2q^2 = p^2$$

$$\therefore p^2 \text{ is even.}$$

$$\therefore p \text{ is also even means } 2 \text{ is a factor of } p. \quad \dots(\text{I})$$

$$\therefore p = 2t \quad \therefore p^2 = 4t^2 \quad t \in \mathbb{I}$$

$$\therefore 2q^2 = 4t^2 \quad (\because p^2 = 2q^2) \quad \therefore q^2 = 2t^2 \quad \therefore q^2 \text{ is even. } \therefore q \text{ is even.}$$

$$\therefore 2 \text{ is a factor of } q. \quad \dots (\text{II})$$

From the statement (I) and (II), 2 is a common factor of p and q both.

This is contradictory because in $\frac{p}{q}$; we have assumed that p and q have no common factor except 1.

$$\therefore \text{ Our assumption that } \sqrt{2} \text{ is rational is wrong.}$$

$$\therefore \sqrt{2} \text{ is irrational number.}$$

Similarly, one can prove that $\sqrt{3}$, $\sqrt{5}$ are irrational numbers.

Numbers $\sqrt{2}$, $\sqrt{3}$, $\sqrt{5}$ can be shown on a number line.

The numbers which are represented by points on a number line are real numbers.

In a nutshell, **Every point on a number line is associated with a unique a 'Real number' and every real number is associated with a unique point on the number line.**

We know that every rational number is a real number. But $\sqrt{2}$, $\sqrt{3}$, $-\sqrt{2}$, π , $3 + \sqrt{2}$ etc. are not rational numbers. It means that **Every real number may not be a rational number.**

Decimal form of irrational numbers

Find the square root of 2 and 3 using division method.

Square root of 2

$$\begin{array}{r}
 1.41421\dots \\
 \hline
 1 \overline{) 2.00\ 00\ 00\ 00\dots} \\
 +1 \quad -1 \\
 \hline
 24 \quad 100 \\
 +4 \quad -96 \\
 \hline
 281 \quad 400 \\
 +1 \quad -281 \\
 \hline
 2824 \quad 11900 \\
 +4 \quad -11296 \\
 \hline
 28282 \quad 60400 \\
 +2 \quad -56564 \\
 \hline
 282841 \quad 0383600
 \end{array}$$

$$\therefore \sqrt{2} = 1.41421\dots$$

Square root of 3

$$\begin{array}{r}
 1.732\dots \\
 \hline
 1 \overline{) 3.00\ 00\ 00\ 00\dots} \\
 +1 \quad -1 \\
 \hline
 27 \quad 200 \\
 +7 \quad -189 \\
 \hline
 343 \quad 1100 \\
 +3 \quad -1029 \\
 \hline
 3462 \quad 007100 \\
 +2 \quad -6924 \\
 \hline
 3464 \quad 0176
 \end{array}$$

$$\therefore \sqrt{3} = 1.732\dots$$

Note that in the above division, numbers after decimal point are unending, means it is non-terminating. Even no group of numbers or a single number is repeating in its quotient. So decimal expansion of such numbers is non-terminating, non-recurring.

$\sqrt{2}, \sqrt{3}$ are irrational numbers hence 1.4142... and 1.732... are irrational numbers too. Moreover, **a number whose decimal expansion is non-terminating, non-recurring is irrational.**

Number π

Activity I

Draw three or four circles of different radii on a card board. Cut these circles. Take a thread and measure the length of circumference and diameter of each of the circles. Note down the readings in the given table.

No.	radius (r)	diameter (d)	circumference (c)	Ratio = $\frac{c}{d}$
1	7 cm			
2	8 cm			
3	5.5 cm			

From table the ratio $\frac{c}{d}$ is nearly 3.1 which is constant. This ratio is denoted by π (pi).

Activity II

To find the approximate value of π , take the wire of length 11 cm, 22 cm and 33 cm each. Make a circle from the wire. Measure the diameter and complete the following table.

Circle No.	Circumference (c)	Diameter (d)	Ratio of (c) to (d)
1	11 cm		
2	22 cm		
3	33 cm		

Verify ratio of circumference to the diameter of a circle is approximately $\frac{22}{7}$.

Ratio of the circumference of a circle to its diameter is constant number which is irrational. This constant number is represented by the symbol π . So the approximate value of π is $\frac{22}{7}$ or 3.14.

The great Indian mathematician Aryabhat in 499 CE has calculated the value of π as $\frac{62832}{20000} = 3.1416$.

We know that, $\sqrt{3}$ is an irrational number because its decimal expansion is non-terminating, non-recurring. Now let us see whether $2 + \sqrt{3}$ is irrational or not ?

Let us assume that, $2 + \sqrt{3}$ is not an irrational number.

If $2 + \sqrt{3}$ is rational then let $2 + \sqrt{3} = \frac{p}{q}$. \therefore We get $\sqrt{3} = \frac{p}{q} - 2$.

In this equation left side is an irrational number and right side rational number, which is contradictory, so $2 + \sqrt{3}$ is not a rational but it is an irrational number.

Similarly it can be proved that $2\sqrt{3}$ is irrational. The sum of two irrational numbers can be rational or irrational. Let us verify it for different numbers.

$$\begin{aligned} \text{i.e., } 2 + \sqrt{3} + (-\sqrt{3}) &= 2, & 4\sqrt{5} \div \sqrt{5} &= 4, & (3 + \sqrt{5}) - (\sqrt{5}) &= 3, \\ 2\sqrt{3} \times \sqrt{3} &= 6 & \sqrt{2} \times \sqrt{5} &= \sqrt{10}, & 2\sqrt{5} - \sqrt{5} &= \sqrt{5} \end{aligned}$$



Remember this !

Properties of irrational numbers

- (1) Addition or subtraction of a rational number with irrational number is an irrational number.
- (2) Multiplication or division of non zero rational number with irrational number is also an irrational number.
- (3) Addition, subtraction, multiplication and division of two irrational numbers can be either a rational or irrational number.



Let's learn.

Properties of order relation on Real numbers

1. If a and b are two real numbers then only one of the relations holds good.
i.e. $a = b$ or $a < b$ or $a > b$
 2. If $a < b$ and $b < c$ then $a < c$
 3. If $a < b$ then $a + c < b + c$
 4. If $a < b$ and $c > 0$ then $ac < bc$ and If $c < 0$ then $ac > bc$
- Verify the above properties using rational and irrational numbers.

Square root of a Negative number

We know that, if $\sqrt{a} = b$ then $b^2 = a$.

Hence if $\sqrt{5} = x$ then $x^2 = 5$.

Similarly we know that square of any real number is always non-negative. It means that square of any real number is never negative. But $(\sqrt{-5})^2 = -5 \therefore \sqrt{-5}$ is not a real number.

Hence square root of a negative real number is not a real number.

Practice set 2.2

- (1) Show that $4\sqrt{2}$ is an irrational number.
- (2) Prove that $3 + \sqrt{5}$ is an irrational number.
- (3) Represent the numbers $\sqrt{5}$ and $\sqrt{10}$ on a number line.
- (4) Write any three rational numbers between the two numbers given below.
 - (i) 0.3 and -0.5
 - (ii) -2.3 and -2.33
 - (iii) 5.2 and 5.3
 - (iv) -4.5 and -4.6



Let's learn.

Root of positive rational number

We know that, if $x^2 = 2$ then $x = \sqrt{2}$ or $x = -\sqrt{2}$, where. $\sqrt{2}$ and $-\sqrt{2}$ are irrational numbers. This we know, $\sqrt[3]{7}$, $\sqrt[4]{8}$, these numbers are irrational numbers too.

If n is a positive integer and $x^n = a$, then x is the n^{th} root of a . $x = \sqrt[n]{a}$. This root may be rational or irrational.

For example, $2^5 = 32 \therefore 2$ is the 5^{th} root of 32, but if $x^5 = 2$ then $x = \sqrt[5]{2}$, which is an irrational number.

Surds

We know that 5 is a rational number but $\sqrt{5}$ is not rational. Square root or cube root of any real number is either rational or irrational number. Similarly n^{th} root of any number is either rational or irrational.

If n is an integer greater than 1 and if a is a positive real number and n^{th} root of a is x then it is written as $x^n = a$ or $\sqrt[n]{a} = x$

If a is a positive rational number and n^{th} root of a is x and if x is an irrational number then x is called a surd. (Surd is an irrational root.)

In a surd $\sqrt[n]{a}$ the symbol $\sqrt{\quad}$ is called **radical sign**, n is the **Order of the surd** and a is called **radicand**.

- (1) Let $a = 7$, $n = 3$, then $\sqrt[3]{7}$ is a surd because $\sqrt[3]{7}$ is an irrational number.
- (2) Let $a = 27$, $n = 3$ then $\sqrt[3]{27}$ is not a surd because $\sqrt[3]{27} = 3$ is not an irrational number.
- (3) $\sqrt[3]{8}$ is a surd or not ?

$$\text{Let } \sqrt[3]{8} = p \quad p^3 = 8. \quad \text{Cube of which number is 8 ?}$$

We know 2 is cube-root of 8 or cube of 2 is 8.

$$\therefore \sqrt[3]{8} \text{ is not a surd.}$$

- (4) Whether $\sqrt[4]{8}$ is surd or not ?

Here $a = 8$, Order of surd $n = 4$; but 4^{th} root of 8 is not a rational number.

$$\therefore \sqrt[4]{8} \text{ is an irrational number. } \therefore \sqrt[4]{8} \text{ is a surd.}$$

This year we are going to study surds of order 2 only, means $\sqrt{3}$, $\sqrt{7}$, $\sqrt{42}$ etc.

The surds of order 2 is called **Quadratic surd**.

Simplest form of a surd

$$(i) \sqrt{48} = \sqrt{16 \times 3} = \sqrt{16} \times \sqrt{3} = 4\sqrt{3} \quad (ii) \sqrt{98} = \sqrt{49 \times 2} = \sqrt{49} \times \sqrt{2} = 7\sqrt{2}$$

$\sqrt{2}$, $\sqrt{3}$, $\sqrt{5}$, these type of surds are in the simplest form which cannot be simplified further.

Similar or like surds

$$\sqrt{2}, -3\sqrt{2}, \frac{4}{5}\sqrt{2} \text{ are some like surds.}$$

If p and q are rational numbers then $p\sqrt{a}$, $q\sqrt{a}$ are called like surds. Two surds are said to be like surds if their order is equal and radicands are equal.

$\sqrt{45}$ and $\sqrt{80}$ are the surds of order 2, so their order is equal but radicands are not same, Are these like surds? Let us simplify it as follows :

$$\sqrt{45} = \sqrt{9 \times 5} = \sqrt{9} \times \sqrt{5} = 3\sqrt{5} \quad \text{and} \quad \sqrt{80} = \sqrt{16 \times 5} = \sqrt{16} \times \sqrt{5} = 4\sqrt{5}$$

$\therefore 3\sqrt{5}$ and $4\sqrt{5}$ are now similar or like surds

means $\sqrt{45}$ and $\sqrt{80}$ are similar surds.



Remember this !

In the simplest form of the surds if order of the surds and radicand are equal then the surds are similar or like surds.



Let's learn.

Comparison of surds

Let a and b are two positive real numbers and

If $a < b$ then $a \times a < b \times a$

If $a^2 < ab$... (I) Similarly $ab < b^2$... (II)

$\therefore a^2 < b^2$... [from (I) and (II)]

But if $a > b$ then $a^2 > b^2$ and if $a = b$ then $a^2 = b^2$

hence if $a < b$ then $a^2 < b^2$

Here a and b both are real numbers so they may be rational numbers or surds. By using above properties, let us compare the surds.

(i) $6\sqrt{2}, 5\sqrt{5}$

$$\sqrt{36} \times \sqrt{2} \quad \boxed{?} \quad \sqrt{25} \times \sqrt{5}$$

$$\sqrt{72} \quad \boxed{?} \quad \sqrt{125}$$

But $72 \quad \boxed{<} \quad 125$

$$\therefore 6\sqrt{2} \quad \boxed{<} \quad 5\sqrt{5}$$

Or

$$(6\sqrt{2})^2 \quad \boxed{?} \quad (5\sqrt{5})^2,$$

$$72 < 125$$

$$\therefore 6\sqrt{2} \quad \boxed{<} \quad 5\sqrt{5}$$

(ii) $8\sqrt{3}, \sqrt{192}$

$$\sqrt{64} \times \sqrt{3} \quad \boxed{?} \quad \sqrt{192}$$

$$\sqrt{192} \quad \boxed{?} \quad \sqrt{192}$$

But $192 \quad \boxed{=} \quad 192$

$$\therefore \sqrt{192} \quad \boxed{=} \quad \sqrt{192}$$

$$\therefore 8\sqrt{3} \quad \boxed{=} \quad \sqrt{192}$$

(iii) $7\sqrt{2}, 5\sqrt{3}$

$$\sqrt{49} \times \sqrt{2} \quad \boxed{?} \quad \sqrt{25} \times \sqrt{3}$$

$$\sqrt{98} \quad \boxed{?} \quad \sqrt{75}$$

But $98 \quad \boxed{>} \quad 75$

$$\therefore 7\sqrt{2} \quad \boxed{>} \quad 5\sqrt{3}$$

Or

$$(7\sqrt{2})^2 \quad \boxed{?} \quad (5\sqrt{3})^2,$$

$$98 > 75$$

$$\therefore 7\sqrt{2} \quad \boxed{>} \quad 5\sqrt{3}$$

Operations on like surds

Mathematical operations like addition, subtraction, multiplication and division can be done on like surds.

Ex (1) Simplify : $7\sqrt{3} + 29\sqrt{3}$

Solution : $7\sqrt{3} + 29\sqrt{3} = (7 + 29)\sqrt{3} = 36\sqrt{3}$

Ex (2) Simplify : $7\sqrt{3} - 29\sqrt{3}$

Solution : $7\sqrt{3} - 29\sqrt{3} = (7 - 29)\sqrt{3} = -22\sqrt{3}$

Ex (3) Simplify : $13\sqrt{8} + \frac{1}{2}\sqrt{8} - 5\sqrt{8}$

Solution : $13\sqrt{8} + \frac{1}{2}\sqrt{8} - 5\sqrt{8} = (13 + \frac{1}{2} - 5)\sqrt{8} = (\frac{26+1-10}{2})\sqrt{8}$
 $= \frac{17}{2}\sqrt{8} = \frac{17}{2}\sqrt{4 \times 2}$
 $= \frac{17}{2} \times 2\sqrt{2} = 17\sqrt{2}$

Ex (4) Simplify : $8\sqrt{5} + \sqrt{20} - \sqrt{125}$

Solution : $8\sqrt{5} + \sqrt{20} - \sqrt{125} = 8\sqrt{5} + \sqrt{4 \times 5} - \sqrt{25 \times 5}$
 $= 8\sqrt{5} + 2\sqrt{5} - 5\sqrt{5}$
 $= (8 + 2 - 5)\sqrt{5}$
 $= 5\sqrt{5}$

Ex. (5) Multiply the surds $\sqrt{7} \times \sqrt{42}$.

Solution : $\sqrt{7} \times \sqrt{42} = \sqrt{7 \times 42} = \sqrt{7 \times 7 \times 6} = 7\sqrt{6}$ ($7\sqrt{6}$ is an irrational number.)

Ex. (6) Divide the surds : $\sqrt{125} \div \sqrt{5}$

Solution : $\frac{\sqrt{125}}{\sqrt{5}} = \sqrt{\frac{125}{5}} = \sqrt{25} = 5$ (5 is a rational number.)

Ex. (7) $\sqrt{50} \times \sqrt{18} = \sqrt{25 \times 2} \times \sqrt{9 \times 2} = 5\sqrt{2} \times 3\sqrt{2} = 15 \times 2 = 30$

Note that product and quotient of two surds may be rational numbers which can be observed in the above Ex. 6 and Ex. 7.



**Use your
brain power !**

$$\begin{aligned} \sqrt{9+16} &\stackrel{?}{=} \sqrt{9} + \sqrt{16} \\ \sqrt{100+36} &\stackrel{?}{=} \sqrt{100} + \sqrt{36} \end{aligned}$$

Rationalization of surd

If the product of two surds is a rational number, each surd is called a rationalizing factor of the other surd.

Ex. (1) If surd $\sqrt{2}$ is multiplied by $\sqrt{2}$ we get $\sqrt{2 \times 2} = \sqrt{4}$. $\sqrt{4} = 2$ is a rational number.

$\therefore \sqrt{2}$ is rationalizing factor of $\sqrt{2}$.

Ex. (2) Multiply $\sqrt{2} \times \sqrt{8}$

$$\sqrt{2} \times \sqrt{8} = \sqrt{16} = 4 \text{ is a rational number.}$$

$\therefore \sqrt{2}$ is the rationalizing factor of $\sqrt{8}$.

Similarly $8\sqrt{2}$ is also a rationalizing factor of $\sqrt{2}$.

because $\sqrt{2} \times 8\sqrt{2} = 8\sqrt{2} \times \sqrt{2} = 8 \times 2 = 16$.

$\sqrt{6}$, $\sqrt{16}$, $\sqrt{50}$ are the rationalizing factors of $\sqrt{2}$.



Remember this !

Rationalizing factor of a given surd is not unique. If a surd is a rationalizing factor of a given surd then a surd obtained by multiplying it with any non zero rational number is also a rationalizing factor of the given surd.

Ex. (3) Find the rationalizing factor of $\sqrt{27}$.

Solution : $\sqrt{27} = \sqrt{9 \times 3} = 3\sqrt{3}$ $\therefore 3\sqrt{3} \times \sqrt{3} = 3 \times 3 = 9$ is a rational number.

$\therefore \sqrt{3}$ is the rationalizing factor of $\sqrt{27}$.

Note that, $\sqrt{27} = 3\sqrt{3}$ means $3\sqrt{3} \times 3\sqrt{3} = 9 \times 3 = 27$.

Hence $3\sqrt{3}$ is also a rationalizing factor of $\sqrt{27}$. In the same way $4\sqrt{3}$, $7\sqrt{3}$, ... are also the rationalizing factors of $\sqrt{27}$. Out of all these $\sqrt{3}$ is the simplest rationalizing factor.

Ex. (4) Rationalize the denominator of $\frac{1}{\sqrt{5}}$.

Solution : $\frac{1}{\sqrt{5}} = \frac{1}{\sqrt{5}} \times \frac{\sqrt{5}}{\sqrt{5}} = \frac{\sqrt{5}}{5}$... (multiply numerator and denominator by $\sqrt{5}$.)

Ex. (5) Rationalize the denominator of $\frac{3}{2\sqrt{7}}$.

Solution : $\frac{3}{2\sqrt{7}} = \frac{3}{2\sqrt{7}} \times \frac{\sqrt{7}}{\sqrt{7}} = \frac{3\sqrt{7}}{2 \times 7} = \frac{3\sqrt{7}}{14}$
...(multiply $2\sqrt{7}$ by $\sqrt{7}$ is sufficient to rationalize.)

**Remember this !**

We can make use of rationalizing factor to rationalize the denominator.
It is easy to use the numbers with rational denominator, that is why we rationalize it.

Practice set 2.3

(1) State the order of the surds given below.

(i) $\sqrt[3]{7}$ (ii) $5\sqrt{12}$ (iii) $\sqrt[4]{10}$ (iv) $\sqrt{39}$ (v) $\sqrt[3]{18}$

(2) State which of the following are surds. Justify.

(i) $\sqrt[3]{51}$ (ii) $\sqrt[4]{16}$ (iii) $\sqrt[5]{81}$ (iv) $\sqrt{256}$ (v) $\sqrt[3]{64}$ (vi) $\sqrt{\frac{22}{7}}$

(3) Classify the given pair of surds into like surds and unlike surds.

(i) $\sqrt{52}$, $5\sqrt{13}$ (ii) $\sqrt{68}$, $5\sqrt{3}$ (iii) $4\sqrt{18}$, $7\sqrt{2}$
(iv) $19\sqrt{12}$, $6\sqrt{3}$ (v) $5\sqrt{22}$, $7\sqrt{33}$ (vi) $5\sqrt{5}$, $\sqrt{75}$

(4) Simplify the following surds.

(i) $\sqrt{27}$ (ii) $\sqrt{50}$ (iii) $\sqrt{250}$ (iv) $\sqrt{112}$ (v) $\sqrt{168}$

(5) Compare the following pair of surds.

(i) $7\sqrt{2}$, $5\sqrt{3}$ (ii) $\sqrt{247}$, $\sqrt{274}$ (iii) $2\sqrt{7}$, $\sqrt{28}$
(iv) $5\sqrt{5}$, $7\sqrt{2}$ (v) $4\sqrt{42}$, $9\sqrt{2}$ (vi) $5\sqrt{3}$, 9 (vii) 7 , $2\sqrt{5}$

(6) Simplify.

(i) $5\sqrt{3} + 8\sqrt{3}$ (ii) $9\sqrt{5} - 4\sqrt{5} + \sqrt{125}$
(iii) $7\sqrt{48} - \sqrt{27} - \sqrt{3}$ (iv) $\sqrt{7} - \frac{3}{5}\sqrt{7} + 2\sqrt{7}$

(7) Multiply and write the answer in the simplest form.

(i) $3\sqrt{12} \times \sqrt{18}$ (ii) $3\sqrt{12} \times 7\sqrt{15}$
(iii) $3\sqrt{8} \times \sqrt{5}$ (iv) $5\sqrt{8} \times 2\sqrt{8}$

(8) Divide, and write the answer in simplest form.

(i) $\sqrt{98} \div \sqrt{2}$ (ii) $\sqrt{125} \div \sqrt{50}$ (iii) $\sqrt{54} \div \sqrt{27}$ (iv) $\sqrt{310} \div \sqrt{5}$

(9) Rationalize the denominator.

(i) $\frac{3}{\sqrt{5}}$ (ii) $\frac{1}{\sqrt{14}}$ (iii) $\frac{5}{\sqrt{7}}$ (iv) $\frac{6}{9\sqrt{3}}$ (v) $\frac{11}{\sqrt{3}}$



Let's recall.

We know that,

$$\text{If } a > 0, b > 0 \text{ then } \sqrt{ab} = \sqrt{a} \times \sqrt{b}$$

$$(a+b)(a-b) = a^2 - b^2; \quad (\sqrt{a})^2 = a; \quad \sqrt{a^2} = a$$

Multiply.

Ex. (1) $\sqrt{2}(\sqrt{8} + \sqrt{18})$

$$= \sqrt{2 \times 8} + \sqrt{2 \times 18}$$

$$= \sqrt{16} + \sqrt{36}$$

$$= 4 + 6$$

$$= 10$$

Ex. (2) $(\sqrt{3} - \sqrt{2})(2\sqrt{3} - 3\sqrt{2})$

$$= \sqrt{3}(2\sqrt{3} - 3\sqrt{2}) - \sqrt{2}(2\sqrt{3} - 3\sqrt{2})$$

$$= \sqrt{3} \times 2\sqrt{3} - \sqrt{3} \times 3\sqrt{2} - \sqrt{2} \times 2\sqrt{3} + \sqrt{2} \times 3\sqrt{2}$$

$$= 2 \times 3 - 3\sqrt{6} - 2\sqrt{6} + 3 \times 2$$

$$= 6 - 5\sqrt{6} + 6$$

$$= 12 - 5\sqrt{6}$$



Let's learn.

Binomial quadratic surd

- $\sqrt{5} + \sqrt{3}; \frac{3}{4} + \sqrt{5}$ are the binomial quadratic surds form. $\sqrt{5} - \sqrt{3}; \frac{3}{4} - \sqrt{5}$ are also binomial quadratic surds.

Study the following examples.

- $(\sqrt{a} + \sqrt{b})(\sqrt{a} - \sqrt{b}) = (\sqrt{a})^2 - (\sqrt{b})^2 = a - b$
- $(\sqrt{5} + \sqrt{3})(\sqrt{5} - \sqrt{3}) = (\sqrt{5})^2 - (\sqrt{3})^2 = 5 - 3 = 2$
- $(\sqrt{3} + \sqrt{7})(\sqrt{3} - \sqrt{7}) = (\sqrt{3})^2 - (\sqrt{7})^2 = 3 - 7 = -4$
- $(\frac{3}{2} + \sqrt{5})(\frac{3}{2} - \sqrt{5}) = (\frac{3}{2})^2 - (\sqrt{5})^2 = \frac{9}{4} - 5 = \frac{9-20}{4} = -\frac{11}{4}$

The product of these two binomial surds $(\sqrt{5} + \sqrt{3})$ and $(\sqrt{5} - \sqrt{3})$ is a rational number, hence these are the conjugate pairs of each other.

Each binomial surds in the conjugate pair is the rationalizing factor for other.

Note that for $\sqrt{5} + \sqrt{3}$, the conjugate pair of binomial surd is $\sqrt{5} - \sqrt{3}$ or $\sqrt{3} - \sqrt{5}$.

Similarly for $7 + \sqrt{3}$, the conjugate pair is $7 - \sqrt{3}$ or $\sqrt{3} - 7$.



Remember this !

The product of conjugate pair of binomial surds is always a rational number.



Let's learn.

Rationalization of the denominator

The product of conjugate binomial surds is always a rational number - by using this property, the rationalization of the denominator in the form of binomial surd can be done.

Ex. (1) Rationalize the denominator $\frac{1}{\sqrt{5}-\sqrt{3}}$.

Solution : The conjugate pair of $\sqrt{5} - \sqrt{3}$ is $\sqrt{5} + \sqrt{3}$.

$$\frac{1}{\sqrt{5}-\sqrt{3}} = \frac{1}{\sqrt{5}-\sqrt{3}} \times \frac{\sqrt{5}+\sqrt{3}}{\sqrt{5}+\sqrt{3}} = \frac{\sqrt{5}+\sqrt{3}}{(\sqrt{5})^2-(\sqrt{3})^2} = \frac{\sqrt{5}+\sqrt{3}}{5-3} = \frac{\sqrt{5}+\sqrt{3}}{2}$$

Ex. (2) Rationalize the denominator $\frac{8}{3\sqrt{2}+\sqrt{5}}$.

Solution : The conjugate pair of $3\sqrt{2}+\sqrt{5}$ is $3\sqrt{2} - \sqrt{5}$

$$\begin{aligned} \frac{8}{3\sqrt{2}+\sqrt{5}} &= \frac{8}{3\sqrt{2}+\sqrt{5}} \times \frac{3\sqrt{2}-\sqrt{5}}{3\sqrt{2}-\sqrt{5}} \\ &= \frac{8(3\sqrt{2} - \sqrt{5})}{(3\sqrt{2})^2 - (\sqrt{5})^2} \\ &= \frac{8 \times 3\sqrt{2} - 8\sqrt{5}}{9 \times 2 - 5} = \frac{24\sqrt{2} - 8\sqrt{5}}{18 - 5} = \frac{24\sqrt{2} - 8\sqrt{5}}{13} \end{aligned}$$

Practice set 2.4

(1) Multiply.

(i) $\sqrt{3}(\sqrt{7} - \sqrt{3})$

(ii) $(\sqrt{5} - \sqrt{7})\sqrt{2}$

(iii) $(3\sqrt{2} - \sqrt{3})(4\sqrt{3} - \sqrt{2})$

(2) Rationalize the denominator.

(i) $\frac{1}{\sqrt{7}+\sqrt{2}}$

(ii) $\frac{3}{2\sqrt{5}-3\sqrt{2}}$

(iii) $\frac{4}{7+4\sqrt{3}}$

(iv) $\frac{\sqrt{5}-\sqrt{3}}{\sqrt{5}+\sqrt{3}}$



Let's learn.

Absolute value

If x is a real number then absolute value of x is its distance from zero on the number line which is written as $|x|$, and $|x|$ is read as Absolute Value of x or modulus of x .

If $x > 0$ then $|x| = x$ If x is positive then absolute value of x is x .

If $x = 0$ then $|x| = 0$ If x is zero then absolute value of x is zero.

If $x < 0$ then $|x| = -x$ If x is negative then its absolute value is opposite of x .

Ex. (1) $|3| = 3$, $|-3| = -(-3) = 3$, $|0| = 0$

The absolute value of any real number is never negative.

Ex. (2) Find the value.

(i) $|9-5| = |4| = 4$ (ii) $|8-13| = |-5| = 5$

(iii) $|8|-|-3| = 5$ (iv) $|8| \times |4| = 8 \times 4 = 32$

Ex. (3) Solve $|x - 5| = 2$.

Solution : $|x - 5| = 2$ $\therefore x - 5 = +2$ or $x - 5 = -2$
 $\therefore x = 2 + 5$ or $x = -2 + 5$
 $\therefore x = 7$ or $x = 3$

Practice set 2.5

(1) Find the value.

i) $|15 - 2|$ (ii) $|4 - 9|$ (iii) $|7| \times |-4|$

(2) Solve.

(i) $|3x-5|=1$ (ii) $|7-2x|=5$ (iii) $\left| \frac{8-x}{2} \right| = 5$ (iv) $\left| 5 + \frac{x}{4} \right| = 5$

Activity (I) : There are some real numbers written on a card sheet. Use these numbers and construct two examples each of addition, subtraction, multiplication and division. Solve these examples.

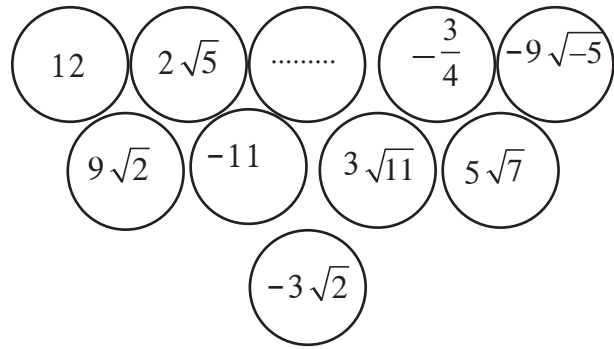

Activity (II) :

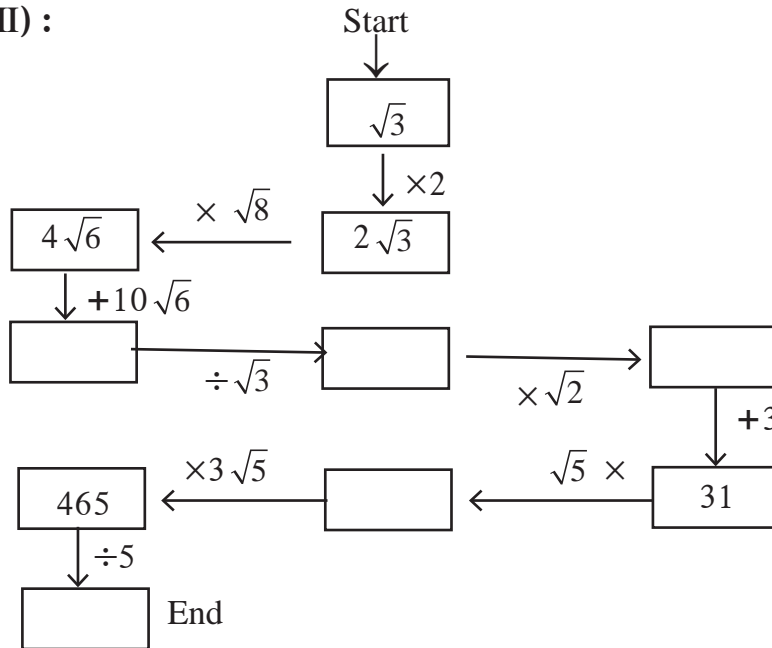

Problem set 2

(1) Choose the correct alternative answer for the questions given below.

- (i) Which one of the following is an irrational number ?
 (A) $\sqrt{\frac{16}{25}}$ (B) $\sqrt{5}$ (C) $\frac{3}{9}$ (D) $\sqrt{196}$
- (ii) Which of the following is an irrational number?
 (A) 0.17 (B) $1.\overline{513}$ (C) $0.27\overline{46}$ (D) 0.101001000.....
- (iii) Decimal expansion of which of the following is non-terminating recurring ?
 (A) $\frac{2}{5}$ (B) $\frac{3}{16}$ (C) $\frac{3}{11}$ (D) $\frac{137}{25}$
- (iv) Every point on the number line represent, which of the following numbers?
 (A) Natural numbers (B) Irrational numbers
 (C) Rational numbers (D) Real numbers
- (v) The number $0.\dot{4}$ in $\frac{p}{q}$ form is
 (A) $\frac{4}{9}$ (B) $\frac{40}{9}$ (C) $\frac{3.6}{9}$ (D) $\frac{36}{9}$

(vi) What is \sqrt{n} , if n is not a perfect square number ?

- (A) Natural number (B) Rational number
(C) Irrational number (D) Options A, B, C all are correct.

(vii) Which of the following is not a surd ?

- (A) $\sqrt{7}$ (B) $\sqrt[3]{17}$ (C) $\sqrt[3]{64}$ (D) $\sqrt{193}$

(viii) What is the order of the surd $\sqrt[3]{\sqrt{5}}$?

- (A) 3 (B) 2 (C) 6 (D) 5

(ix) Which one is the conjugate pair of $2\sqrt{5} + \sqrt{3}$?

- (A) $-2\sqrt{5} + \sqrt{3}$ (B) $-2\sqrt{5} - \sqrt{3}$ (C) $2\sqrt{3} - \sqrt{5}$ (D) $\sqrt{3} + 2\sqrt{5}$

(x) The value of $|12 - (13+7) \times 4|$ is

- (A) -68 (B) 68 (C) -32 (D) 32.

(2) Write the following numbers in $\frac{p}{q}$ form.

- (i) 0.555 (ii) $29.\overline{568}$ (iii) $9.315\ 315\ \dots$ (iv) $357.417417\dots$ (v) $30.\overline{219}$

(3) Write the following numbers in its decimal form.

- (i) $\frac{-5}{7}$ (ii) $\frac{9}{11}$ (iii) $\sqrt{5}$ (iv) $\frac{121}{13}$ (v) $\frac{29}{8}$

(4) Show that $5 + \sqrt{7}$ is an irrational number.

(5) Write the following surds in simplest form.

- (i) $\frac{3}{4}\sqrt{8}$ (ii) $-\frac{5}{9}\sqrt{45}$

(6) Write the simplest form of rationalising factor for the given surds.

- (i) $\sqrt{32}$ (ii) $\sqrt{50}$ (iii) $\sqrt{27}$ (iv) $\frac{3}{5}\sqrt{10}$ (v) $3\sqrt{72}$ (vi) $4\sqrt{11}$

(7) Simplify.

- (i) $\frac{4}{7}\sqrt{147} + \frac{3}{8}\sqrt{192} - \frac{1}{5}\sqrt{75}$ (ii) $5\sqrt{3} + 2\sqrt{27} + \frac{1}{\sqrt{3}}$ (iii) $\sqrt{216} - 5\sqrt{6} + \sqrt{294} - \frac{3}{\sqrt{6}}$

- (iv) $4\sqrt{12} - \sqrt{75} - 7\sqrt{48}$ (v*) $2\sqrt{48} - \sqrt{75} - \frac{1}{\sqrt{3}}$

(8) Rationalize the denominator.

- (i) $\frac{1}{\sqrt{5}}$ (ii) $\frac{2}{3\sqrt{7}}$ (iii) $\frac{1}{\sqrt{3}-\sqrt{2}}$ (iv) $\frac{1}{3\sqrt{5}+2\sqrt{2}}$ (v) $\frac{12}{4\sqrt{3}-\sqrt{2}}$



3

Polynomials



Let's study.

- Introduction to Polynomials
- Degree of the polynomial
- Value of the polynomial
- Operations on polynomials
- Synthetic Division
- Remainder theorem



Let's discuss.

$p^3 - \frac{1}{2}p^2 + p$; $m^2 + 2n^3 - \sqrt{3}m^5$; 6 are all algebraic expressions.

Teacher : Dear Students, consider each term of the expressions $p^3 - \frac{1}{2}p^2 + p$, $m^2 + 2n^3 - \sqrt{3}m^5$, 6 and state the power of each variable.

Madhuri : In the expressions $p^3 - \frac{1}{2}p^2 + p$ powers of p are 3, 2, 1 respectively.

Vivek : Sir, in the expression $m^2 + 2n^3 - \sqrt{3}m^5$ the powers of the variable are 2, 3, 5 respectively.

Rahul : Sir, apparently there is no variable in the expression 6. But $6 = 6 \times 1 = 6 \times x^0$. Therefore, the power of the variable is 0.

Teacher : In all algebraic expressions given above the powers of the variable are positive integers or zero. i.e. whole numbers.

In an algebraic expression, if the powers of the variables are whole numbers then that algebraic expression is known as **polynomial**. 6 is also a polynomial. 6, -7, $\frac{1}{2}$, 0, $\sqrt{3}$ etc. are constant numbers can be called as **Constant polynomial**. 0 is also a constant polynomial.

Are $\sqrt{y} + 5$ and $\frac{1}{y} - 3$ polynomials?

Sara : Sir, $\sqrt{y} + 5$ is not a polynomial, because $\sqrt{y} + 5 = y^{\frac{1}{2}} + 5$, here power of y is $\frac{1}{2}$ which is not a whole number.

John : Sir, $\frac{1}{y} - 3$ is also not a polynomial because $\frac{1}{y} - 3 = y^{-1} - 3$, here power of y is -1 which is not a whole number.

Teacher : Write any five algebraic expressions which are not polynomials.

Explain why these expressions are not polynomials ? Justify your answer.

- Is every algebraic expression a polynomial ?
- Is every polynomial an algebraic expression ?

Types of polynomials (based on number of terms)

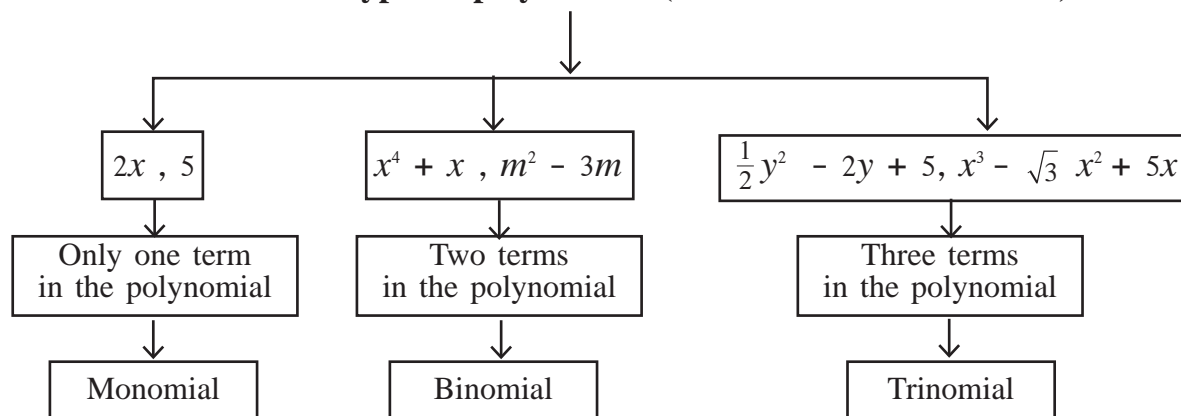

Polynomials are written as $p(x)$, $q(m)$, $r(y)$ according to the variable used.

For example, $p(x) = x^3 + 2x^2 + 5x - 3$, $q(m) = m^2 + \frac{1}{2}m - 7$, $r(y) = y^2 + 5$



Let's learn.

Degree of a polynomial in one variable

Teacher : In the polynomial $2x^7 - 5x + 9$ which is the highest power of the variable ?

Jija : Sir, the highest power is 7.

Teacher : In case of a polynomial in one variable, the highest power of the variable is called the **Degree of the polynomial**.

Now tell me, what is the degree of the given polynomial?

Ashok : Sir, the degree of the given polynomial $2x^7 - 5x + 9$ is 7.

Teacher : What is the degree of the polynomial 10 ?

Radha : $10 = 10 \times 1 = 10 \times x^0$ therefore the degree of the polynomial 10 is 0.

Teacher : Just like 10, **degree of any non zero constant polynomial is 0. Degree of zero polynomial is not defined.**

Degree of a polynomial in more than one variable

The highest sum of the powers of variables in each term of the polynomial is the degree of the polynomial.

Ex. $3m^3n^6 + 7m^2n^3 - mn$ is a polynomial in two variables m and n . Degree of the polynomial is 9. (as sum of the powers $3 + 6 = 9$, $2 + 3 = 5$, $1 + 1 = 2$)

Activity I : Write an example of a monomial, a binomial and a trinomial having variable x and degree 5.

Monomial

Binomial

Trinomial

Activity II : Give example of a binomial in two variables having degree 5.

Types of polynomial (based on degree)

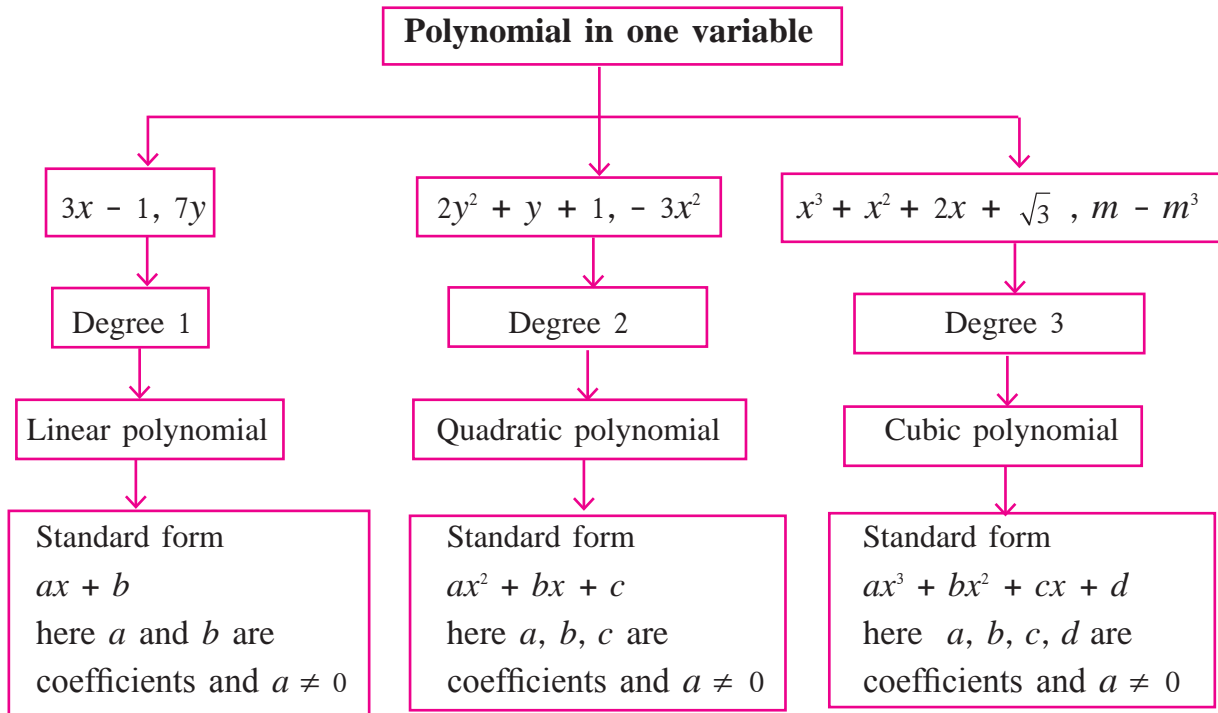

Polynomial : $a_n x^n + a_{n-1} x^{n-1} + \dots + a_2 x^2 + a_1 x + a_0$ is a polynomial in x with degree n

$a_n, a_{n-1}, \dots, a_2, a_1, a_0$ are the coefficients and $a_n \neq 0$

Standard form, coefficient form and index form of a polynomial

$p(x) = x - 3x^2 + 5 + x^4$ is a polynomial in x , which can be written in descending powers of its variable as $x^4 - 3x^2 + x + 5$. This is called the standard form of the polynomial. But in this polynomial there is no term having power 3 of the variable we can write it as $0x^3$. It can be added to the polynomial and it can be rewritten as $x^4 + 0x^3 - 3x^2 + x + 5$. This form of the polynomial is called **Index form** of the polynomial.

One can write the coefficients of the variables by considering all the missing terms in the standard form of the polynomial. For example : $x^3 - 3x^2 + 0x - 8$ can be written as $(1, -3, 0, -8)$. This form of the polynomial is called **Coefficient form**.

Polynomial $(4, 0, -5, 0, 1)$ can be written by using variable y as

$4y^4 + 0y^3 - 5y^2 + 0y + 1$. This form is called **Index form** of the polynomial.

Ex. $p(m) = 3m^5 - 7m + 5m^3 + 2$

Write the polynomial in standard form	$3m^5 + 5m^3 - 7m + 2$
Write it in the index form by considering all the missing terms with coefficient zero.	$3m^5 + 0m^4 + 5m^3 + 0m^2 - 7m + 2$
Write it in a coefficient form	$(3, 0, 5, 0, -7, 2)$
Degree of the polynomial	5

Ex (1) Write the polynomial $x^3 + 3x - 5$ in coefficient form.

Solution: $x^3 + 3x - 5 = x^3 + 0x^2 + 3x - 5$

\therefore given polynomial in coefficient form is $(1, 0, 3, -5)$

Ex (2) $(2, -1, 0, 5, 6)$ is the coefficient form of the polynomial. Represent it in index form.

Solution: Coefficient form of the polynomial is $(2, -1, 0, 5, 6)$

\therefore index form of the polynomial is $2x^4 - x^3 + 0x^2 + 5x + 6$ i.e. $2x^4 - x^3 + 5x + 6$

Practice set 3.1

1. State whether the given algebraic expressions are polynomials ? Justify.

- (i) $y + \frac{1}{y}$ (ii) $2 - 5\sqrt{x}$ (iii) $x^2 + 7x + 9$
 (iv) $2m^2 + 7m - 5$ (v) 10

2. Write the coefficient of m^3 in each of the given polynomial.

- (i) m^3 (ii) $\frac{-3}{2} + m - \sqrt{3}m^3$ (iii) $\frac{-2}{3}m^3 - 5m^2 + 7m - 1$

3. Write the polynomial in x using the given information.

- (i) Monomial with degree 7 (ii) Binomial with degree 35
 (iii) Trinomial with degree 8

4. Write the degree of the given polynomials.

- (i) $\sqrt{5}$ (ii) x° (iii) x^2 (iv) $\sqrt{2}m^{10} - 7$ (v) $2p - \sqrt{7}$
 (vi) $7y - y^3 + y^5$ (vii) $xyz + xy - z$ (viii) $m^3n^7 - 3m^5n + mn$

5. Classify the following polynomials as linear, quadratic and cubic polynomial.

- (i) $2x^2 + 3x + 1$ (ii) $5p$ (iii) $\sqrt{2}y - \frac{1}{2}$
 (iv) $m^3 + 7m^2 + \frac{5}{2}m - \sqrt{7}$ (v) a^2 (vi) $3r^3$

6. Write the following polynomials in standard form.

- (i) $m^3 + 3 + 5m$ (ii) $-7y + y^5 + 3y^3 - \frac{1}{2} + 2y^4 - y^2$

7. Write the following polynomials in coefficient form.

- (i) $x^3 - 2$ (ii) $5y$ (iii) $2m^4 - 3m^2 + 7$ (iv) $-\frac{2}{3}$

8. Write the polynomials in standard form.

- (i) (1, 2, 3) (ii) (5, 0, 0, 0, -1) (iii) (-2, 2, -2, 2)

9. Write the appropriate polynomials in the boxes.

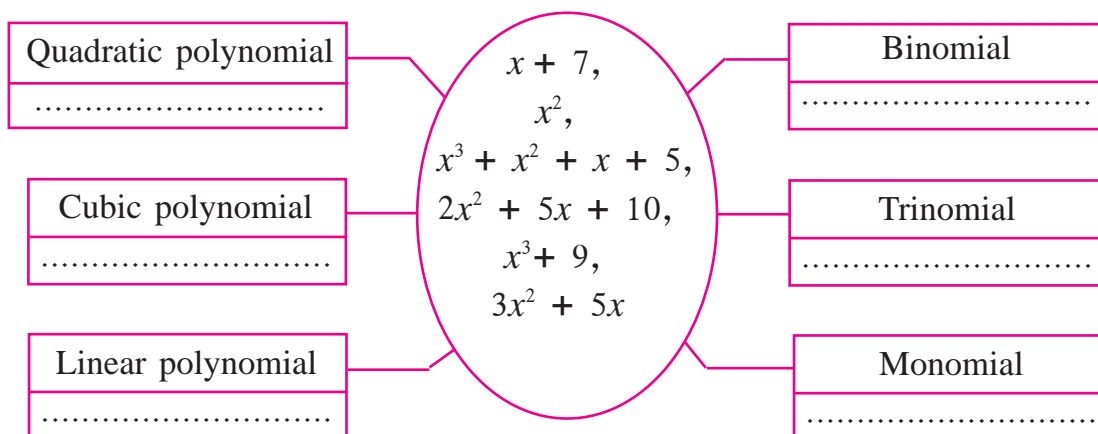

(1) Coefficients are added or subtracted while adding or subtracting like algebraic terms, e.g. $5m^3 - 7m^3 = (5 - 7)m^3 = -2m^3$

(2) While multiplying or dividing two algebraic terms, we multiply or divide their coefficients. We also use laws of indices.

$$-4y^3 \times 2y^2z = -8y^5z ; 12a^2b \div 3ab^2 = \frac{4a}{b}$$



Let's learn.

Operations on polynomials

The methods of addition, subtraction, multiplication and division of polynomials is similar to the operation of algebraic expressions.

Ex (1) Subtract : $5a^2 - 2a$ from $7a^2 + 5a + 6$.

$$\begin{aligned}
\text{Solution : } & (7a^2 + 5a + 6) - (5a^2 - 2a) \\
& = \underline{7a^2 + 5a + 6} - \underline{5a^2 + 2a} \\
& = 7a^2 - 5a^2 + 5a + 2a + 6 \\
& = 2a^2 + 7a + 6
\end{aligned}$$

Ex (2) Multiply : $-2a \times 5a^2$

$$\text{Solution : } -2a \times 5a^2 = -10a^3$$

Ex (3) Multiply : $(m^2 - 5) \times (m^3 + 2m - 2)$

$$\begin{aligned}
\text{Solution : } & (m^2 - 5) \times (m^3 + 2m - 2) \\
& = m^2(m^3 + 2m - 2) - 5(m^3 + 2m - 2) \\
& = m^5 + 2m^3 - 2m^2 - 5m^3 - 10m + 10 \\
& = m^5 + 2m^3 - 5m^3 - 2m^2 - 10m + 10 \quad (\text{Like terms taken together.}) \\
& = m^5 - 3m^3 - 2m^2 - 10m + 10
\end{aligned}$$

} (Each term of second polynomial is multiplied by each term of first polynomial.)

Here the degree of the product is 5.

Ex (4) Add : $3m^2n + 5mn^2 - 7mn$ and $2m^2n - mn^2 + mn$.

$$\begin{aligned}
\text{Solution : } & (3m^2n + 5mn^2 - 7mn) + (2m^2n - mn^2 + mn) \\
& = 3m^2n + 5mn^2 - 7mn + 2m^2n - mn^2 + mn \\
& = \underline{3m^2n + 2m^2n} + \underline{5mn^2 - mn^2} - \underline{7mn + mn} \quad (\text{Like terms are arranged.}) \\
& = 5m^2n + 4mn^2 - 6mn \quad (\text{Like terms are added.})
\end{aligned}$$



Let's recall.

Degree of one polynomial is 3 and the degree of other polynomials is 5. Then what is the degree of their product ?

What is the relation between degree of multiplicand and degree of a multiplier with degree of their product ?

Ex (5) Divide $(2 + 2x^2) \div (x + 2)$ and write the answer in the given form.

$$\text{Dividend} = \text{Divisor} \times \text{Quotient} + \text{Remainder}$$

Solution : Let us write the polynomial in standard form. $p(x) = 2 + 2x^2$

	$2 + 2x^2 = 2x^2 + 0x + 2$	
Method I :	$\begin{array}{r} 2x - 4 \\ x + 2 \overline{) 2x^2 + 0x + 2} \\ \underline{- 2x^2 + 4x} \\ - 4x + 2 \\ \underline{- 4x - 8} \\ + \\ \hline 10 \end{array}$	<p>Dividend = divisor \times quotient + remainder</p> <p>$2 + 2x^2 = (x + 2) \times (2x - 4) + 10$</p> <p>$q(x)$, divisor = $(x + 2)$</p> <p>$s(x)$, quotient = $2x - 4$ and</p> <p>$r(x)$, remainder = 10</p> <p>$\therefore p(x) = q(x) \times s(x) + r(x)$.</p>

Method II : Linear method of division :

Divide $(2x^2 + 2) \div (x + 2)$

To get the term $2x^2$ multiply $(x + 2)$ by $2x$ and subtract $4x$.

$$2x(x+2) - 4x = 2x^2$$

$$\therefore \text{Dividend} = 2x^2 + 2 = 2x(x+2) - 4x + 2 \quad \dots(I)$$

To get the term $-4x$ multiply $(x+2)$ by -4 and add 8.

$$-4(x+2) + 8 = -4x$$

$$\therefore (2x^2 + 2) = 2x(x+2) - 4(x+2) + 8 + 2 \quad \dots\text{from (I)}$$

$$\therefore (2x^2 + 2) = (x + 2) (2x - 4) + 10$$

Dividend = divisor \times quotient + remainder.



Remember this !

Euclid's division lemma

If $s(x)$ and $p(x)$ are two polynomials such that degree of $s(x)$ is greater than or equal to the degree of $p(x)$ and after dividing $s(x)$ by $p(x)$ the quotient is $q(x)$ then $s(x) = p(x) \times q(x) + r(x)$, where $r(x) = 0$ or degree of $r(x) < 0$.

Practice set 3.2

- (1) Use the given letters to write the answer.
 - (i) There are 'a' trees in the village Lat. If the number of trees increases every year by 'b', then how many trees will there be after 'x' years?
 - (ii) For the parade there are y students in each row and x such row are formed. Then, how many students are there for the parade in all ?
 - (iii) The tens and units place of a two digit number is m and n respectively. Write the polynomial which represents the two digit number.
- (2) Add the given polynomials.
 - (i) $x^3 - 2x^2 - 9$; $5x^3 + 2x + 9$
 - (ii) $-7m^4 + 5m^3 + \sqrt{2}$; $5m^4 - 3m^3 + 2m^2 + 3m - 6$
 - (iii) $2y^2 + 7y + 5$; $3y + 9$; $3y^2 - 4y - 3$
- (3) Subtract the second polynomial from the first.
 - (i) $x^2 - 9x + \sqrt{3}$; $-19x + \sqrt{3} + 7x^2$
 - (ii) $2ab^2 + 3a^2b - 4ab$; $3ab - 8ab^2 + 2a^2b$
- (4) Multiply the given polynomials.
 - (i) $2x$; $x^2 - 2x - 1$ (ii) $x^5 - 1$; $x^3 + 2x^2 + 2$ (iii) $2y + 1$; $y^2 - 2y^3 + 3y$
- (5) Divide first polynomial by second polynomial and write the answer in the form 'Dividend = Divisor \times Quotient + Remainder'.
 - (i) $x^3 - 64$; $x - 4$ (ii) $5x^5 + 4x^4 - 3x^3 + 2x^2 + 2$; $x^2 - x$
- (6*) Write down the information in the form of algebraic expression and simplify.

There is a rectangular farm with length $(2a^2 + 3b^2)$ metre and breadth $(a^2 + b^2)$ metre. The farmer used a square shaped plot of the farm to build a house. The side of the plot was $(a^2 - b^2)$ metre. What is the area of the remaining part of the farm ?

Activity : Read the following passage, write the appropriate amount in the boxes and discuss.

Govind, who is a dry land farmer from Shiralas has a 5 acre field. His family includes his wife, two children and his old mother. He borrowed one lakh twenty five thousand rupees from the bank for one year as agricultural loan at 10 p.c.p.a. He cultivated soyabean in x acres and cotton and tur in y acres. The expenditure he incurred was as follows :

He spent Rs. 10,000 on seeds. The expenses for fertilizers and pesticides for the soyabean crop was $2000x$ rupees and $4000x^2$ rupees were spent on wages and cultivation of land. He spent $8000y$ rupees on fertilizers and pesticides and rupees $9000y^2$ for wages and cultivation of land for the cotton and tur crops.

Let us write the total expenditure on all the crops by using variables x and y .

$$\boxed{} + \boxed{2000x} + \boxed{4000x^2} + \boxed{8000y} + \boxed{} \text{ rupees}$$

He harvested $5x^2$ quintals soyabean and sold it at Rs. 2800 per quintal. The cotton crop yield was $\frac{5}{3}y^2$ quintals which fetched Rs. 5000 per quintal. The tur crop yield was $4y$ quintals and was sold at Rs. 4000 per quintal. Let us write the total income in rupees that was obtained by selling the entire farm produce, with the help of an expression using variables x and y .

$$\boxed{} + \boxed{} + \boxed{} \text{ rupees}$$



Let's learn.

Synthetic division

We know, how to divide one polynomial by other polynomial. Now we will learn an easy method for division of polynomials when divisor is of the form $x + a$ or $x - a$.

Ex (1) Divide the polynomial $(3x^3 + 2x^2 - 1)$ by $(x + 2)$.

Solution : Let us write the dividend polynomial in the coefficient form.

Index form of the dividend polynomial is $3x^3 + 2x^2 - 1 = 3x^3 + 2x^2 + 0x - 1$

\therefore coefficient form of the given polynomial = $(3, 2, 0, -1)$

Divisor polynomial = $x + 2$

Let us use the following steps for synthetic division.

(1) Draw one horizontal and one vertical line as shown alongside.

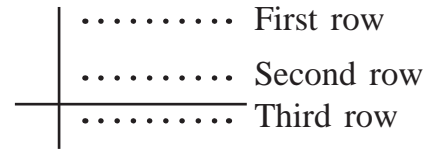

(2) Divisor is $x + 2$. Hence take opposite number of 2 which is -2

Write -2 to the left of the vertical line as shown. Write the coefficient form of the dividend polynomial in the first row.

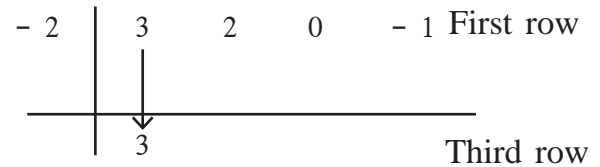

(3) Write the first coefficient as it is in the third row.

(4) The product of 3 in the third row with divisor -2 is -6 . Write this -6 in the second row below the coefficient 2.

Addition of 2 and -6 which is -4 , is to be written in the third row.

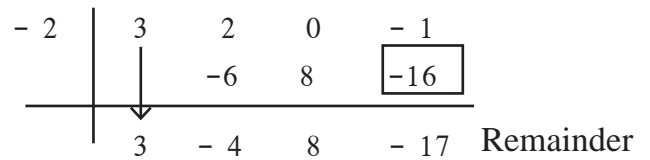

Similarly by multiplying and adding, last addition is the remainder, which is (-17) and coefficient form of the Quotient is $(3, -4, 8)$.

$$\therefore \text{Quotient} = 3x^2 - 4x + 8 \text{ and } \text{Remainder} = -17$$

$$\therefore 3x^3 + 2x^2 - 1 = (x + 2)(3x^2 - 4x + 8) - 17$$

This method is called the **method of synthetic division**. The same division can be done by linear method of division as shown below.

$$\begin{aligned} 3x^3 + 2x^2 - 1 &= 3x^2(x + 2) - 6x^2 + 2x^2 - 1 \\ &= 3x^2(x + 2) - 4x^2 - 1 \\ &= 3x^2(x + 2) - 4x^2 - 8x + 8x - 1 \\ &= 3x^2(x + 2) - 4x(x + 2) + 8x - 1 \\ &= 3x^2(x + 2) - 4x(x + 2) + 8x + 16 - 16 - 1 \\ &= 3x^2(x + 2) - 4x(x + 2) + 8(x + 2) - 17 \end{aligned}$$

$$\therefore 3x^3 + 2x^2 - 1 = (x + 2)(3x^2 - 4x + 8) - 17$$

Ex (2) Divide $(2y^4 - 3y^3 + 5y - 4) \div (y - 1)$

Solution : Synthetic division : Dividend = $2y^4 - 3y^3 + 5y - 4 = 2y^4 - 3y^3 + 0y^2 + 5y - 4$

Divisor = $y - 1$ Opposite of -1 is 1 .

1	2	- 3	0	5	- 4	
		2	- 1	- 1	4	
	2	- 1	- 1	4	0	Remainder

Coefficient form of the quotient is $(2, -1, -1, 4)$.

\therefore Quotient = $2y^3 - y^2 - y + 4$ and Remainder = 0

Linear method : $2y^4 - 3y^3 + 5y - 4 = 2y^3(y - 1) + 2y^3 - 3y^3 + 5y - 4$

$$= 2y^3(y - 1) - y^2(y - 1) - y^2 + 5y - 4$$

$$= 2y^3(y - 1) - y^2(y - 1) - y(y - 1) + 4y - 4$$

$$= (2y^3 - y^2 - y + 4)(y - 1)$$



Remember this !

In the division by synthetic method the divisor polynomial is in the form $x + a$ or $x - a$ whose degree is 1 .

Practice set 3.3

1. Divide each of the following polynomials by synthetic division method and also by linear division method. Write the quotient and the remainder.

(i) $(2m^2 - 3m + 10) \div (m - 5)$

(ii) $(x^4 + 2x^3 + 3x^2 + 4x + 5) \div (x + 2)$

(iii) $(y^3 - 216) \div (y - 6)$

(iv) $(2x^4 + 3x^3 + 4x - 2x^2) \div (x + 3)$

(v) $(x^4 - 3x^2 - 8) \div (x + 4)$

(vi) $(y^3 - 3y^2 + 5y - 1) \div (y - 1)$



Let's learn.

Value of a polynomial

In a polynomial if variable is replaced by a number then we get the value of that polynomial. For example if we replace x by 2 in the polynomial $x + 7$ we get $2 + 7 = 9$ which is the value of that polynomial.

If $p(x)$ is a polynomial in x then the value of the polynomial for $x = a$ is written as $p(a)$.

Ex (1) Find the value of the polynomial $p(x) = 2x^2 - 3x + 5$ for $x = 2$.

Solution : Polynomial $p(x) = 2x^2 - 3x + 5$

Put $x = 2$ in the given polynomial,

$$\begin{aligned}\therefore p(2) &= 2 \times 2^2 - 3 \times 2 + 5 \\ &= 2 \times 4 - 6 + 5 \\ &= 8 - 6 + 5 \\ \therefore p(2) &= 7\end{aligned}$$

Ex (2) Find the value of $p(y) = 2y^3 - 2y + \sqrt{7}$ for $y = -2$

Solution : $p(y) = 2y^3 - 2y + \sqrt{7}$

$$\begin{aligned}\therefore p(-2) &= 2 \times (-2)^3 - 2 \times (-2) + \sqrt{7} \\ &= 2 \times (-8) - 2 \times (-2) + \sqrt{7} \\ &= -16 + 4 + \sqrt{7} \\ &= -12 + \sqrt{7}\end{aligned}$$

\therefore For $y = -2$ the value of polynomial is $-12 + \sqrt{7}$.

Ex (3) If $p(x) = 2x^2 - x^3 + x + 2$ then find $p(0)$.

Solution : $p(x) = 2x^2 - x^3 + x + 2$

$$\begin{aligned}\therefore p(0) &= 2 \times 0^2 - 0^3 + 0 + 2 \\ &= 2 \times 0 - 0 + 0 + 2 \\ &= 2\end{aligned}$$

Ex (4) If the value of the polynomial $m^2 - am + 7$ for $m = -1$ is 10, then find the value of a .

Solution : $p(m) = m^2 - am + 7$

$$\begin{aligned}\therefore p(-1) &= (-1)^2 - a \times (-1) + 7 \\ &= 1 + a + 7 \\ &= 8 + a\end{aligned}$$

But $p(-1) = 10$ (given.)

$$\begin{aligned}\therefore 8 + a &= 10 \\ \therefore a &= 10 - 8 \\ \therefore a &= 2\end{aligned}$$

Practice set 3.4

- (1) For $x = 0$ find the value of the polynomial $x^2 - 5x + 5$.
- (2) If $p(y) = y^2 - 3\sqrt{2}y + 1$ then find $p(3\sqrt{2})$.
- (3) If $p(m) = m^3 + 2m^2 - m + 10$ then $p(a) + p(-a) = ?$
- (4) If $p(y) = 2y^3 - 6y^2 - 5y + 7$ then find $p(2)$.



Remember this !

To find the value of a polynomial for a given value of the variable put the value in place of the variable in each term of the polynomial.



Let's learn.

Remainder Theorem

There is a relation between the value of $p(x)$ for $x = -(a \times 1)$ that is $p(-a)$, and the remainder when $p(x)$ is divided by $(x + a)$.

To understand this relation let's learn the following example .

Ex. Divide $p(x) = (4x^2 - x + 2)$ by $(x + 1)$

[Note that here $(x + a)$ is $(x + 1)$]

Solution :

Dividend polynomial = $4x^2 - x + 2$

Divisor polynomial = $x + 1$

$$\begin{array}{r}
 \begin{array}{r}
 4x - 5 \quad \text{Division} \\
 \hline
 \text{Divisor } x + 1 \overline{) 4x^2 - x + 2} \quad \text{Dividend} \\
 \underline{- 4x^2 + 4x} \\
 - 5x + 2 \\
 \underline{- 5x - 5} \\
 + 7 \\
 \hline
 7 \text{ Remainder}
 \end{array}
 \end{array}$$

Quotient = $4x - 5$ Remainder = 7 (I)

Let's divide by synthetic method.

Coefficient form of $p(x)$ is $(4, -1, 2)$

Divisor polynomial = $x + 1$

Opposite of 1 is -1

$$\begin{array}{r|rrr}
 -1 & 4 & -1 & 2 \\
 & & -4 & 5 \\
 \hline
 & 4 & -5 & \boxed{7} \text{ Remainder}
 \end{array}$$

Quotient = $4x - 5$ Remainder = 7

Now we will find the relation between remainder and value of the polynomial as follows:

In the dividend polynomial $4x^2 - x + 2$ put $x = -1$.

$$p(x) = 4x^2 - x + 2$$

$$\begin{aligned} \therefore p(-1) &= 4 \times (-1)^2 - (-1) + 2 \\ &= 4 \times 1 + 1 + 2 \\ &= 4 + 1 + 2 \\ &= 7 \end{aligned}$$

\therefore value of the polynomial $p(x)$ for $x = -1$ is 7. (II)

From the statement (I) and (II), the remainder when $p(x) = 4x^2 - x + 2$ is divided by $(x + a)$ that is $x + 1$ and the value of the polynomial $p(x)$ for $x = -1$, that is $p(-1)$, both are equal.

Hence we get the following property.

If the polynomial $p(x)$ is divided by $(x + a)$ then the **remainder** is $p(-a)$ means it is same as the **value of the polynomial** $p(x)$ for $x = -a$

This is known as the **Remainder theorem**.

Let's prove the theorem using Euclid's division lemma.

If $p(x)$ is divided by $(x + a)$

$$p(x) = q(x) \times (x + a) + r(x) \quad [q(x) = \text{Quotient}, r(x) = \text{Remainder}]$$

If, $r(x) \neq 0$, then by rule the degree of the polynomial $r(x)$ is less than 1 means 0. Therefore $r(x)$ is a real number.

$\therefore r(-a)$ is also a real number.

$$\text{Now, } p(x) = q(x) \times (x + a) + r(x) \text{(I)}$$

By putting $x = -a$ in (I) we get,

$$\begin{aligned} p(-a) &= q(-a) \times (a - a) + r(-a) \\ &= q(-a) \times 0 + r(-a) \text{(II)} \\ \therefore p(-a) &= r(-a) \text{from (I) and (II)} \end{aligned}$$

Activity : Verify the following examples.

- (1) Divide $p(x) = 3x^2 + x + 7$ by $x + 2$. Find the Remainder.
- (2) Find the value of $p(x) = 3x^2 + x + 7$ when $x = -2$.
- (3) See whether remainder obtained by division is same as the value of $p(-2)$. Take one more example and verify.

Ex (1) Divide $x^4 - 5x^2 - 4x$ by $x + 3$ and find the remainder.

Solution : By Remainder Theorem

Dividend polynomial $p(x) = x^4 - 5x^2 - 4x$

Divisor = $x + 3$

take $x = -3$.

$$\therefore p(x) = x^4 - 5x^2 - 4x$$

$$p(-3) = (-3)^4 - 5(-3)^2 - 4(-3)$$

$$= 81 - 45 + 12$$

$$p(-3) = 48$$

By Synthetic Divison

Index form $x^4 + 0x^3 - 5x^2 - 4x + 0$

Coefficient form = $(1, 0, -5, -4, 0)$

- 3	1	0	-5	-4	0
		-3	9	-12	48
	1	-3	4	-16	48

Remainder = 48

Ex (2) By using remainder theorem divide the polynomial $x^3 - 2x^2 - 4x - 1$ by $x - 1$ and find the remainder.

Solution : $p(x) = x^3 - 2x^2 - 4x - 1$

Divisor = $x - 1$ \therefore take $x = 1$

$$\therefore \text{Remainder} = p(1) = 1^3 - 2 \times 1^2 - 4 \times 1 - 1 \quad \dots(\text{by remainder theorem})$$

$$= 1 - 2 \times 1 - 4 - 1$$

$$p(1) = 1 - 2 - 4 - 1 = -6$$

$$\therefore \text{Remainder} = -6$$

Ex (3) If the polynomial $t^3 - 3t^2 + kt + 50$ is divided by $(t-3)$, the remainder is 62. Find the value of k .

Solution : When given polynomial is divided by $(t-3)$ the remainder is 62. It means the value of the polynomial when $t = 3$ is 62.

$$p(t) = t^3 - 3t^2 + kt + 50$$

By remainder theorem,

$$\begin{aligned}\text{Remainder} &= p(3) = 3^3 - 3 \times 3^2 + k \times 3 + 50 \\ &= 27 - 3 \times 9 + 3k + 50 \\ &= 27 - 27 + 3k + 50 \\ &= 3k + 50\end{aligned}$$

But remainder is 62.

$$\therefore 3k + 50 = 62$$

$$\therefore 3k = 62 - 50$$

$$\therefore 3k = 12$$

$$\therefore k = \frac{12}{3}$$

$$\therefore k = 4$$



Remember this !

If a polynomial $p(x)$ is divided by $(x + a)$ then the remainder is $p(-a)$ where 'a' is a real number.

$$p(x) = s(x) \times (x - a) + r(x) \text{ where degree of } r(x) < 1 \text{ or } r(x) = 0$$

In this equation by putting $x = a$ we get, $p(a) = 0 + r(a) = r(a)$.

Hence if $r(a) = 0$ means $(x - a)$ is a factor of $p(x)$.



Let's learn.

Factor Theorem

If 21 is divided by 7 then remainder is 0, therefore we say that 7 is a factor of 21. In the same way when a given polynomial is divided by the divisor polynomial and if the remainder is 0 then we say that divisor polynomial is the factor of the dividend polynomial.

Ex (1) If $p(x) = (x^3 + 4x - 5)$ is divided by $(x - 1)$ then find the remainder and hence determine whether $(x - 1)$ is a factor of $p(x)$ or not ?

$$\begin{aligned}\text{Solution : } p(x) &= x^3 + 4x - 5 \\ p(1) &= (1)^3 + 4(1) - 5 \\ &= 1 + 4 - 5 \\ &= 0\end{aligned}$$

As per the remainder theorem,

$$\text{Remainder} = 0$$

$\therefore (x - 1)$ is a factor of $p(x)$.

Ex (2) If $p(x) = x^3 + 4x - 5$ is divided by $x + 2$ then find the remainder and hence determine whether $(x + 2)$ is a factor of $p(x)$ or not.

$$\begin{aligned}\text{Solution : } p(x) &= x^3 + 4x - 5 \\ p(-2) &= (-2)^3 + 4(-2) - 5 \\ p(-2) &= -8 - 8 - 5 \\ &= -21\end{aligned}$$

As per the remainder theorem,

$$\text{Remainder} = -21 \therefore \text{Remainder} \neq 0$$

$\therefore (x + 2)$ is not a factor of $p(x)$.

Activity : Verify that $(x - 1)$ is a factor of the polynomial $x^3 + 4x - 5$.



Remember this !

$p(x)$ is a polynomial and a is any real number, and if $p(a) = 0$ then $(x - a)$ is the factor of $p(x)$.

Conversely if $(x - a)$ is the factor of the polynomial $p(x)$ then $p(a) = 0$.

Ex (1) Check whether, $x - 2$ is a factor of the polynomial $x^3 - x^2 - 4$ by using factor theorem.

Solution : $p(x) = x^3 - x^2 - 4$ Divisor = $x - 2$

$$\therefore p(2) = 2^3 - 2^2 - 4 = 8 - 4 - 4 = 0$$

\therefore By factor theorem $(x - 2)$ is a factor of the polynomial $(x^3 - x^2 - 4)$.

Ex (2) If $(x - 1)$ is the factor of the polynomial $(x^3 - 2x^2 + mx - 4)$ then find the value of m .

Solution : $(x - 1)$ is factor of $p(x)$. $\therefore p(1) = 0$

$$p(x) = x^3 - 2x^2 + mx - 4$$

$$p(1) = 1^3 - 2 \times 1^2 + m \times 1 - 4 = 0$$

$$\therefore 1 - 2 \times 1 + m - 4 = 0$$

$$\therefore 1 - 2 + m - 4 = 0 \quad \therefore m - 5 = 0 \quad \therefore m = 5$$

Activity : We have seen the example of expenditure and income (in terms of polynomials) of Govind who is a dry land farmer. He has borrowed rupees one lakh twenty, five thousand from the bank as an agriculture loan and repaid the said loan at 10 p.c.p.a. He had spent ₹ 10,000 on seeds. The expenses on soyabean crop was ₹ 2000x for fertilizers and pesticides and ₹ 4000x² was spent on wages and cultivation. He spent ₹ 8000y on fertilizers and pesticides and ₹ 9000y² on cultivation and wages for cotton and tur crop.

His total income was rupees $14000x^2 + \frac{25000}{3}y^2 + 16000y$.

By taking $x = 2, y = 3$ write the income-expenditure account of Govind's farming.

Solution : **Credit (Income)**

Debit (Expenses)

₹ 1,25,000	Bank loan	₹ 1,37,000	loan paid with interest for seeds
₹ <input type="text"/>	Income from soyabean	₹ <input type="text"/>	For seeds
₹ <input type="text"/>	Income from cotton	₹ <input type="text"/>	Fertilizers and pesticides for soyabean
₹ <input type="text"/>	Income from tur	₹ <input type="text"/>	Wages and cultivation charges for soyabean
₹ <input type="text"/>	Total income	₹ <input type="text"/>	Fertilizers and pesticides for cotton & tur
		₹ <input type="text"/>	Wages and cultivation charges for cotton & tur
		₹ <input type="text"/>	Total expenditure

Practice set 3.5

- (1) Find the value of the polynomial $2x - 2x^3 + 7$ using given values for x .
- (i) $x = 3$ (ii) $x = -1$ (iii) $x = 0$
- (2) For each of the following polynomial, find $p(1)$, $p(0)$ and $p(-2)$.
- (i) $p(x) = x^3$ (ii) $p(y) = y^2 - 2y + 5$ (iii) $p(x) = x^4 - 2x^2 - x$
- (3) If the value of the polynomial $m^3 + 2m + a$ is 12 for $m = 2$, then find the value of a .
- (4) For the polynomial $mx^2 - 2x + 3$ if $p(-1) = 7$ then find m .
- (5) Divide the first polynomial by the second polynomial and find the remainder using remainder theorem.
- (i) $(x^2 - 7x + 9) ; (x + 1)$ (ii) $(2x^3 - 2x^2 + ax - a) ; (x - a)$
 (iii) $(54m^3 + 18m^2 - 27m + 5) ; (m - 3)$
- (6) If the polynomial $y^3 - 5y^2 + 7y + m$ is divided by $y + 2$ and the remainder is 50 then find the value of m .
- (7) Use factor theorem to determine whether $x + 3$ is factor of $x^2 + 2x - 3$ or not.
- (8) If $(x - 2)$ is a factor of $x^3 - mx^2 + 10x - 20$ then find the value of m .
- (9) By using factor theorem in the following examples, determine whether $q(x)$ is a factor $p(x)$ or not.
- (i) $p(x) = x^3 - x^2 - x - 1$, $q(x) = x - 1$
 (ii) $p(x) = 2x^3 - x^2 - 45$, $q(x) = x - 3$
- (10) If $(x^{31} + 31)$ is divided by $(x + 1)$ then find the remainder.
- (11) Show that $m - 1$ is a factor of $m^{21} - 1$ and $m^{22} - 1$.
- (12*) If $x - 2$ and $x - \frac{1}{2}$ both are the factors of the polynomial $nx^2 - 5x + m$, then show that $m = n = 2$
- (13) (i) If $p(x) = 2 + 5x$ then $p(2) + p(-2) - p(1)$.
 (ii) If $p(x) = 2x^2 - 5\sqrt{3}x + 5$ then $p(5\sqrt{3})$.



Let's recall.

In previous classes we have learnt how to find the factors of the polynomials. Let's revise it with some examples.

Factorize.

Ex (1) $4x^2 - 25$
 $= (2x)^2 - (5)^2$
 $= (2x + 5)(2x - 5)$

Ex (2) $3x^2 + 7x + 2$
 $= \frac{3x^2 + 6x + x + 2}{3x(x + 2) + 1(x + 2)}$
 $= (x + 2)(3x + 1)$

$$\begin{aligned}
 \text{Ex (3)} \quad & 63x^2 + 5x - 2 \\
 &= 63x^2 + 14x - 9x - 2 \\
 &= 7x(9x + 2) - 1(9x + 2) \\
 &= (9x + 2)(7x - 1)
 \end{aligned}$$

$$\begin{aligned}
 \text{Ex (4)} \quad & 6x^2 - 5x - 6 \\
 &= 6x^2 - 9x + 4x - 6 \\
 &= 3x(2x - 3) + 2(2x - 3) \\
 &= (2x - 3)(3x + 2)
 \end{aligned}$$



Let's learn.

Factors of polynomials

Sometimes polynomial can be written in the form $ax^2 + bx + c$ and hence it is easy to find its factors.

Ex (1) Factorise : $(y^2-3y)^2 - 5(y^2-3y) - 50$.

Solution : Let $(y^2-3y) = x$

$$\begin{aligned}
 \therefore (y^2-3y)^2 - 5(y^2-3y) - 50 &= x^2 - 5x - 50 \\
 &= x^2 - 10x + 5x - 50 \\
 &= x(x - 10) + 5(x - 10) \\
 &= (x - 10)(x + 5) \\
 &= (y^2-3y - 10)(y^2-3y + 5) \\
 &= [y^2-5y + 2y - 10](y^2-3y + 5) \\
 &= [y(y - 5) + 2(y - 5)](y^2-3y + 5) \\
 &= (y - 5)(y + 2)(y^2-3y + 5)
 \end{aligned}$$

Ex (2) Factorise.

$$(x + 2)(x - 3)(x - 7)(x - 2) + 64$$

$$\begin{aligned}
 \text{Solution : } & (x + 2)(x - 3)(x - 7)(x - 2) + 64 \\
 &= (x + 2)(x - 7)(x - 3)(x - 2) + 64 \\
 &= (x^2 - 5x - 14)(x^2 - 5x + 6) + 64 \\
 &= (m - 14)(m + 6) + 64 \dots \dots \dots \text{ (putting } x^2 - 5x = m) \\
 &= m^2 - 14m + 6m - 84 + 64 \\
 &= m^2 - 8m - 20 \\
 &= (m - 10)(m + 2) \\
 &= (x^2 - 5x - 10)(x^2 - 5x + 2) \quad \dots \text{ (replace } m \text{ with } x^2 - 5x)
 \end{aligned}$$

Practice set 3.6

(1) Find the factors of the polynomials given below.

(i) $2x^2 + x - 1$

(ii) $2m^2 + 5m - 3$

(iii) $12x^2 + 61x + 77$

(iv) $3y^2 - 2y - 1$

(v) $\sqrt{3}x^2 + 4x + \sqrt{3}$

(vi) $\frac{1}{2}x^2 - 3x + 4$

(2) Factorize the following polynomials.

(i) $(x^2 - x)^2 - 8(x^2 - x) + 12$

(ii) $(x - 5)^2 - (5x - 25) - 24$

(iii) $(x^2 - 6x)^2 - 8(x^2 - 6x + 8) - 64$

(iv) $(x^2 - 2x + 3)(x^2 - 2x + 5) - 35$

(v) $(y + 2)(y - 3)(y + 8)(y + 3) + 56$

(vi) $(y^2 + 5y)(y^2 + 5y - 2) - 24$

(vii) $(x - 3)(x - 4)^2(x - 5) - 6$

Problem set 3

(1) Write the correct alternative answer for each of the following questions.

(i) Which of the following is a polynomial ?

(A) $\frac{x}{y}$

(B) $x^{\sqrt{2}} - 3x$

(C) $x^{-2} + 7$

(D) $\sqrt{2}x^2 + \frac{1}{2}$

(ii) What is the degree of the polynomial $\sqrt{7}$?

(A) $\frac{1}{2}$

(B) 5

(C) 2

(D) 0

(iii) What is the degree of the 0 polynomial ?

(A) 0

(B) 1

(C) undefined

(D) any real number

(iv) What is the degree of the polynomial $2x^2 + 5x^3 + 7$?

(A) 3

(B) 2

(C) 5

(D) 7

(v) What is the coefficient form of $x^3 - 1$?

(A) (1, - 1)

(B) (3, - 1)

(C) (1, 0, 0, - 1)

(D) (1, 3, - 1)

(vi) $p(x) = x^2 - 7\sqrt{7}x + 3$ then $p(7\sqrt{7}) = ?$

(A) 3

(B) $7\sqrt{7}$

(C) $42\sqrt{7} + 3$

(D) $49\sqrt{7}$

(vii) When $x = - 1$, what is the value of the polynomial $2x^3 + 2x$?

(A) 4

(B) 2

(C) - 2

(D) - 4

(viii) If $x-1$ is a factor of the polynomial $3x^2 + mx$ then find the value of m .

(A) 2

(B) - 2

(C) - 3

(D) 3

(ix) Multiply $(x^2 - 3)(2x - 7x^3 + 4)$ and write the degree of the product.

(A) 5

(B) 3

(C) 2

(D) 0

- (x) Which of the following is a linear polynomial ?
 (A) $x + 5$ (B) $x^2 + 5$ (C) $x^3 + 5$ (D) $x^4 + 5$
- (2) Write the degree of the polynomial for each of the following.
 (i) $5 + 3x^4$ (ii) 7 (iii) $ax^7 + bx^9$ (a, b are constants.)
- (3) Write the following polynomials in standard form.
 (i) $4x^2 + 7x^4 - x^3 - x + 9$ (ii) $p + 2p^3 + 10p^2 + 5p^4 - 8$
- (4) Write the following polynomial in coefficient form.
 (i) $x^4 + 16$ (ii) $m^5 + 2m^2 + 3m + 15$
- (5) Write the index form of the polynomial using variable x from its coefficient form.
 (i) $(3, -2, 0, 7, 18)$ (ii) $(6, 1, 0, 7)$ (iii) $(4, 5, -3, 0)$
- (6) Add the following polynomials.
 (i) $7x^4 - 2x^3 + x + 10$; $3x^4 + 15x^3 + 9x^2 - 8x + 2$
 (ii) $3p^3q + 2p^2q + 7$; $2p^2q + 4pq - 2p^3q$
- (7) Subtract the second polynomial from the first.
 (i) $5x^2 - 2y + 9$; $3x^2 + 5y - 7$ (ii) $2x^2 + 3x + 5$; $x^2 - 2x + 3$
- (8) Multiply the following polynomials.
 (i) $(m^3 - 2m + 3)(m^4 - 2m^2 + 3m + 2)$ (ii) $(5m^3 - 2)(m^2 - m + 3)$
- (9) Divide polynomial $3x^3 - 8x^2 + x + 7$ by $x - 3$ using synthetic method and write the quotient and remainder.
- (10) For which the value of m , $x + 3$ is the factor of the polynomial $x^3 - 2mx + 21$?
- (11) At the end of the year 2016, the population of villages Kovad, Varud, Chikhali is $5x^2 - 3y^2$, $7y^2 + 2xy$ and $9x^2 + 4xy$ respectively. At the beginning of the year 2017, $x^2 + xy - y^2$, $5xy$ and $3x^2 + xy$ persons from each of the three villages respectively went to another village for education then what is the remaining total population of these three villages ?
- (12) Polynomials $bx^2 + x + 5$ and $bx^3 - 2x + 5$ are divided by polynomial $x - 3$ and the remainders are m and n respectively. If $m - n = 0$ then find the value of b .
- (13) Simplify. $(8m^2 + 3m - 6) - (9m - 7) + (3m^2 - 2m + 4)$
- (14) Which polynomial is to be subtracted from $x^2 + 13x + 7$ to get the polynomial $3x^2 + 5x - 4$?
- (15) Which polynomial is to be added to $4m + 2n + 3$ to get the polynomial $6m + 3n + 10$?



4

Ratio and Proportion



Let's study.

- Ratio
- Operations on equal ratios
- Continued proportion
- Properties of ratios
- Theorem of equal ratios
- k method



Let's recall.

In earlier standards, we have learnt about ratio and proportion. We have also solved examples based on it. Let us discuss following example.

Ex. The rawa laddoo prepared by Vimal are tasty, for which she takes 1 bowl of ghee, 3 bowls of rawa and 2 bowls of sugar.

Here proportion of rawa and sugar is $3 : 2$ or $\frac{3}{2}$.

If 12 units of rawa is used, how many units of sugar are required ?

Let the number of bowls of sugar required be x .

\therefore from above information, $\frac{3}{2} = \frac{12}{x} \quad \therefore 3x = 24 \quad \therefore x = 8$

That is for preparation of laddoo, with 12 units of rawa requires 8 units of sugar.

Alternatively we can solve the above example in the following way.

$3k$ bowls of rawa, $2k$ bowls of sugar is required because $\frac{3k}{2k} = \frac{3}{2}$

If $3k = 12$ then $k = 4 \quad \therefore 2k = 2 \times 4 = 8$ bowls of sugar is required.



Let's learn.

Ratio and proportion

The concept of ratio of two numbers can be extended to three or more numbers.

Let us see the above example of laddoos. The proportion of ghee, rawa and sugar is $1 : 3 : 2$.

Here proportion of ghee and rawa is $1 : 3$ and that of rawa and sugar is $3 : 2$, This means the proportion of ghee, rawa and sugar is $1 : 3 : 2$.

Let us take k bowls of ghee, $3k$ bowls of rawa and $2k$ bowls of sugar.

Hence for 12 bowls of rawa, how much quantity of ghee and sugar is required can be found as follows.

Now $3k = 12 \quad \therefore k = 4$ and $2k = 8$.

\therefore 4 bowls of ghee and 8 bowls of sugar is required.

The same concept can be extended for proportion of 4 or more entities.

If a, b, c, d are in the ratio $2 : 3 : 7 : 4$ then let us assume that the numbers are $2m, 3m, 7m, 4m$. From the given information, value of m can be determined. For example if the sum of these four numbers is 48, we find these numbers.

$$2m + 3m + 7m + 4m = 16m = 48$$

$$\therefore m = 3$$

$$\therefore 2m = 6, 3m = 9, 7m = 21, 4m = 12$$

\therefore required numbers are 6, 9, 21, 12

Ex (1) The proportion of compounds of nitrogen, phosphorous and potassium in certain fertilizer is $18 : 18 : 10$. Here compound of nitrogen is 18%, compound of phosphorous is 18% and that of potassium is 10%. Remaining part is of other substances. Find the weight of each of the above compounds in 20 kg of fertilizer.

Solution : Let the weight of nitrogen compound in 20 kg of fertilizer be x kg.

$$\therefore \frac{18}{100} = \frac{x}{20} \qquad \therefore x = \frac{18 \times 20}{100} = 3.6$$

\therefore weight of nitrogen compound is 3.6 kg.

The percentage of phosphorous compound is also 18%.

\therefore Weight of compound of phosphorous is 3.6 kg.

If we assume the weight of potassium compound y kg then

$$\frac{10}{100} = \frac{y}{20} \quad \therefore y = 2 \qquad \therefore \text{weight of potassium compound is 2 kg.}$$

Direct proportion

A car covers a distance of 10 km consuming 1 litre of petrol.

It will cover a distance of $20 \times 10 = 200$ km consuming 20 litre of petrol .

Consuming 40 litre of petrol, it will cover a distance of $40 \times 10 = 400$ km.

Let us write this information in tabular form.

Petrol : x litre	1	20	40	
Distance : y km	10	200	400	
$\frac{x}{y}$	$\frac{1}{10}$	$\frac{20}{200} = \frac{1}{10}$	$\frac{40}{400} = \frac{1}{10}$	$\frac{x}{y} = k$

The ratio of consumption of petrol (in litre) and distance covered by the car (in kilometres), is constant. In such case, it is said that the two quantities are in direct proportion or in direct variation.

Inverse proportion

A car takes two hours to cover a distance of 100 km at the speed of 50 km/hr. A bullock-cart travels 5 km in 1 hour. To cover a distance of 100 km at the speed of 5 km/hr, the bullock-cart takes 20 hours.

We know that, **Speed \times time = distance**

By using the relation let us put the above information in a tabular form.

Vehicle	Speed/hr (x)	Time (y)	$x \times y$	$x \times y = k$
Car	50	2	100	
Bullock-cart	5	20	100	

Hence, we see that, the product of speed of the vehicle and time is constant. In such a case it is said that the quantities are in inverse proportion or in inverse variation.



Let's recall.

Properties of ratio

- (1) Ratio of numbers a and b is written as $a : b$ or $\frac{a}{b}$. a is called the predecessor (first term) and b is called successor (Second term).
- (2) In the ratio of two numbers, if the second term is 100 then it is known as a percentage.
- (3) The ratio remains unchanged, if its terms are multiplied or divided by non-zero number. e.g.. $3 : 4 = 6:8 = 9:12$, Similarly $2:3:5 = 8:12:20$. If k is a non-zero number, then $a : b = ak : bk$ $a : b : c = ak : bk : ck$
- (4) The quantities taken in the ratio must be expressed in the same unit.
- (5) The ratio of two quantities is unitless.

For example The ratio of 2 kg and 300 g is not $2 : 300$,

but it is $2000 : 300$ as ($2 \text{ kg} = 2000 \text{ gm}$) i.e. $20 : 3$

Ex (1) The ratio of ages of Seema and Rajashree is $3 : 1$. The ratio of ages of Rajashree and Atul is $2 : 3$. Then find the ratio of ages of Seema, Rajashree and Atul.

Solution : Seema's age : Rajashree's age = $3 : 1$ Rajashree's age : Atul's age = $2 : 3$

Second term of first ratio should be the same as the first term of second ratio.

Hence to get the continuous ratio, multiplying each term of the first ratio by 2. We get

$$3:1 = 6:2 .$$

$$\frac{\text{Seema's age}}{\text{Rajashree's age}} = \frac{6}{2}, \quad \frac{\text{Rajashree's age}}{\text{Atul's age}} = \frac{2}{3}$$

$$\therefore \text{Seema's age} : \text{Rajashree's age} : \text{Atul's age} = 6 : 2 : 3.$$

Ex (2) The length of a rectangular field is 1.2 km and its breadth is 400 metre. Find the ratio of length to breadth.

Solution : Here the length is in kilometer and breadth is in meter. In order to find the ratio of length to breadth, they must be expressed in same unit. Hence we convert kilometre to meter.

$$1.2 \text{ km} = 1.2 \times 1000 = 1200 \text{ m}$$

$$\therefore \text{ratio of } 1200 \text{ m, to } 400 \text{ m is } \frac{1200}{400} = \frac{3}{1}, \text{ that is } 3 : 1$$

Ex (3) The ratio of expenditure and income of Mahesh is 3 : 5. Find the percentage of expenses to his income.

Solution : The ratio of expenditure to income is 3 : 5. To convert it into percentage, convert second term into 100.

$$\frac{3}{5} = \frac{3 \times 20}{5 \times 20} = \frac{60}{100} \therefore \frac{\text{Expenditure}}{\text{Income}} = \frac{60}{100} = 60\% \therefore \text{Mahesh spends } 60\% \text{ of his income.}$$

Ex (4) The ratio of number of mango trees to chikoo trees in an orchard is 2 : 3. If 5 more trees of each type are planted the ratio of trees would be 5 : 7. Then find the number of mango and chickoo trees in the orchard.

Solution : The ratio of trees is 2 : 3.

Let the number of mango trees = $2x$ and chikoo trees = $3x$

$$\text{From given condition, } \frac{2x+5}{3x+5} = \frac{5}{7}$$

$$14x + 35 = 15x + 25$$

$$\therefore x = 10$$

$$\therefore \text{number of mango trees in the orchard} = 2x = 2 \times 10 = 20$$

$$\text{and number of chikoo trees} = 3x = 3 \times 10 = 30$$

Ex (5) The ratio of two numbers is 5 : 7. If 40 is added in each number, then the ratio becomes 25 : 31, Find the numbers.

Solution : Let the first number be $5x$ and second number be $7x$.

From the given condition, $\frac{5x+40}{7x+40} = \frac{25}{31}$

$$31(5x+40) = 25(7x+40)$$

$$155x+1240 = 175x+1000$$

$$1240-1000 = 175x-155x$$

$$240 = 20x$$

$$x = 12$$

$$\therefore \text{first number} = 5 \times 12 = 60 \text{ and second number} = 7 \times 12 = 84$$

$$\therefore \text{given numbers are } 60 \text{ and } 84.$$

Practice set 4.1

- (1) From the following pairs of numbers, find the reduced form of ratio of first number to second number.
(i) 72, 60 (ii) 38,57 (iii) 52,78
- (2) Find the reduced form of the ratio of the first quantity to second quantity.
(i) 700 ₹, 308 ₹ (ii) 14 ₹, 12 ₹. 40 paise.
(iii) 5 litre, 2500 ml (iv) 3 years 4 months, 5 years 8 months
(v) 3.8 kg, 1900 gm (vi) 7 minutes 20 seconds, 5 minutes 6 seconds.
- (3) Express the following percentages as ratios in the reduced form.
(i) 75 : 100 (ii) 44 : 100 (iii) 6.25% (iv) 52 : 100 (v) 0.64%
- (4) Three persons can build a small house in 8 days. To build the same house in 6 days, how many persons are required?
- (5) Convert the following ratios into percentage.
(i) 15 : 25 (ii) 47 : 50 (iii) $\frac{7}{10}$ (iv) $\frac{546}{600}$ (v) $\frac{7}{16}$
- (6) The ratio of ages of Abha and her mother is 2 : 5. At the time of Abha's birth her mother's age was 27 year. Find the present ages of Abha and her mother.
- (7) Present ages of Vatsala and Sara are 14 years and 10 years respectively. After how many years the ratio of their ages will become 5 : 4?
- (8) The ratio of present ages of Rehana and her mother is 2 : 7. After 2 years, the ratio of their ages will be 1 : 3. What is Rehana's present age ?



Let's learn.

Comparison of ratios

The numbers a, b, c, d being positive, comparison of ratios $\frac{a}{b}, \frac{c}{d}$ can be done using following rules :

(i) If $ad > bc$ then $\frac{a}{b} > \frac{c}{d}$ (ii) If $ad < bc$ then $\frac{a}{b} < \frac{c}{d}$

(iii) If $ad = bc$ then $\frac{a}{b} = \frac{c}{d}$

Compare the following pairs of ratios.

Ex (1) $\frac{4}{9}, \frac{7}{8}$

Solution : $4 \times 8 \quad [?] \quad 7 \times 9$
 $32 < 63$
 $\therefore \frac{4}{9} < \frac{7}{8}$

Ex (2) $\frac{\sqrt{13}}{\sqrt{8}}, \frac{\sqrt{7}}{\sqrt{5}}$
 $\sqrt{13} \times \sqrt{5}, \quad [?] \quad \sqrt{8} \times \sqrt{7}$

$\sqrt{65} \quad [?] \quad \sqrt{56}$

$\sqrt{65} > \sqrt{56}$

$\therefore \frac{\sqrt{13}}{\sqrt{8}} > \frac{\sqrt{7}}{\sqrt{5}}$

Ex (3) If a and b are integers and $a < b, b > 1$ then compare $\frac{a-1}{b-1}, \frac{a+1}{b+1}$.

Solution : $a < b \quad \therefore a - 1 < b - 1$

Now consider the subtraction $\frac{a-1}{b-1} - \frac{a+1}{b+1}$

$$\begin{aligned} \frac{a-1}{b-1} - \frac{a+1}{b+1} &= \frac{(a-1)(b+1) - (a+1)(b-1)}{(b-1)(b+1)} \\ &= \frac{(ab-b+a-1) - (ab+b-a-1)}{b^2-1} \\ &= \frac{ab-b+a-1-ab-b+a+1}{b^2-1} \\ &= \frac{2a-2b}{b^2-1} \\ &= \frac{2(a-b)}{b^2-1} \dots\dots\dots (1) \end{aligned}$$

Now $a < b \quad \therefore a - b < 0$

also $b^2-1 > 0$ because $b > 1$

$$\frac{2(a-b)}{b^2-1} < 0 \dots\dots\dots (2)$$

$\frac{a-1}{b-1} - \frac{a+1}{b+1} < 0 \dots\dots$ from (1) & (2)

$$\frac{a-1}{b-1} < \frac{a+1}{b+1}$$

Ex (4) If $a : b = 2 : 1$ and $b : c = 4 : 1$ then find the value of $\left(\frac{a^4}{32b^2c^2}\right)^3$.

Solution : $\frac{a}{b} = \frac{2}{1} \quad \therefore a = 2b \quad \frac{b}{c} = \frac{4}{1} \quad \therefore b = 4c$

$$a = 2b = 2 \times 4c = 8c \quad \therefore a = 8c$$

Now substituting the values $a = 8c$, $b = 4c$

$$\left(\frac{a^4}{32b^2c^2}\right)^3 = \left(\frac{(8c)^4}{32 \times 4^2 \times c^2 \times c^2}\right)^3$$

$$= \left[\frac{8 \times 8 \times 8 \times 8 \times c^4}{32 \times 16 \times c^2 \times c^2}\right]^3$$

$$= (8)^3$$

$$\therefore \left(\frac{a^4}{32b^2c^2}\right)^3 = 512$$

Practice set 4.2

(1) Using the property $\frac{a}{b} = \frac{ak}{bk}$, fill in the blanks substituting proper numbers in the following.

(i) $\frac{5}{7} = \frac{\dots}{28} = \frac{35}{\dots} = \frac{\dots}{3.5}$

(ii) $\frac{9}{14} = \frac{4.5}{\dots} = \frac{\dots}{42} = \frac{\dots}{3.5}$

(2) Find the following ratios.

(i) The ratio of radius to circumference of the circle.

(ii) The ratio of circumference of circle with radius r to its area.

(iii) The ratio of diagonal of a square to its side, if the length of side is 7 cm.

(iv) The lengths of sides of a rectangle are 5 cm and 3.5 cm. Find the ratio of its perimeter to area.

(3) Compare the following pairs of ratios.

(i) $\frac{\sqrt{5}}{3}, \frac{3}{\sqrt{7}}$

(ii) $\frac{3\sqrt{5}}{5\sqrt{7}}, \frac{\sqrt{63}}{\sqrt{125}}$

(iii) $\frac{5}{18}, \frac{17}{121}$

(iv) $\frac{\sqrt{80}}{\sqrt{48}}, \frac{\sqrt{45}}{\sqrt{27}}$

(v) $\frac{9.2}{5.1}, \frac{3.4}{7.1}$

(4) (i) $\square ABCD$ is a parallelogram. The ratio of $\angle A$ and $\angle B$ of this parallelogram is 5 : 4. Find the measure of $\angle B$.

(ii) The ratio of present ages of Albert and Salim is 5 : 9. Five years hence ratio of their ages will be 3 : 5. Find their present ages.

(iii) The ratio of length and breadth of a rectangle is 3 : 1, and its perimeter is 36 cm. Find the length and breadth of the rectangle.

(iv) The ratio of two numbers is 31 : 23 and their sum is 216. Find these numbers.

(v) If the product of two numbers is 360 and their ratio is 10 : 9, then find the numbers.

(5*) If $a : b = 3 : 1$ and $b : c = 5 : 1$ then find the value of (i) $\left(\frac{a^3}{15b^2c}\right)^3$ (ii) $\frac{a^2}{7bc}$

(6*) If $\sqrt{0.04 \times 0.4 \times a} = 0.4 \times 0.04 \times \sqrt{b}$ then find the ratio $\frac{a}{b}$.

(7) $(x + 3) : (x + 11) = (x - 2) : (x + 1)$ then find the value of x .



Let's learn.

Operations on equal ratios

Using the properties of equality, we can perform some operations on ratios. Let's study them.

Let us learn some properties of the equal ratios, if a, b, c, d , are positive integers.

(I) Invertendo : If $\frac{a}{b} = \frac{c}{d}$ then $\frac{b}{a} = \frac{d}{c}$

$$\begin{aligned} \frac{a}{b} &= \frac{c}{d} \\ \therefore a \times d &= b \times c \\ \therefore b \times c &= a \times d \\ \therefore \frac{b \times c}{a \times c} &= \frac{a \times d}{a \times c} \quad \dots(\text{dividing both sides by } a \times c) \\ \frac{b}{a} &= \frac{d}{c} \end{aligned}$$

\therefore If $\frac{a}{b} = \frac{c}{d}$ then $\frac{b}{a} = \frac{d}{c}$. **This property is known as Invertendo.**

(II) Alternando : If $\frac{a}{b} = \frac{c}{d}$ then $\frac{a}{c} = \frac{b}{d}$

$$\begin{aligned} \frac{a}{b} &= \frac{c}{d} \\ \therefore a \times d &= b \times c \\ \frac{a \times d}{c \times d} &= \frac{b \times c}{c \times d} \quad \dots(\text{dividing both sides by } c \times d) \\ \frac{a}{c} &= \frac{b}{d} \end{aligned}$$

If $\frac{a}{b} = \frac{c}{d}$ then $\frac{a}{c} = \frac{b}{d}$. **This property is known as Alternando.**

(III) Componendo : If $\frac{a}{b} = \frac{c}{d}$ then $\frac{a+b}{b} = \frac{c+d}{d}$

$$\frac{a}{b} = \frac{c}{d}$$

$$\frac{a}{b} + 1 = \frac{c}{d} + 1 \quad \dots(\text{adding } 1 \text{ to both sides})$$

$$\frac{a+b}{b} = \frac{c+d}{d}$$

If $\frac{a}{b} = \frac{c}{d}$ then $\frac{a+b}{b} = \frac{c+d}{d}$. **This property is known as Componendo.**

(IV) Dividendo : If $\frac{a}{b} = \frac{c}{d}$ then $\frac{a-b}{b} = \frac{c-d}{d}$

$$\therefore \frac{a}{b} = \frac{c}{d}$$

$$\therefore \frac{a}{b} - 1 = \frac{c}{d} - 1 \quad \dots(\text{subtracting } 1 \text{ from both sides})$$

$$\therefore \frac{a-b}{b} = \frac{c-d}{d}$$

If $\frac{a}{b} = \frac{c}{d}$ then $\frac{a-b}{b} = \frac{c-d}{d}$. **This property is known as Dividendo.**

(V) Componendo-Dividendo : If $\frac{a}{b} = \frac{c}{d}$ then $\frac{a+b}{a-b} = \frac{c+d}{c-d}$, $a \neq b$, $c \neq d$

$$\text{If } \frac{a}{b} = \frac{c}{d} \quad \therefore \frac{a+b}{b} = \frac{c+d}{d} \quad \dots(\text{using componendo}) \quad \dots(1)$$

$$\therefore \frac{a-b}{b} = \frac{c-d}{d} \quad \dots(\text{using dividendo}) \quad \dots(2)$$

$$\therefore \frac{a+b}{a-b} = \frac{c+d}{c-d} \quad \dots\text{from (1) and (2)}$$

If $\frac{a}{b} = \frac{c}{d}$ then $\frac{a+b}{a-b} = \frac{c+d}{c-d}$. **This property is known as Componendo-dividendo.**

General form of Componendo and Dividendo

$$\text{If } \frac{a}{b} = \frac{c}{d} \text{ then } \frac{a+b}{b} = \frac{c+d}{d} \quad \dots(\text{performing componendo once})$$

$$\frac{a+2b}{b} = \frac{c+2d}{d} \quad \dots(\text{performing componendo twice})$$

$$\text{Generally } \frac{a+mb}{b} = \frac{c+md}{d} \quad \dots(\text{performing componendo } m \text{ times}) \quad \dots(\text{I})$$

$$\text{Similarly if } \frac{a}{b} = \frac{c}{d} \text{ then } \frac{a-mb}{b} = \frac{c-md}{d} \quad \dots(\text{performing dividendo } m \text{ time}) \quad \dots(\text{II})$$

$$\text{and if } \frac{a}{b} = \frac{c}{d} \text{ then } \frac{a+mb}{a-mb} = \frac{c+md}{c-md} \quad \dots[\text{dividing (I) by (II)}]$$

**Remember this !**

If $\frac{a}{b} = \frac{c}{d}$ then $\frac{b}{a} = \frac{d}{c}$ (Invertendo)

If $\frac{a}{b} = \frac{c}{d}$ then $\frac{a+b}{b} = \frac{c+d}{d}$ (Componendo)

If $\frac{a}{b} = \frac{c}{d}$ then $\frac{a}{c} = \frac{b}{d}$ (Alternando)

If $\frac{a}{b} = \frac{c}{d}$ then $\frac{a-b}{b} = \frac{c-d}{d}$ (Dividendo)

If $\frac{a}{b} = \frac{c}{d}$ then $\frac{a+b}{a-b} = \frac{c+d}{c-d}$ (Componendo-Dividendo)

Solved Examples :

Ex (1) If $\frac{a}{b} = \frac{5}{3}$ then find the ratio $\frac{a+7b}{7b} = \dots$

Method I

Solution : If $\frac{a}{b} = \frac{5}{3}$ then $\frac{a}{5} = \frac{b}{3} = k$,
... (using alternando)

$$\therefore a = 5k, b = 3k$$

$$\therefore \frac{a+7b}{7b} = \frac{5k+7 \times 3k}{7 \times 3k}$$

$$= \frac{5k+21k}{21k}$$

$$= \frac{26k}{21k} = \frac{26}{21}$$

Method II

$$\frac{a}{b} = \frac{5}{3}$$

$$\therefore \frac{a}{7b} = \frac{5}{21}$$

$$\therefore \frac{a+7b}{7b} = \frac{5+21}{21} \quad \dots \text{(using componendo)}$$

$$\therefore \frac{a+7b}{7b} = \frac{26}{21}$$

Ex. (2) If $\frac{a}{b} = \frac{7}{4}$ then find the ratio $\frac{5a-b}{b} = \dots$

Method I

Solution : $\frac{a}{b} = \frac{7}{4}$

$$\therefore \frac{a}{7} = \frac{b}{4} \quad \dots \text{(using alternando)}$$

Let $\frac{a}{7} = \frac{b}{4} = m$

$$\therefore a = 7m, b = 4m$$

$$\therefore \frac{5a-b}{b} = \frac{5(7m) - 4m}{4m}$$

$$= \frac{35m - 4m}{4m}$$

$$= \frac{31}{4}$$

Method II

$$\frac{a}{b} = \frac{7}{4}$$

$$\frac{5a}{b} = \frac{5 \times 7}{4}$$

$$= \frac{35}{4}$$

$$\frac{5a-b}{b} = \frac{35-4}{4} \quad \dots \text{(using dividendo)}$$

$$\frac{5a-b}{b} = \frac{31}{4}$$

Ex. (3) If $\frac{a}{b} = \frac{7}{3}$ then find the value of the ratio $\frac{a+2b}{a-2b}$.

Solution : Method I :

$$\begin{aligned} \text{Let } a &= 7m, b = 3m \\ \therefore \frac{a+2b}{a-2b} &= \frac{7m+2 \times 3m}{7m-2 \times 3m} \\ &= \frac{7m+6m}{7m-6m} \\ &= \frac{13m}{m} = \frac{13}{1} \end{aligned}$$

Method II : $\therefore \frac{a}{b} = \frac{7}{3}$

$$\begin{aligned} \therefore \frac{a}{2b} &= \frac{7}{6} \dots (\text{multiplying both sides by } \frac{1}{2}) \\ \therefore \frac{a+2b}{a-2b} &= \frac{7+6}{7-6} \quad (\text{using componendo} \\ &\quad \text{- dividendo)} \\ \therefore \frac{a+2b}{a-2b} &= \frac{13}{1} \end{aligned}$$

Ex (4) If $\frac{a}{3} = \frac{b}{2}$ then find the value of the ratio $\frac{5a+3b}{7a-2b}$.

Solution : Method I

$$\begin{aligned} \frac{a}{3} &= \frac{b}{2} \\ \therefore \frac{a}{b} &= \frac{3}{2} \dots \dots \dots (\text{using Alternando}) \end{aligned}$$

Now dividing each term of $\frac{5a+3b}{7a-2b}$ by b .

$$\begin{aligned} \frac{\frac{5a}{b} + \frac{3b}{b}}{\frac{7a}{b} - \frac{2b}{b}} &= \frac{5\left(\frac{a}{b}\right) + 3}{7\left(\frac{a}{b}\right) - 2} \\ &= \frac{5\left(\frac{3}{2}\right) + 3}{7\left(\frac{3}{2}\right) - 2} \\ &= \frac{\frac{15}{2} + 3}{\frac{21}{2} - 2} \\ &= \frac{15+6}{21-4} \\ &= \frac{21}{17} \end{aligned}$$

Method II

$$\begin{aligned} \frac{a}{3} &= \frac{b}{2} \\ \text{Let } \frac{a}{3} = \frac{b}{2} &= t. \end{aligned}$$

\therefore by substituting $a = 3t$ and $b = 2t$,

$$\begin{aligned} \frac{5a+3b}{7a-2b} &= \frac{5(3t)+3(2t)}{7(3t)-2(2t)} \quad (t \neq 0) \\ &= \frac{15t+6t}{21t-4t} \\ &= \frac{21t}{17t} \\ &= \frac{21}{17} \end{aligned}$$

Ex (5) If $\frac{x}{y} = \frac{4}{5}$ then find the value of the ratio $\frac{4x-y}{4x+y}$.

Solution :

$$\frac{x}{y} = \frac{4}{5}$$

$$\frac{4x}{y} = \frac{16}{5}$$

...(multiplying both sides by 4)

$$\therefore \frac{4x+y}{4x-y} = \frac{16+5}{16-5}$$

...(using componendo-dividendo)

$$\therefore \frac{4x+y}{4x-y} = \frac{21}{11}$$

$$\therefore \frac{4x-y}{4x+y} = \frac{11}{21}$$

∴

Ex (6) If $5x = 4y$ then find the value of the ratio $\frac{3x^2 + y^2}{3x^2 - y^2}$.

Solution :

$$\frac{x}{y} = \frac{4}{5}$$

$$\frac{x^2}{y^2} = \frac{16}{25}$$

$$\therefore \frac{3x^2}{y^2} = \frac{48}{25}$$

...(multiplying both sides by 3)

$$\therefore \frac{3x^2 + y^2}{3x^2 - y^2} = \frac{48+25}{48-25}$$

...(using componendo-dividendo)

$$\therefore \frac{3x^2 + y^2}{3x^2 - y^2} = \frac{73}{23}$$

∴



Let's learn.

Application of properties of equal ratios

To solve some types of equations, it is convenient to use properties of equal ratios rather than using other methods.

Ex (1) Solve the equation. $\frac{3x^2 + 5x + 7}{10x + 14} = \frac{3x^2 + 4x + 3}{8x + 6}$

Solution : $\frac{3x^2 + 5x + 7}{10x + 14} = \frac{3x^2 + 4x + 3}{8x + 6}$

$$\frac{(6x^2 + 10x + 14)}{10x + 14} = \frac{(6x^2 + 8x + 6)}{8x + 6} \quad \dots(\text{multiplying both sides by } 2)$$

$$\frac{(6x^2 + 10x + 14) - (10x + 14)}{10x + 14} = \frac{(6x^2 + 8x + 6) - (8x + 6)}{8x + 6} \quad \dots(\text{using dividendo})$$

$$\therefore \frac{6x^2}{10x + 14} = \frac{6x^2}{8x + 6}$$

This equation is true for $x = 0$ $\therefore x = 0$ is a solution of the given equation.

If $x \neq 0$ then $x^2 \neq 0$, \therefore dividing by $6x^2$, $\frac{1}{10x + 14} = \frac{1}{8x + 6}$

$$\therefore 8x + 6 = 10x + 14$$

$$\therefore 6 - 14 = 10x - 8x$$

$$\therefore -8 = 2x$$

$$\therefore x = -4$$

$\therefore x = -4$ or $x = 0$ are the solutions of the given equation.

Ex (2) Solve. $\frac{\sqrt{x+7} + \sqrt{x-2}}{\sqrt{x+7} - \sqrt{x-2}} = \frac{5}{1}$

Solution : $\frac{(\sqrt{x+7} + \sqrt{x-2}) + (\sqrt{x+7} - \sqrt{x-2})}{(\sqrt{x+7} + \sqrt{x-2}) - (\sqrt{x+7} - \sqrt{x-2})} = \frac{5+1}{5-1} \quad \dots(\text{using componendo-dividendo})$

$$\therefore \frac{2\sqrt{x+7}}{2\sqrt{x-2}} = \frac{6}{4}$$

$$\therefore \frac{\sqrt{x+7}}{\sqrt{x-2}} = \frac{3}{2}$$

$$\therefore \frac{x+7}{x-2} = \frac{9}{4} \quad \dots(\text{squaring both sides of the equation})$$

$$\therefore 4x + 28 = 9x - 18$$

$$\therefore 28 + 18 = 9x - 4x$$

$$\therefore 46 = 5x$$

$$\therefore \frac{46}{5} = x$$

$$\therefore x = \frac{46}{5} \text{ is the solution of the given equation.}$$

Activity :

Take 5 pieces of card paper. Write the following statements, one on each paper.

(i) $\frac{a+b}{b} = \frac{c+d}{d}$ (ii) $\frac{a}{c} = \frac{b}{d}$ (iii) $\frac{a}{b} = \frac{ac}{bd}$ (iv) $\frac{c}{d} = \frac{c-a}{d-b}$ (v) $\frac{a}{b} = \frac{rc}{rd}$

a, b, c, d are positive numbers and $\frac{a}{b} = \frac{c}{d}$ is given. Which of the above statements are true or false, write at the back of each card, if false explain why.

Practice set 4.3

(1) If $\frac{a}{b} = \frac{7}{3}$ then find the values of the following ratios.

(i) $\frac{5a+3b}{5a-3b}$ (ii) $\frac{2a^2+3b^2}{2a^2-3b^2}$ (iii) $\frac{a^3-b^3}{b^3}$ (iv) $\frac{7a+9b}{7a-9b}$

(2) If $\frac{15a^2+4b^2}{15a^2-4b^2} = \frac{47}{7}$ then find the values of the following ratios.

(i) $\frac{a}{b}$ (ii) $\frac{7a-3b}{7a+3b}$ (iii) $\frac{b^2-2a^2}{b^2+2a^2}$ (iv) $\frac{b^3-2a^3}{b^3+2a^3}$

(3) If $\frac{3a+7b}{3a-7b} = \frac{4}{3}$ then find the value of the ratio $\frac{3a^2-7b^2}{3a^2+7b^2}$.

(4) Solve the following equations.

(i) $\frac{x^2+12x-20}{3x-5} = \frac{x^2+8x+12}{2x+3}$

(ii) $\frac{10x^2+15x+63}{5x^2-25x+12} = \frac{2x+3}{x-5}$

(iii) $\frac{(2x+1)^2+(2x-1)^2}{(2x+1)^2-(2x-1)^2} = \frac{17}{8}$

(iv*) $\frac{\sqrt{4x+1}+\sqrt{x+3}}{\sqrt{4x+1}-\sqrt{x+3}} = \frac{4}{1}$

(v) $\frac{(4x+1)^2+(2x+3)^2}{4x^2+12x+9} = \frac{61}{36}$

(vi) $\frac{(3x-4)^3-(x+1)^3}{(3x-4)^3+(x+1)^3} = \frac{61}{189}$

Activity : In the following activity, the values of a and b can be changed. That is by changing $a : b$ we can create many examples. Teachers should give lot of practice to the students and encourage them to construct their own examples.

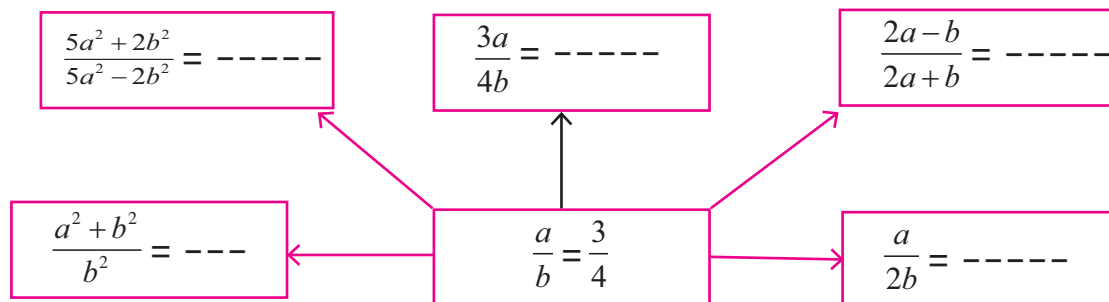



Let's learn.

Theorem on equal ratios

If $\frac{a}{b} = \frac{c}{d}$ then $\frac{a}{b} = \frac{a+c}{b+d} = \frac{c}{d}$ This property is called the theorem of equal ratios.

Prrof : Let $\frac{a}{b} = \frac{c}{d} = k$. $\therefore a = bk$ and $c = dk$

$$\therefore \frac{a+c}{b+d} = \frac{bk+dk}{b+d} = \frac{k(b+d)}{b+d} = k$$

$$\therefore \frac{a}{b} = \frac{c}{d} = \frac{a+c}{b+d}$$

We know that, $\frac{a}{b} = \frac{al}{bl}$

$$\therefore \text{If } \frac{a}{b} = \frac{c}{d} = k, \text{ then } \frac{al}{bl} = \frac{cm}{dm} = \frac{al+cm}{bl+dm} = k$$

If $\frac{a}{b} = \frac{c}{d} = \frac{e}{f} = \dots\dots\dots$ (finite terms) and if l, m, n are non-zero numbers

then each ratio = $\frac{al+cm+en+\dots}{bl+dm+fn+\dots}$ (finite terms) is the general form of the above

theorem.



Use your brain power !

In a certain gymnasium, there are 35 girls and 42 boys in the kid's section, 30 girls and 36 boys in the children's section and 20 girls and 24 boys in the teens' section. What is the ratio of the number of boys to the number of girls in every section ?

For physical exercises, all three groups gathered on the ground. Now what is the ratio of number of boys to the number of girls ?

From the answers of the above questions, did you verify the theorem of equal ratios ?

Ex (1) Fill in the blanks in the following statements.

(i) $\frac{a}{3} = \frac{b}{7} = \frac{4a+9b}{\dots\dots\dots}$ (ii) $\frac{x}{3} = \frac{y}{5} = \frac{z}{4} = \frac{5x-3y+4z}{\dots\dots\dots}$

Solution : (i) $\frac{a}{3} = \frac{b}{7} = \frac{4a+9b}{4 \times 3 + 9 \times 7} = \frac{4a+9b}{12+63} = \frac{4a+9b}{75}$

(ii) $\frac{x}{3} = \frac{y}{5} = \frac{z}{4} = \frac{5 \times x}{5 \times 3} = \frac{-3 \times y}{-3 \times 5} = \frac{4 \times z}{4 \times 4}$
 $\therefore = \frac{5x}{15} = \frac{-3y}{-15} = \frac{4z}{16}$
 $= \frac{5x-3y+4z}{15-15+16}$ -----(by the theorem of equal ratio)
 $= \frac{5x-3y+4z}{16}$

If $x = 0$ then $\frac{14x^2 - 6x + 8}{10x^2 + 4x + 7} = \frac{8}{7}$ and $\frac{7x - 3}{5x + 2} = \frac{-3}{2}$

$\therefore \frac{8}{7} = \frac{-3}{2}$ Which is a contradiction.

$\therefore x \neq 0$

\therefore multiplying predecessor and successor of RHS by $2x$.

$$\frac{14x^2 - 6x + 8}{10x^2 + 4x + 7} = \frac{2x(7x - 3)}{2x(5x + 2)} = k$$

$$\therefore \frac{14x^2 - 6x + 8}{10x^2 + 4x + 7} = \frac{14x^2 - 6x}{10x^2 + 4x} = k$$

$$\therefore \frac{14x^2 - 6x + 8 - 14x^2 + 6x}{10x^2 + 4x + 7 - 10x^2 - 4x} = \frac{8}{7} = k$$

$$\therefore k = \frac{8}{7}$$

$$\therefore \frac{7x - 3}{5x + 2} = \frac{8}{7}$$

$$\therefore 49x - 21 = 40x + 16$$

$$\therefore 49x - 40x = 16 + 21$$

$$\therefore 9x = 37 \quad \therefore x = \frac{37}{9}$$

Practice set 4.4

(1) Fill in the blanks of the following

(i) $\frac{x}{7} = \frac{y}{3} = \frac{3x + 5y}{\dots\dots} = \frac{7x - 9y}{\dots\dots}$ (ii) $\frac{a}{3} = \frac{b}{4} = \frac{c}{7} = \frac{a - 2b + 3c}{\dots\dots} = \frac{\dots\dots}{6 - 8 + 14}$

(2) $5m - n = 3m + 4n$ then find the values of the following expressions.

(i) $\frac{m^2 + n^2}{m^2 - n^2}$ (ii) $\frac{3m + 4n}{3m - 4n}$

(3) (i) If $a(y+z) = b(z+x) = c(x+y)$ and out of a, b, c no two of them are equal

then show that, $\frac{y-z}{a(b-c)} = \frac{z-x}{b(c-a)} = \frac{x-y}{c(a-b)}$.

(ii) If $\frac{x}{3x - y - z} = \frac{y}{3y - z - x} = \frac{z}{3z - x - y}$ and $x + y + z \neq 0$ then show that the value of each ratio is equal to 1.

(iii) If $\frac{ax+by}{x+y} = \frac{bx+az}{x+z} = \frac{ay+bz}{y+z}$ and $x+y+z \neq 0$ then show that $\frac{a+b}{2}$.

(iv) If $\frac{y+z}{a} = \frac{z+x}{b} = \frac{x+y}{c}$ then show that $\frac{x}{b+c-a} = \frac{y}{c+a-b} = \frac{z}{a+b-c}$.

(v) If $\frac{3x-5y}{5z+3y} = \frac{x+5z}{y-5x} = \frac{y-z}{x-z}$ then show that every ratio = $\frac{x}{y}$.

(4) Solve. (i) $\frac{16x^2 - 20x + 9}{8x^2 + 12x + 21} = \frac{4x - 5}{2x + 3}$ (ii) $\frac{5y^2 + 40y - 12}{5y + 10y^2 - 4} = \frac{y + 8}{1 + 2y}$



Let's learn.

Continued Proportion

Let us consider the ratios 4 : 12 and 12 : 36. They are equal ratios. In the two ratios, the successor (second term) of the first ratio is equal to the predecessor (first term) of the second ratio. Hence 4, 12, 36 are said to be in continued proportion.

If $\frac{a}{b} = \frac{b}{c}$ then a, b, c are in continued proportion.

If $ac = b^2$, then dividing both sides by bc we get $\frac{a}{b} = \frac{b}{c}$.

\therefore if $ac = b^2$, then a, b, c are in continued proportion.

When a, b, c are in continued proportion then b is known as **Geometric mean** of a and c or **Mean proportional** of a and c .

Hence all the following statements convey the same meaning.

\therefore (1) $\frac{a}{b} = \frac{b}{c}$ (2) $b^2 = ac$ (3) a, b, c are in continued proportion.

(4) b is the geometric mean of a and c .

(5) b is the mean proportional of a and c .

We can generalise the concept of continued proportion.

If $\frac{a}{b} = \frac{b}{c} = \frac{c}{d} = \frac{d}{e} = \frac{e}{f}$ then a, b, c, d, e and f are said to be in continued proportion.

Ex (1) If x is the geometric mean of 25 and 4, then find the value of x .

Solution : x is the geometric mean of 25 and 4.

$$\therefore x^2 = 25 \times 4$$

$$\therefore x^2 = 100$$

$$\therefore x = 10$$

Ex (2) If $4a^2b$, $8ab^2$, p are in continued proportion then find the value of p .

Solution : From given information, $4a^2b$, $8ab^2$, p are in continued proportion.

$$\begin{aligned} \therefore \frac{4a^2b}{8ab^2} &= \frac{8ab^2}{p} \\ p &= \frac{8ab^2 \times 8ab^2}{4a^2b} = 16b^3 \end{aligned}$$

Ex (3) Which number should be subtracted from 7, 12 and 18 such that the resultant numbers are in continued proportion?

Solution : Let x be subtracted from 7, 12 and 18 such that resultant numbers are in continued proportion.

$(7-x), (12-x), (18-x)$ are in continued proportion. $\therefore (12-x)^2 = (7-x)(18-x)$ $\therefore 144 - 24x + x^2 = 126 - 25x + x^2$ $\therefore -24x + 25x = 126 - 144$ $\therefore x = -18$		<p style="text-align: right;">Tally</p> $(7-x) = 7 - (-18) = 25$ $(12-x) = 12 - (-18) = 30$ $(18-x) = 18 - (-18) = 36$ $30^2 = 900$ and $25 \times 36 = 900$ 25, 30, 36 are in continued proportion
--	--	---

\therefore If -18 is subtracted from 7, 12, 18 the resultant numbers are in continued proportion.

k - method

The k -method is used to solve examples based on equal ratios, i.e. equal proportions.

In this simple method every equal ratio is assumed to be equal to k .

Ex (1) If $\frac{a}{b} = \frac{c}{d}$ then show that $\frac{5a-3c}{5b-3d} = \frac{7a-2c}{7b-2d}$

Solution : Let $\frac{a}{b} = \frac{c}{d} = k \quad \therefore a = bk, c = dk$

Substituting values of a and c in both sides,

$$\begin{aligned} \text{LHS} &= \frac{5a-3c}{5b-3d} = \frac{5(bk)-3(dk)}{5b-3d} = \frac{k(5b-3d)}{(5b-3d)} = k \\ \text{RHS} &= \frac{7a-2c}{7b-2d} = \frac{7(bk)-2(dk)}{7b-2d} = \frac{k(7b-2d)}{7b-2d} = k \\ \therefore \text{LHS} &= \text{RHS.} \end{aligned}$$

$$\therefore \frac{5a-3c}{5b-3d} = \frac{7a-2c}{7b-2d}$$

Ex (2) If a, b, c are in continued proportion then show that, $\frac{(a+b)^2}{ab} = \frac{(b+c)^2}{bc}$.

Solution : a, b, c are in continued proportion. Let $\frac{a}{b} = \frac{b}{c} = k$.

$$\therefore b = ck, \quad a = bk = ck \times k = ck^2$$

Substituting values of a and b .

$$\text{LHS} = \frac{(a+b)^2}{ab} = \frac{(ck^2 + ck)^2}{(ck^2)(ck)} = \frac{c^2k^2(k+1)^2}{c^2k^3} = \frac{(k+1)^2}{k}$$

$$\text{RHS} = \frac{(b+c)^2}{bc} = \frac{(ck + c)^2}{(ck)c} = \frac{c^2(k+1)^2}{c^2k} = \frac{(k+1)^2}{k}$$

$$\therefore \text{LHS} = \text{RHS.} \quad \therefore \frac{(a+b)^2}{ab} = \frac{(b+c)^2}{bc}$$

Ex (3) If a, b, c are in continued proportion

then show that $\frac{a}{c} = \frac{a^2 + ab + b^2}{b^2 + bc + c^2}$

Solution : a, b, c are in continued proportion.

$$\therefore \frac{a}{b} = \frac{b}{c}$$

$$\text{Let, } \frac{a}{b} = \frac{b}{c} = k \quad \therefore b = ck \quad \text{and } a = ck^2$$

$$\text{LHS} = \frac{a}{c} = \frac{ck^2}{c} = k^2$$

$$\begin{aligned} \text{RHS} &= \frac{a^2 + ab + b^2}{b^2 + bc + c^2} \\ &= \frac{(k^2c)^2 + k^2c(ck) + (ck)^2}{(ck)^2 + (ck)(c) + c^2} \\ &= \frac{k^4c^2 + k^3c^2 + c^2k^2}{c^2k^2 + c^2k + c^2} \\ &= \frac{c^2k^2(k^2 + k + 1)}{c^2(k^2 + k + 1)} \\ &= k^2 \end{aligned}$$

$$\therefore \text{LHS} = \text{RHS}$$

$$\therefore \frac{a}{c} = \frac{a^2 + ab + b^2}{b^2 + bc + c^2}$$

Ex (4) Five numbers are in continued proportion. The first term is 5 and the last term is 80. Find these numbers.

Solution : Let the numbers in continued proportion be a, ak, ak^2, ak^3, ak^4 .

$$\text{Here } a = 5 \quad \text{and } ak^4 = 80$$

$$\therefore 5 \times k^4 = 80$$

$$\therefore k^4 = 16$$

$$\therefore k = 2 \quad \because 2^4 = 16$$

$$ak = 5 \times 2 = 10 \quad ak^2 = 5 \times 4 = 20$$

$$ak^3 = 5 \times 8 = 40 \quad ak^4 = 5 \times 16 = 80$$

\therefore the numbers are 5, 10, 20, 40, 80.

Practice set 4.5

- (1) Which number should be subtracted from 12, 16 and 21 so that resultant numbers are in continued proportion?
- (2) If $(28-x)$ is the mean proportional of $(23-x)$ and $(19-x)$ then find the value of x .
- (3) Three numbers are in continued proportion, whose mean proportional is 12 and the sum of the remaining two numbers is 26, then find these numbers.
- (4) If $(a + b + c)(a - b + c) = a^2 + b^2 + c^2$ show that a, b, c are in continued proportion.
- (5) If $\frac{a}{b} = \frac{b}{c}$ and $a, b, c > 0$ then show that,
 - (i) $(a + b + c)(b - c) = ab - c^2$
 - (ii) $(a^2 + b^2)(b^2 + c^2) = (ab + bc)^2$
 - (iii) $\frac{a^2 + b^2}{ab} = \frac{a + c}{b}$
- (6) Find mean proportional of $\frac{x + y}{x - y}, \frac{x^2 - y^2}{x^2 y^2}$

Activity : Observe the political map of India from a Geography textbook. Study the scale of this map.

From the given scale find the straight line distances between various cities like

- (i) New Delhi to Bengaluru (ii) Mumbai to Kolkata, (iii) Jaipur to Bhubaneshwar.

Problem set 4

- (1) Select the appropriate alternative answer for the following questions.
 - (i) If $6 : 5 = y : 20$ then what will be the value of y ?
(A) 15 (B) 24 (C) 18 (D) 22.5
 - (ii) What is the ratio of 1 mm to 1 cm ?
(A) 1 : 100 (B) 10 : 1 (C) 1 : 10 (D) 100 : 1
 - (iii*) The ages of Jatin, Nitin and Mohasin are 16, 24 and 36 years respectively. What is the ratio of Nitin's age to Mohasin's age ?
(A) 3 : 2 (B) 2 : 3 (C) 4 : 3 (D) 3 : 4

- (iv) 24 Bananas were distributed between Shubham and Anil in the ratio 3 : 5, then how many bananas did Shubham get ?
 (A) 8 (B) 15 (C) 12 (D) 9
- (v) What is the mean proportional of 4 and 25 ?
 (A) 6 (B) 8 (C) 10 (D) 12
- (2) For the following numbers write the ratio of first number to second number in the reduced form.
- (i) 21, 48 (ii) 36, 90 (iii) 65, 117 (iv) 138, 161 (v) 114, 133
- (3) Write the following ratios in the reduced form.
- (i) Radius to the diameter of a circle.
 (ii) The ratio of diagonal to the length of a rectangle, having length 4 cm and breadth 3 cm.
 (iii) The ratio of perimeter to area of a square, having side 4 cm.
- (4) Check whether the following numbers are in continued proportion.
- (i) 2, 4, 8 (ii) 1, 2, 3 (iii) 9, 12, 16 (iv) 3, 5, 8
- (5) a, b, c are in continued proportion. If $a = 3$ and $c = 27$ then find b .
- (6) Convert the following ratios into percentages..
- (i) $37 : 500$ (ii) $\frac{5}{8}$ (iii) $\frac{22}{30}$ (iv) $\frac{5}{16}$ (v) $\frac{144}{1200}$
- (7) Write the ratio of first quantity to second quantity in the reduced form.
- (i) 1024 MB, 1.2 GB [(1024 MB = 1 GB)]
 (ii) 17 Rupees, 25 Rupees 60 paise (iii) 5 dozen, 120 units
 (iv) 4 sq.m, 800 sq.cm (v) 1.5 kg, 2500 gm
- (8) If $\frac{a}{b} = \frac{2}{3}$ then find the values of the following expressions.
- (i) $\frac{4a+3b}{3b}$ (ii) $\frac{5a^2+2b^2}{5a^2-2b^2}$
 (iii) $\frac{a^3+b^3}{b^3}$ (iv) $\frac{7b-4a}{7b+4a}$
- (9) If a, b, c, d are in proportion, then prove that
- (i) $\frac{11a^2+9ac}{11b^2+9bd} = \frac{a^2+3ac}{b^2+3bd}$
 (ii*) $\sqrt{\frac{a^2+5c^2}{b^2+5d^2}} = \frac{a}{b}$
 (iii) $\frac{a^2+ab+b^2}{a^2-ab+b^2} = \frac{c^2+cd+d^2}{c^2-cd+d^2}$

(10) If a, b, c are in continued proportion, then prove that

$$(i) \quad \frac{a}{a+2b} = \frac{a-2b}{a-4c} \quad (ii) \quad \frac{b}{b+c} = \frac{a-b}{a-c}$$

(11) Solve : $\frac{12x^2 + 18x + 42}{18x^2 + 12x + 58} = \frac{2x + 3}{3x + 2}$

(12) If $\frac{2x-3y}{3z+y} = \frac{z-y}{z-x} = \frac{x+3z}{2y-3x}$ then prove that every ratio = $\frac{x}{y}$.

(13*) If $\frac{by+cz}{b^2+c^2} = \frac{cz+ax}{c^2+a^2} = \frac{ax+by}{a^2+b^2}$ then prove that $\frac{x}{a} = \frac{y}{b} = \frac{z}{c}$.



5

Linear Equations in Two Variables



Let's study.

- Introduction
- Solving simultaneous equations
- Linear equation in two variables
- Simultaneous equations
- Word problems based on simultaneous equations



Let's recall.

Ex. Solve the following equations.

(1) $m + 3 = 5$

$m = \square$

(2) $3y + 8 = 22$

$y = \square$

(3) $\frac{x}{3} = 2$

$x = \square$

(4) $2p = p + \frac{4}{9}$

$p = \square$

(5) Which number should be added to 5 to obtain 14 ?

$\square + 5 = 14$

$x + 5 = 14$

$x = \square$

(6) Which number should be subtracted from 8 to obtain 2 ?

$8 - \square = 2$

$8 - y = 2$

$y = \square$

In all above equations, degree of the variable is 1. These are called as Linear equations.



Let's learn.

Linear equations in two variables

Find two numbers whose sum is 14.

Using variables x and y for the two numbers, we can form the equation $x + y = 14$.

This is an equation in two variables.

We can find many values of x and y satisfying the condition.

e.g. $9 + 5 = 14$

$7 + 7 = 14$

$8 + 6 = 14$

$4 + 10 = 14$

$(-1) + 15 = 14$

$15 + (-1) = 14$

$2.6 + 11.4 = 14$

$0 + 14 = 14$

$100 + (-86) = 14$

$(-100) + (114) = 14$

$\square + \square = 14$

$\square + \square = 14$

Hence, above equation has many solutions like $(x = 9, y = 5)$; $(x = 7, y = 7)$; $(x = 8, y = 6)$ etc.

Conventionally, the solution $x = 9, y = 5$ is written as an ordered pair $(9, 5)$ where 9 is the value of x and 5 is the value of y . To satisfy the equation $x + y = 14$, we can get infinite ordered pairs like $(9,5), (7,7), (8,6), (4,10), (10,4), (-1,15), (2.6, 11.4), \dots$ etc. All of these are the solutions of $x + y = 14$.

Consider second example.

Find two numbers such that their difference is 2.

Let the greater number be x and the smaller number be y .

Then we get the equation $x - y = 2$

For the values of x and y , we can get following equations.

$$10 - 8 = 2 \quad 9 - 7 = 2 \quad 8 - 6 = 2 \quad (-3) - (-5) = 2 \quad 5.3 - 3.3 = 2$$

$$15 - 13 = 2 \quad 100 - 98 = 2 \quad \square - \square = 2 \quad \square - \square = 2$$

Here if we take values $x = 10$ and $y = 8$, then the ordered pair $(10, 8)$ satisfies the above equation. Here we cannot write as $(8, 10)$ because $(8, 10)$ will imply $x = 8$ and $y = 10$ and it does not satisfy the equation $x - y = 2$. Therefore, note that, the order of numbers in the pair indicating solution is very important.

Now let us write the solutions of $x - y = 2$ in the form of ordered pairs.

$(7, 5), (-2, -4), (0, -2), (5.2, 3.2), (8, 6)$ etc. There are infinite solutions.

Find the solution of $4m - 3n = 2$.

Construct 3 different equations and find their solutions.

Now, observe the first two equations.

$$x + y = 14 \quad \dots\dots\dots \text{I}$$

$$x - y = 2 \quad \dots\dots\dots \text{II}$$

Solution of equation I: $(9, 5), (7, 7), (8, 6)\dots$

Solutions of Equation II: $(7, 5), (-2, -4), (0, -2), (5.2, 3.2), (8, 6)\dots$

$(8, 6)$ is the only common solution of both the equations. This solution satisfies both the equations. Hence it is the unique common solution of both the equations.



Remember this !

When we consider at the same time two linear equations in two variables those equations are called **Simultaneous equations**.

Activity : On the glasses of following spectacles, write numbers such that

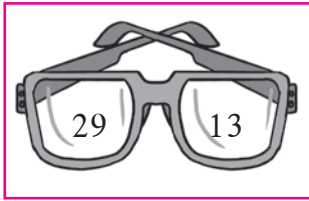

(i) Their sum is 42 and difference is 16 (ii) Their sum is 37 and difference is 11



(iii) Their sum is 54 and difference is 20 (iv) Their sum is ... and difference is ...



Let's recall.

$x+y = 5$ and $2x + 2y = 10$ are two equations in two variables. Find five different solutions of $x+y = 5$, verify whether same solutions satisfy the equation $2x + 2y = 10$ also.

Observe both equations.

Find the condition where two equations in two variables have all solutions in common.



Let's learn.

Elimination method of solving simultaneous equations

By taking different values of variables we have solved the equations $x + y = 14$ and $x - y = 2$. But every time, it is not easy to solve by this method, e.g. , $2x + 3y = -4$ and $x - 5y = 11$. Try to solve these equations by taking different values of x and y . By this method observe that it is not easy to obtain the solution.

Therefore to solve simultaneous equations we use different method. In this method, we eliminate one of the variables to obtain equations in one variable. We can solve and find the value of one of the two variables and then substituting this value in one of the given equations we can find the value of the other variable.

Study the following example to understand this method.

Ex (1) Solve $x + y = 14$ and $x - y = 2$.

Solution : By adding both the equations we get an equation in one variable

$$\begin{array}{rcl} x + y & = & 14 \quad \text{.....I} \\ + \quad x - y & = & 2 \quad \text{.....II} \\ \hline 2x + 0 & = & 16 \\ 2x & = & 16 \\ x & = & 8 \end{array} \quad \left| \begin{array}{l} \text{Substituting } x=8 \text{ in the equation (I)} \\ x + y = 14 \\ \therefore 8 + y = 14 \\ \therefore y = 6 \end{array} \right.$$

Here (8, 6) is the solution of first equation. Let us check, whether it satisfies the second equation also.

$$x - y = 8 - 6 = 2 \text{ is true.}$$

\therefore (8,6) is the solution for both the equations.

Hence (8, 6) is the solution of simultaneous equations $x + y = 14$ and $x - y = 2$.

Ex (2) Sum of the ages of mother and son is 45 years. If son's age is subtracted from twice of mother's age then we get answer 54. Find the ages of mother and son.

It becomes easy to solve a problem if we make use of variables.

Solution : Let the mother's today's age be x years and son's today's age be y years.

$$\text{From the first condition } x+y=45 \quad \text{.....I}$$

$$\text{From the second condition } 2x-y=54 \quad \text{.....II}$$

$$\text{Adding equations (I) and (II)} \quad 3x+0 = 99$$

$$3x = 99$$

$$x = 33$$

$$\text{Substituting } x = 33 \text{ in equation (I), } 33+y = 45$$

$$y = 45-33$$

$$y = 12$$

Verify that $x=33$ and $y = 12$ is the solution of second equation.

Today's age of mother = 33 and today's age of son = 12.

General form of linear equation in two variables

The general form of a linear equation in two variables is $ax + by + c = 0$ where a, b, c are real numbers and a and b are non-zero at the same time.

In this equation the index of both the variables is 1. Hence it is a linear equation.

Ex (1) Solve the following equations

$$3x + y = 5 \dots\dots\dots (I)$$

$$2x + 3y = 1 \dots\dots\dots (II)$$

Solution : To eliminate one of the variables, we observe that in both equations, not a single coefficient is equal or opposite number. Hence we will make one of them equal.

Multiply both sides of the equation (I) by 3.

$$\therefore 3x \times 3 + 3 \times y = 5 \times 3$$

$$\therefore 9x + 3y = 15 \dots\dots\dots (III)$$

$$2x + 3y = 1 \dots\dots\dots (II)$$

Now subtracting eqn (II) from eqn (III)

$$\begin{array}{r} 9x + 3y = 15 \\ + 2x + 3y = 1 \\ \hline 7x = 14 \\ x = 2 \end{array}$$

Substituting $x = 2$ in one of the equations.

$$\begin{aligned} 2x + 3y &= 1 \\ \therefore 2 \times 2 + 3y &= 1 \\ \therefore 4 + 3y &= 1 \\ \therefore 3y &= -3 \\ \therefore y &= -1 \end{aligned}$$

Verify that $(2, -1)$ satisfies the second equation.

Ex (2) Solve the following simultaneous equations.

$$3x - 4y - 15 = 0 \dots\dots\dots (I)$$

$$y + x + 2 = 0 \dots\dots\dots (II)$$

Solution : Let us write the equations by shifting constant terms to RHS

$$3x - 4y = 15 \dots\dots\dots (I)$$

$$x + y = -2 \dots\dots\dots (II)$$

To eliminate y , multiply second equation by 4 and add to equation (I).

$$\begin{array}{r} 3x - 4y = 15 \\ + 4x + 4y = -8 \\ \hline 7x = 7 \\ x = 1 \end{array}$$

Substituting $x = 1$ in the equation (II).

$$\begin{aligned} x + y &= -2 \\ \therefore 1 + y &= -2 \\ \therefore y &= -2 - 1 \\ \therefore y &= -3 \end{aligned}$$

$(1, -3)$ is the solution of the above equations.

Verify that it satisfies equation (I) also.



Use your brain power!

$3x - 4y - 15 = 0$ and $y + x + 2 = 0$. Can these equations be solved by eliminating x ? Is the solution same?



Let's learn.

Substitution method of solving simultaneous equations

There is one more method to eliminate a variable. We can express one variable in terms of other from one of the equations. Then substituting it in the other equation we can eliminate the variable. Let us discuss this method from following examples.

Ex (1) Solve $8x + 3y = 11$; $3x - y = 2$

Solution : $8x + 3y = 11$(I)

$3x - y = 2$(II)

In Equation (II), it is easy to express y in terms of x .

$$3x - y = 2$$

$$3x - 2 = y$$

Substituting $y = 3x - 2$ in equation (I).

$$8x + 3y = 11$$

$$\therefore 8x + 3(3x-2) = 11$$

$$\therefore 8x + 9x - 6 = 11$$

$$\therefore 17x - 6 = 11$$

$$\therefore 17x = 11 + 6 = 17$$

$$\therefore x = 1$$

Now, substituting this value of x in the equation $y = 3x - 2$.

$$y = 3 \times 1 - 2$$

$$\therefore y = 1$$

$\therefore (1, 1)$ is the solution of the given equations

Ex (2) Solve. $3x - 4y = 16$; $2x - 3y = 10$

Solution : $3x - 4y = 16$(I)

$2x - 3y = 10$(II)

Writing x in terms of y from equation (I).

$$3x - 4y = 16$$

$$3x = 16 + 4y$$

$$x = \frac{16 + 4y}{3}$$

Substituting this value of x in equation (II)

$$2x - 3y = 10$$

$$2\left(\frac{16 + 4y}{3}\right) - 3y = 10$$

$$\frac{32 + 8y}{3} - 3y = 10$$

$$\frac{32 + 8y - 9y}{3} = 10$$

$$32 + 8y - 9y = 30$$

$$32 - y = 30 \quad \therefore y = 2$$

Now, substituting $y = 2$ in equation (I)

$$3x - 4y = 16$$

$$\therefore 3x - 4 \times 2 = 16$$

$$\therefore 3x - 8 = 16$$

$$\therefore 3x = 16 + 8$$

$$\therefore 3x = 24$$

$$\therefore x = 8$$

$$\therefore x = 8 \text{ and } y = 2$$

$\therefore (8, 2)$ is the solution of the given equations.

Practice set 5.1

- (1) By using variables x and y form any five linear equations in two variables.
- (2) Write five solutions of the equation $x + y = 7$.
- (3) Solve the following sets of simultaneous equations.

(i) $x + y = 4$; $2x - 5y = 1$	(ii) $2x + y = 5$; $3x - y = 5$
(iii) $3x - 5y = 16$; $x - 3y = 8$	(iv) $2y - x = 0$; $10x + 15y = 105$
(v) $2x + 3y + 4 = 0$; $x - 5y = 11$	(vi) $2x - 7y = 7$; $3x + y = 22$



Let's learn.

Word problems based on simultaneous equations

While solving word problems, converting the given information into mathematical form is an important step in this process. In the following flow-chart, the procedure for finding solutions of word problems is given.

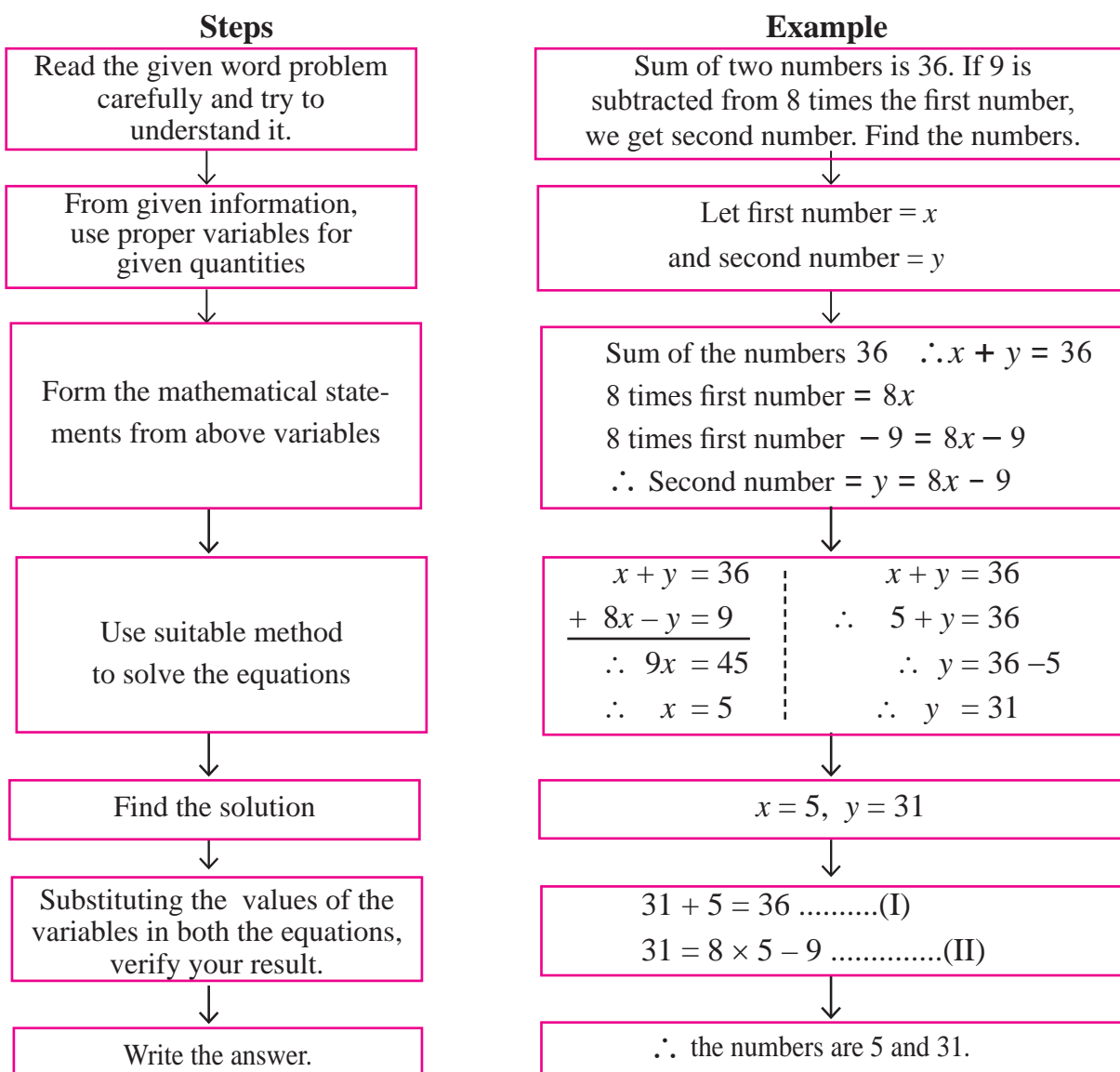

Word Problems

Now we will see various types of word problems.

- (1) Problems regarding age.
- (2) Problems regarding numbers.
- (3) Problems based on fractions.
- (4) Problems based on money transactions.
- (5) Problems based on geometrical properties
- (6) Problems based on speed, distance, time.

Ex (1) Sum of two numbers is 103. If greater number is divided by smaller number then the quotient is 2 and the remainder is 19. Then find the numbers.

Solution : Step 1 : To understand the given problem.

Step 2 : Use proper variables for given quantities. Also note the rule
dividend = divisor \times quotient + remainder.

Let the greater number be x and the smaller number be y

Step 3 : Given information : Sum of the numbers = 103

$x + y = 103$ is the first equation.

By dividing greater number by smaller numbers quotient is 2
and remainder is 19.

$x = 2 \times y + 19$...(dividend = divisor \times quotient + remainder)

$x - 2y = 19$ is the second equation.

Step 4 : Let us find the solution of the equations.

$$x + y = 103 \quad \text{.....(I)}$$

$$x - 2y = 19 \quad \text{.....(II)}$$

Subtracting eqn. (II) from eqn. (I)

$$\begin{array}{r} x + y = 103 \\ x - 2y = 19 \\ \hline - \quad + \quad - \\ \hline 0 + 3y = 84 \\ \therefore y = 28 \end{array}$$

Step 5 : Substituting value of y in equation $x + y = 103$.

$$\therefore x + 28 = 103$$

$$\therefore x = 103 - 28$$

$$\therefore x = 75$$

Step 6 : Given numbers are 75 and 28.

Ex (2) Salil's age is 23 years more than half of the Sangram's age. Five years ago, the sum of their ages was 55 years. Find their present ages.

Solution : Let Salil's present age be x and Sangram's present age be y .

Salil's age is 23 years more than half of the Sangram's age $\therefore x = \frac{y}{2} + \square$

Five years ago Salil's age = $x - 5$. Five years ago Sangram's age = $y - 5$

The sum of their ages five years ago = 55

$$\square + \square = 55$$

Finding the solution by solving equations

$$2x = y + 46 \qquad 2x - y = 46 \dots\dots\dots(I)$$

$$(x - 5) + (y - 5) = 55$$

$$x + y = 65 \qquad \dots\dots\dots(II)$$

Adding equation (I) and (II)

$$\begin{array}{r} 2x - y = 46 \\ + \quad x + y = 65 \\ \hline \end{array}$$

$$\therefore 3x = 111$$

$$\therefore x = 37$$

Substituting $x = 37$ in equation (II)

$$x + y = 65$$

$$\therefore 37 + y = 65$$

$$\therefore y = 65 - 37$$

$$\therefore y = 28$$

Salil's present age is 37 years and Sangram's present age is 28 years.

Ex (3) A two digit number is 4 times the sum of its digits. If we interchange the digits, the number obtained is 9 less than 4 times the original number. Then find the number.

Solution : Let the units place digit in original number be x , and tens place be y .

	Digit in tens place	Digit in units place	Number	Sum of the digits
For original number	y	x	$10y + x$	$y + x$
Number obtained by interchanging the digits	x	y	$10x + y$	$x + y$

From first condition, $10y + x = 4(y + x)$

$$\therefore 10y + x = 4y + 4x$$

$$\therefore x - 4x + 10y - 4y = 0$$

$$\therefore -3x + 6y = 0 \quad \therefore -3x = -6y \qquad \therefore x = 2y \quad \dots\dots(I)$$

$$\begin{aligned}
\text{From second condition, } 10x + y &= 2(10y+x)-9 \\
10x+y &= 20y + 2x-9 \\
10x-2x+y-20y &= -9 \\
8x - 19y &= -9 && \text{.....(II)} \\
x &= 2y && \text{.....(I)}
\end{aligned}$$

Substituting $x = 2y$ in equation (II).

$$\begin{aligned}
16y - 19y &= -9 && \text{.....(I)} \\
\therefore -3y &= -9 \\
\therefore y &= 3
\end{aligned}$$

Substituting $y = 3$ in equation (I).

$$\begin{aligned}
x - 2y &= 0 \\
x - 2 \times 3 &= 0 && \therefore x - 6 = 0 && \therefore x = 6
\end{aligned}$$

$$\begin{aligned}
\text{Original two digit number : } 10y + x &= 10 \times 3 + 6 \\
&= 36
\end{aligned}$$

Ex (4) The population of a certain town was 50,000. In a year, male population was increased by 5% and female population was increased by 3%. Now the population became 52020. Then what was the number of males and females in the previous year?

Solution : Let the number of males in previous year be x , number of females be y .

$$\text{By first condition } \square + \square = 50000 \text{(I)}$$

$$\text{Male population increased by 5\% } \therefore \text{ number of males} = \frac{\square}{\square} x$$

$$\text{Female population increased by 3\% } \therefore \text{ number of females} = \frac{\square}{\square} y.$$

$$\text{From second condition } \frac{\square}{\square} x + \frac{\square}{\square} y = 52020$$

$$\square x + \square y = 5202000 \text{(II)}$$

Multiplying equation (I) by 103

$$\square x + \square y = 5150000 \text{(III)}$$

Subtracting equation (III) from equation (II) .

$$2x = 5202000 - 5150000$$

$$2x = 52000$$

$$\therefore \text{ number of males} = x = \square \quad \therefore \text{ number of females} = y = \square$$

Activity I : There are instructions written near the arrows in the following diagram. From this information form suitable equations and write in the boxes indicated by arrows. Select any two equations from these boxes and find their solutions. Also verify the solutions. By taking one pair of equations at a time, how many pairs can be formed ? Discuss the solutions for these pairs.

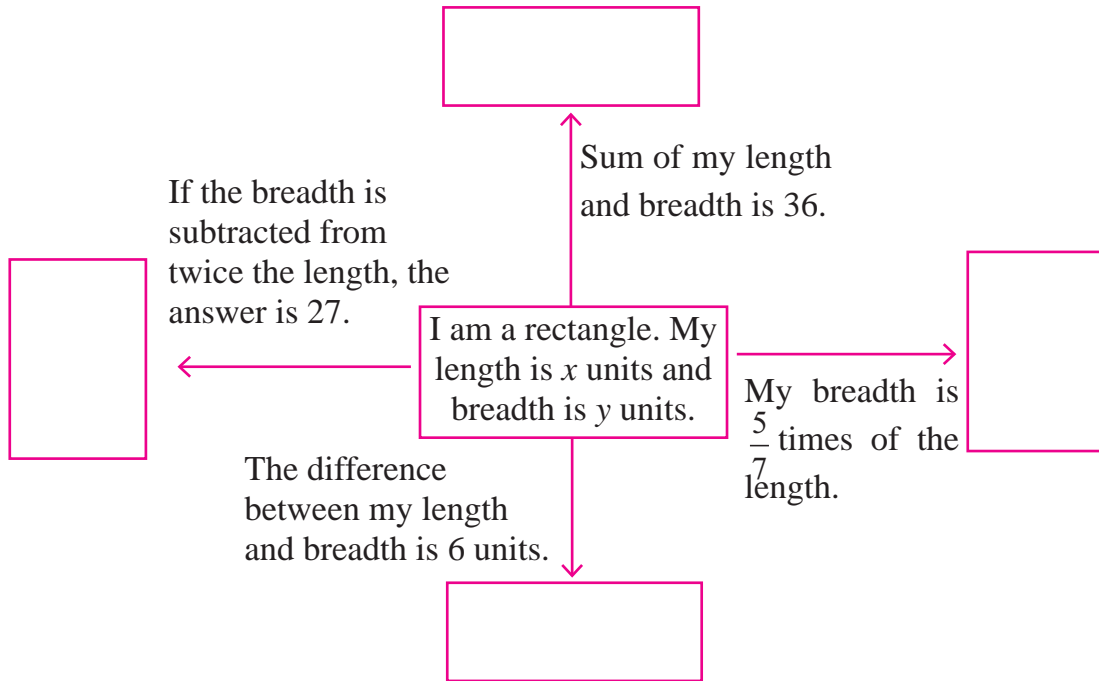

Practice set 5.2

- (1) In an envelope there are some 5 rupee notes and some 10 rupee notes. Total amount of these notes together is 350 rupees. Number of 5 rupee notes are less by 10 than number of 10 rupee notes. Then find the number of 5 rupee and 10 rupee notes.
- (2) The denominator of a fraction is 1 less than twice its numerator. If 1 is added to numerator and denominator respectively, the ratio of numerator to denominator is 3 : 5. Find the fraction.
- (3) The sum of ages of Priyanka and Deepika is 34 years. Priyanka is elder to Deepika by 6 years. Then find their today's ages.
- (4) The total number of lions and peacocks in a certain zoo is 50. The total number of their legs is 140. Then find the number of lions and peacocks in the zoo.
- (5) Sanjay gets fixed monthly income. Every year there is a certain increment in his salary. After 4 years, his monthly salary was Rs. 4500 and after 10 years his monthly salary became 5400 rupees, then find his original salary and yearly increment.
- (6) The price of 3 chairs and 2 tables is 4500 rupees and price of 5 chairs and 3 tables is 7000 rupees, then find the total price of 2 chairs and 2 tables.

- (7) The sum of the digits in a two-digits number is 9. The number obtained by interchanging the digits exceeds the original number by 27. Find the two-digit number.
- (8*) In $\triangle ABC$, the measure of angle A is equal to the sum of the measures of $\angle B$ and $\angle C$. Also the ratio of measures of $\angle B$ and $\angle C$ is 4 : 5. Then find the measures of angles of the triangle.
- (9*) Divide a rope of length 560 cm into 2 parts such that twice the length of the smaller part is equal to $\frac{1}{3}$ of the larger part. Then find the length of the larger part.
- (10) In a competitive examination, there were 60 questions. The correct answer would carry 2 marks, and for incorrect answer 1 mark would be subtracted. Yashwant had attempted all the questions and he got total 90 marks. Then how many questions he got wrong ?

Problem set 5

- (1) Choose the correct alternative answers for the following questions.
- (i) If $3x + 5y = 9$ and $5x + 3y = 7$ then What is the value of $x + y$?
 (A) 2 (B) 16 (C) 9 (D) 7
- (ii) 'When 5 is subtracted from length and breadth of the rectangle, the perimeter becomes 26.' What is the mathematical form of the statement ?
 (A) $x - y = 8$ (B) $x + y = 8$ (C) $x + y = 23$ (D) $2x + y = 21$
- (iii) Ajay is younger than Vijay by 5 years. Sum of their ages is 25 years. What is Ajay's age ?
 (A) 20 (B) 15 (C) 10 (D) 5
- (2) Solve the following simultaneous equations.
- (i) $2x + y = 5$; $3x - y = 5$ (ii) $x - 2y = -1$; $2x - y = 7$
 (iii) $x + y = 11$; $2x - 3y = 7$ (iv) $2x + y = -2$; $3x - y = 7$
 (v) $2x - y = 5$; $3x + 2y = 11$ (vi) $x - 2y = -2$; $x + 2y = 10$
- (3) By equating coefficients of variables, solve the following equations.
- (i) $3x - 4y = 7$; $5x + 2y = 3$ (ii) $5x + 7y = 17$; $3x - 2y = 4$
 (iii) $x - 2y = -10$; $3x - 5y = -12$ (iv) $4x + y = 34$; $x + 4y = 16$
- (4) Solve the following simultaneous equations.
- (i) $\frac{x}{3} + \frac{y}{4} = 4$; $\frac{x}{2} - \frac{y}{4} = 1$ (ii) $\frac{x}{3} + 5y = 13$; $2x + \frac{y}{2} = 19$
 (iii) $\frac{2}{x} + \frac{3}{y} = 13$; $\frac{5}{x} - \frac{4}{y} = -2$

- (5*) A two digit number is 3 more than 4 times the sum of its digits. If 18 is added to this number, the sum is equal to the number obtained by interchanging the digits. Find the number.
- (6) The total cost of 8 books and 5 pens is 420 rupees and the total cost of 5 books and 8 pens is 321 rupees. Find the cost of 1 book and 2 pens.
- (7*) The ratio of incomes of two persons is 9 : 7. The ratio of their expenses is 4 : 3. Every person saves rupees 200, find the income of each.
- (8*) If the length of a rectangle is reduced by 5 units and its breadth is increased by 3 units, then the area of the rectangle is reduced by 8 square units. If length is reduced by 3 units and breadth is increased by 2 units, then the area of rectangle will increase by 67 square units. Then find the length and breadth of the rectangle.
- (9*) The distance between two places A and B on road is 70 kilometers. A car starts from A and the other from B. If they travel in the same direction, they will meet after 7 hours. If they travel towards each other they will meet after 1 hour, then find their speeds.
- (10*) The sum of a two digit number and the number obtained by interchanging its digits is 99. Find the number.

Activity : Find the fraction.

$$\frac{\text{Numerator } x}{\text{Denominator } y}$$

If numerator is multiplied by 3 and 3 is subtracted from the denominator then the fraction obtained is $\frac{18}{11}$.

Equation I

$$11x - 6y + 18 = 0$$

If numerator is increased by 8 and denominator is doubled then the resulting fraction is $\frac{1}{2}$.

Equation II

$$x - y + 8 = 0$$

$$\therefore \text{ Given fraction} = \frac{\square}{\square}$$

Verify the answer obtained.



6

Financial Planning



Let's study.

- Introduction to financial planning
- Tax structure
- Savings and Investments
- Computation of Income -tax



Let's discuss.

Anagha : Shall we buy computer ?
 Mother : Ok, let's buy it next year.
 Anagha : Mamma, why not now ?
 Mother : Anagha, you don't know how expensive it is !
 Anagha : You mean we will have to save up for it, right ?
 Mother : Yes, thats the thing.



We often hear such conversations.

Everyone requires money to meet a variety of needs. That is why after spending on the necessities of the present, everyone tries to save money to make provisions for the future needs. That is what we call 'Saving' money. In order to protect our savings or even to make them grow, we keep them as fixed deposits or buy immovable properties such as a house, land etc. That is what we call 'investment'.

Every investor, first spends the amount required to meet primary necessities and saves the remaining amount. One also uses these savings to make a carefully considered investments. This is called **financial planning**. The main purpose of financial planning is protection and growth of the wealth.

Financial planning is useful for making provisions for the predictable and unpredictable expenses that each of us has to meet in our life.

Predictable expenses	Unpredictable expenses
(1) Education of children and other expenses for them	(1) Natural disasters
(2) Capital for a profession or business	(2) Medical expenses for a family member.
(3) Buying a vehicle	(3) Loss due to an accident
(4) Buying or building a house.	(4) Sudden death
(5) Old age requirements.	

The above considerations make it quite clear why financial planning is a must. However some important points must be kept in mind as we plan our finances.



Let's learn.

Savings

(1) It is for our own benefit to keep our savings safe and to make them grow. Our savings remain safe in a bank or in a post office. Money saved in a bank is also useful for cashminus transactions. This way, we do not have to carry large amounts of cash or worry about losing it or getting it stolen.

(2) If the money we get or earn is in the form of cash and we keep it as it is, without investing it, its value diminishes with time. For example, if today your can buy two pencils for ten rupees, a few years hence, you may be able to buy only one for that amount.

(3) If the amount invested is used for expanding a business, to start an industry or other such purposes, it contributes to the growth of the national production.

(4) If some part of the income is spent for a socially useful cause everyone benefits from it in the long run.

(5) After spending on necessities it is beneficial to limit spending on luxuries and to save, instead for education, medical treatment etc.



Let's discuss.



Observe the above picture, which shows some modes of investment. Discuss them. Find out other modes of investment and write them in the blank spaces in the picture.



Let's learn.

Investments

Investments are of many types. Investors often favour institutions like banks and postal departments for investing their money because it is safe there. There is a certain risk in investing money in shares, mutual funds, etc. That is because this money is invested in a business or industry and if that incurs a loss, the investor suffers the loss too. On the other hand, if it makes a profit the money is safe and there is the opportunity to get a dividend too.

An investor must take two important points into account when making an investment namely the risk and the gain. It is possible to make big gains by taking greater risk. However it must be kept in mind that the greater risk can also lead to greater loss.

Study the following examples based on income and investment.

Ex(1) Shamrao's income in 2015-16 after paying all taxes is Rs. 6,40,000 . He pays Rs. 2000 per month for insurance and 20% of his annual income into his provident fund. He puts aside Rs. 500 per month for emergencies. How much money does he have for yearly spending ?

Solution : (i) Annual income = 6,40,000 rupees

(ii) Insurance premium = $2000 \times 12 = 24,000$ rupees

(iii) Contribution to provident fund = $6,40,000 \times \frac{20}{100} = 1,28,000$ rupees

(iv) Amount put aside for emergency = $500 \times 12 = 6000$ rupees

\therefore Total planned expenditure = $24,000 + 1,28,000 + 6,000 = 1,58,000$ rupees

\therefore Amount available for yearly expenses = $6,40,000 - 1,58,000 = 4,82,000$ rupees

Ex(2) Mr. Shah invested Rs. 3,20,000 in a bank at 10% compound interest . He also invested Rs. 2,40,000 in mutual funds. At market rates he got Rs. 3,05,000 after 2 years. How much did he gain ? Which of his investments was more profitable ?

Solution : (i) We shall first calculate the compound interest on the money invested in the bank.

Compound interest = Amount - Principal

That is, $I = A - P$

$$= P \left(1 + \frac{r}{100} \right)^n - P$$

$$= P \left[\left(1 + \frac{r}{100} \right)^n - 1 \right]$$

$$= 3,20,000 \left[\left(1 + \frac{10}{100} \right)^2 - 1 \right]$$

$$\begin{aligned}
&= 3,20,000 \left[(1.1)^2 - 1 \right] \\
&= 3,20,000 [1.21 - 1] \\
&= 3,20,000 \times 0.21 \\
&= 67,200 \text{ rupees}
\end{aligned}$$

Mr. Shah invested Rs. 3,20,000 in the bank and got Rs. 67,200 as interest.

Let us see percentage of interest obtained on the investment.

$$\text{Percentage of interest} = \frac{100 \times 67200}{3,20,000} = 21$$

∴ The investment in the bank gave a profit of 21%.

(ii) The amount Mr. Shah got at the end of 2 years from the mutual fund = 3,05,000 rupees

∴ The gain from the mutual fund = 3,05,000 – 2,40,000 = 65,000 rupees

$$\therefore \text{Percentage gain} = \frac{65000 \times 100}{2,40,000} = 27.08$$

The investment in the mutual fund yielded a profit of 27.08% .

It is clear that Mr. Shah's investment in the mutual fund was more profitable.

Ex(3) Mr. Shaikh invested Rs. 4,00,000 in a glass industry. After 2 years he received Rs. 5,20,000 from the industry. Putting aside the original investment, he invested his gains in a fixed deposit and in shares in the ratio 3 : 2. How much amount did he invested originally in each of the schemes ?

Solution : Mr. Shaikh's profit at the end of 2 years = 5,20,000 – 4,00,000 = 1,20,000 rupees

$$\begin{aligned}
\text{Amount invested in the fixed deposit} &= \frac{3}{5} \times 1,20,000 \\
&= 3 \times 24,000 \\
&= 72,000 \text{ rupees}
\end{aligned}$$

$$\begin{aligned}
\text{Amount invested in shares} &= \frac{2}{5} \times 1,20,000 \\
&= 2 \times 24,000 \\
&= 48,000 \text{ rupees}
\end{aligned}$$

Mr. Shaikh invested 72000 rupees in the fixed deposit and 48,000 rupees in shares.

Ex(4) The ratio of Mr. Anil's monthly income to expenditure is 5 : 4,. For Mr. Aman the same figure is 3 : 2. Also, 4% of Aman's monthly income is equal to 7% of Anil's monthly income. If Anil's monthly expenditure is 96,000 rupees-

(i) Find Aman's annual income. (ii) Savings made by Mr. Anil and Mr. Aman.

Solution: We know that savings = Income – Expenditure

Anil's income to expenditure 5 : 4

Aman's income to expenditure 3 : 2

Suppose Anil's income is $5x$.

Suppose Aman's income is $3y$.

Anil's expenditure is $4x$

Aman's expenditure is $2y$

Anil's monthly income is 9600 rupees,

$$\therefore 5x = 9600$$

$$x = 1920$$

Monthly expenditure = $4x = 4 \times 1920 = 7680$ rupees.

Anil's monthly expenditure is 7680 rupees. \therefore Anil's saving is 1920 rupees.

4% of Aman's income = 7% of Anil's income

$$\therefore \frac{4}{100} \times 3y = 9600 \times \frac{7}{100}$$

$$\therefore 12y = 9600 \times 7$$

$$\therefore y = \frac{9600 \times 7}{12} = 5600$$

Aman's income = $3y = 3 \times 5600 = 16,800$ rupees

Aman's expenditure = $2y = 2 \times 5600 = 11,200$ rupees

\therefore Aman's savings = $16,800 - 11,200 = 5,600$ rupees

Aman's monthly income is Rs. 16,800 and Aman's saving is Rs. 5,600

Anil's monthly saving is 1,920 rupees.

Activity I : Amita invested some part of 35000 rupees at 4% and the rest at 5% interest for one year. Altogether her gain was Rs. 1530. Find out the amounts she had invested at the two different rates. Write your answer in words.

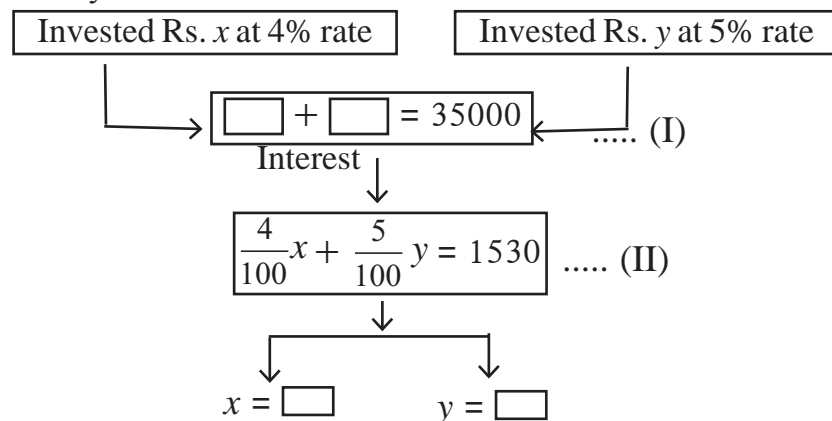

Activity: (1) With your parent's help write down the income and expenditure of your family for one week. Make 7 columns for the seven days of the week. Write all expenditure under such heads as provisions, education, medical expenses, travel, clothes and miscellaneous. On the credit side write the amount received for daily expenses, previous balance and any other new income.

(2) In the holidays, write the accounts for the whole month.

Activity II : Study the Income Expenditure of Govind on page no.52 Discuss the methods a farmer may use who does dry land farming to enhance his income. Some students have expressed their opinions.

Sohil : Farmers get money only when they sell their produces. This profit must be sufficient to sustain for the whole year. So, financial planning is very important for him.

Prakash : His income will increase if agricultural products gets a reasonable price.

Nargis : A law of economics states that if the supply of a commodity far exceeds its demand then its price falls. Naturally profits will also be reduced.

Rita : If the farm production is in excess and if there is a fear of fall in prices, it can be stocked and sent to the market only when prices recover again.

Azam : For that, we need good warehouses.

Reshma : Credit should be easily available to farmers at low rates of interest.

Vatsala : Other farm based businesses like dairy and poultry can provide additional income. Besides, dung and urine obtained from farm animals, can also provide good quality manure.

Kunal : If then start agro-processing units and make preserves like squashes, jams, pickles, pulps or dried vegetables they could sell these packed products all the year round. They could even start producing more of those tins which can be exported.

Practice set 6.1

1. Alka spends 90% of the money that she receives every month, and saves Rs. 120. How much money does she get monthly ?
2. Sumit borrowed a capital of Rs. 50,000 to start his food products business. In the first year he suffered a loss of 20%. He invested the remaining capital in a new sweets business and made a profit of 5%. How much was his profit or loss computed on his original capital ?
3. Nikhil spent 5% of his monthly income on his children's education, invested 14% in shares, deposited 3% in a bank and used 40% for his daily expenses. He was left with a balance of Rs. 19,000. What was his income that month ?
4. Mr. Sayyad kept Rs. 40,000 in a bank at 8% compound interest for 2 years. Mr. Fernandes invested Rs. 1,20,000 in a mutual fund for 2 years. After 2 years, Mr. Fernandes got Rs. 1,92,000. Whose investment turned out to be more profitable ?
5. Sameera spent 90% of her income and donated 3% for socially useful causes. If she left with Rs. 1750 at the end of the month, what was her actual income ?

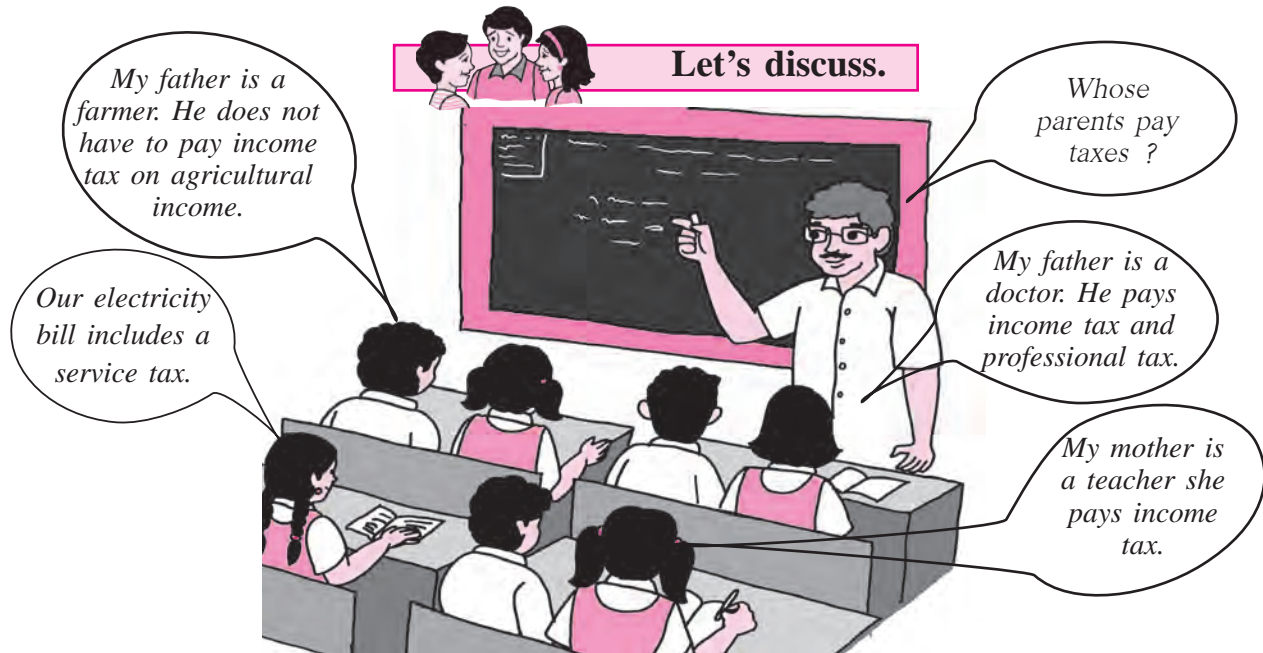

What is a tax ? Which are different types of taxes ? Find out more information on following websites.

ICT Tools or Links
www.incometaxindia.gov.in,
 www.mahavat.gov.in,
 www.gst.gov.in

Let's learn.

Levying of taxes or Taxation

The government makes many plans for the development of the country. It requires large amounts of money for implementing these schemes. By charging different types of taxes the funds are generated for implementation of these schemes.

Utility of taxes

- Provision of infrastructure / basic amenities.
- Implementing various welfare schemes.
- Implementing schemes of development and research in various fields.
- Maintaining law and order.
- Giving aid to people affected by natural disasters.
- Defence of the country and its citizens etc.

Types of taxes

Direct taxes	Indirect taxes
Taxes which are paid directly by the taxpayer are called direct taxes. Examples : Income tax, wealth tax, professional tax, etc.	Taxes which are not paid directly by the taxpayer are called indirect taxes Examples : Central sales tax, value added tax, service tax, excise duty, customs duty, etc.

The types of taxes listed above are in accordance with the existing tax structure.
Project : Obtain more information about different types of taxes from employees and professionals who pay taxes.



Let's learn.

Income tax

If the income earned in India by an individual, institute or authorised industry exceeds the limit specified under the Income Tax Act, income tax is levied on it. In this chapter, we shall consider only those taxes which are to be paid by individuals. Income tax is levied by the central Government in India, income tax is levied under following two acts.

- (1) Income Tax Act 1961 which came into force on. 01.04.1962.
- (2) The act passed every year by parliament which makes financial provisions.

Every year sometime in February the finance Minister presents the budget for the next financial year. It has proposals for the income tax rates. Once parliament passes the budget the proposed rates become applicable in the following year.

Income tax rates are fixed every year in the budget.

Some Income tax related terms :

- **An assessee** : Any person liable to pay income tax according to the Income Tax Rules is termed an assessee.
- **Financial year** : The period of one year during which the taxable income has been earned is called a financial year. In our country, at present, the financial year is from 1st April to 31st March.
- **Assessment year** : The financial year immediately following a particular financial year is called the assessment year. The tax payable for the previous financial year is calculated during the current year. i.e. the assessment year.

Financial year and Assessment year will be clear from the table below.

Financial Year	Assessment Year
2016-17 : 01-04-2016 to 31-03-2017	2017-18
2017-18 : 01-04-2017 to 31-03-2018	2018-19

- **Permanent Account Number (PAN)** : On applying for it, every tax-payer gets a unique ten digit alphanumeric number from the Income Tax Department. (PAN). We are required to mention this number in many important documents and financial transactions.

Use of the PAN : It is binding to write our PAN on the challan used for paying our income tax to the IT Department or our Income Tax Returns and other official correspondence. PAN card can also be used as a proof of identity.





Let's learn.

Computation of income tax

As income tax is a tax levied on income, it is necessary to know about the different sources of income.

There are five main heads of income.

- | | |
|--|--------------------------------|
| (1) Income from salary | (2) Income from house/property |
| (3) Income from business or profession | (4) Income from Capital gain |
| (5) Income from other sources | |

Important considerations for computing the income tax payable by a salaried employee :

The total annual income (Gross Total Income) is taken into account for calculating the tax payable. According to the sections 80C, 80D, 80G etc. of the Income Tax Act some deductions can be availed from the total annual income. The amount remaining after these deductions are made, is called taxable income. Income tax is levied on this taxable income.

Every year, the rules for computing income tax are changed. Hence, it is important to know the latest rules when actually calculating the tax payable.

No tax is levied up to a certain limit of taxable income. This is called the basic exemption limit.

- Farmer's income from agricultural produce is exempt from taxation.
- Under section 80 G of IT Act donations to the Prime Minister's relief fund, Chief Minister's Relief Fund and certain other donations recognized to institutions/ organizations are exempt from taxation.
- Under section 80 D, installments of premium for health insurance are exempt from taxation.
- Generally, the maximum premissible deduction to various kinds of savings under section 80C is Rs. 1,50,000.

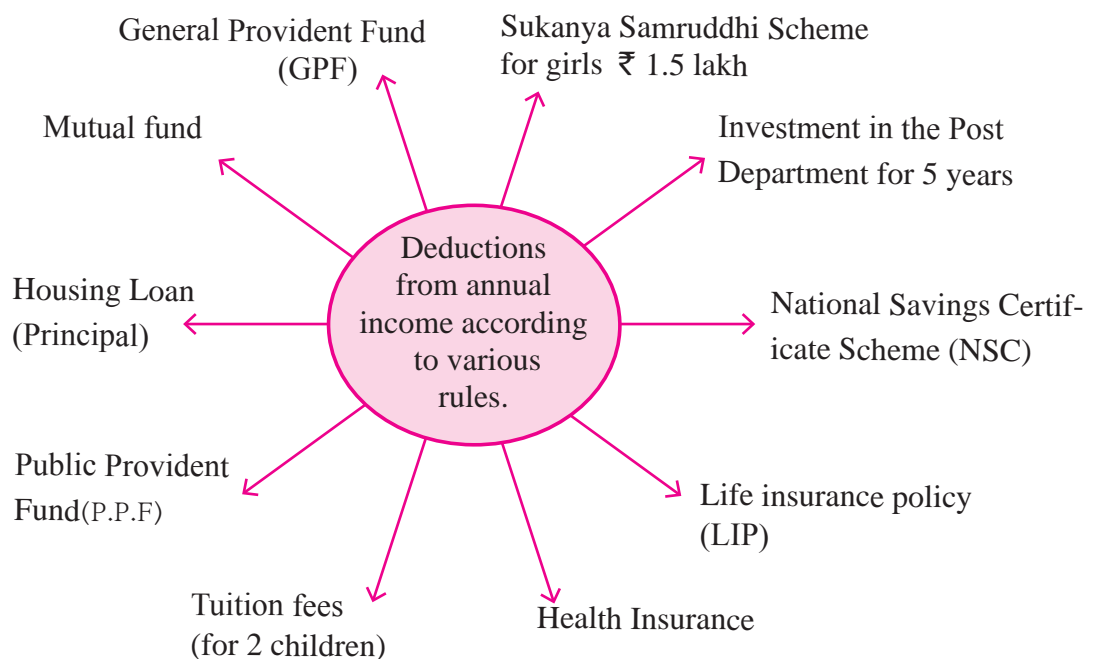

Tax rates according to age of taxpayers are fixed in each year's budget. Samples of tables showing tax rates for different income slabs are given below.

Table I

Individuals (up to the age of 60 years)			
Taxable Income slabs (In Rupees)	Income Tax	Education cess	Secondary and Higher Educa- tion cess
Up to 2,50,000	Nil	Nil	Nil
2,50,001 to 5,00,000	5% (On taxable income minus two lakh fifty thousand)	2% of Income tax	1% of Income tax
5,00,001 to 10,00,000	₹ 12,500 + 20% (On taxable income minus five lakh)	2% of Income tax	1% of Income tax
More than 10,00,000	₹ 1,12,500 + 30% (On taxable income minus ten lakh)	2% of Income tax	1% of Income tax
(Surcharge equal to 10% of income tax payable by individuals having an annual income of 50 lakh to one crore rupees and 15% of income tax by individuals having an annual income greater than one crore rupees)			

Activity : Use Table I given above and write the appropriate amount/figure in the boxes for the example given below.

Ex. Mr. Mehta's annual income is Rs. 4,50,000

- If he does not have any savings by which he can claim deductions from his income, to which slab does his taxable income belong ?
- What is the amount on which he will have to pay income tax and at what percent rate ?
on ₹ percentage
- On what amount will the cess be levied ?

Table II

Senior citizens (Age 60 to 80 years)			
Taxable Income slabs (In Rupees)	Income Tax	Education cess	Secondary and Higher Educa- tion cess
Upto 3,00,000	Nil	Nil	Nil
3,00,001 to 5,00,000	5% (On taxable income minus three lakh)	2% of Income tax	1% of Income tax
5,00,001 to 10,00,000	₹ 10,000 + 20% (On taxable income minus five lakh)	2% of Income tax	1% of Income tax
More than 10,00,000	₹ 1,10,000 + 30% (On taxable income minus ten lakh)	2% of Income tax	1% of Income tax
(Surcharge equal to 10% of income tax payable by individuals having an annual income of 50 lakh to one crore rupees and 15% of income tax by individuals having an annual income greater than one crore rupees)			

Activity : Use table II to carry out the following activity

Ex. Mr. Pandit is 75 years of age. Last year his annual income was 13,25,000 rupees. How much is his taxable income ? How much tax does he have to pay ?

$$13,25,000 - 10,00,000 = 3,25,000$$

According to the table he must first pay Rs. 1,10,000 as income tax. In addition, on 3,25,000 rupees he has to pay 30% income tax.

$$3,25,000 \times \frac{30}{100} = \boxed{} \text{ rupees.}$$

Therefore, his total income tax amounts to $\boxed{} + \boxed{} = \boxed{}$

Besides this, education cess will be 2% of income tax $\boxed{} \times \frac{2}{100} = \boxed{}$.

A secondary and higher education cess at 1% of income tax = $\boxed{} \times \frac{1}{100} = \boxed{}$

\therefore Total income tax = Income tax + education cess + secondary and higher education cess.

$$\begin{aligned} &= \boxed{} + \boxed{} + \boxed{} \\ &= \boxed{\text{₹ 2,13,725}} \end{aligned}$$

Table III

Super senior citizens (Age above 80 years)			
Taxable Income slabs (In Rupees)	Income Tax	Education cess	Secondary and Higher Education cess
Upto 5,00,000	Nil	Nil	Nil
5,00,001 to 10,00,000	20% (On taxable income minus five lakh)	2% of Income tax	1% of Income tax
More than 10,00,000	₹ 1,00,000 + 30% (On taxable income minus ten lakh)	2% of Income tax	1% of Income tax

(Surcharge equal to 10% of income tax payable by individuals having an annual income of 50 lakh to one crore rupees and 15% of income tax by individuals having an annual income greater than one crore rupees)

Project : Obtain information about sections 80C, 80G, 80D of the Income Tax Act.

Study a PAN card and make a note of all the information it contains..

Obtain information about all the devices and means used for carrying out cash minus transactions.

From the following solved examples we will learn how the tables given and the deductions available to individuals are used to compute income tax.

Ex(1) Mr. Mhatre is 50 years old. His gross total income is Rs. 12,00,000. He has invested in the following amounts in different schemes.

- (i) Insurance premium : ₹ 90,000 (ii) Investment in provident fund : ₹ 25,000
 (iii) Investment in PPF : ₹ 15,000 (iv) National Savings Certificate : ₹ 20,000

Find out the permissible deductions, taxable income, and the income tax payable.

Solution : (1) Total Yearly income = 12,00,000 rupees.

(2) Total savings under section 80C.

Savings	Amount of Savings (rupees)
(i) Insurance premium	90,000
(ii) Provident Fund	25,000
(iii) Public Provident Fund	15,000
(iv) National Savings Certificate	20,000
Total	1,50,000

According to section 80C, a maximum deduction of Rs. 1,50,000 is permissible.

(3) ∴ Taxable Income = Amount in [1] – Amount in [2]

$$= 12,00,000 - 1,50,000 = 10,50,000$$

(4) We shall use Table I to calculate Mr. Mhatre's total income tax .

Mr. Mhatre's taxable income = ₹ 10,50,000 which is greater than ten lakh rupees.

∴ According to Table (I) Income tax = ₹ 1,12,500 + 30% (of total income minus 10 lakh)

$$∴ 10,50,000 - 10,00,000 = 50,000$$

$$∴ \text{Income tax} = 1,12,500 + 50,000 \times \frac{30}{100}$$

$$= 1,12,500 + 15,000$$

$$= 1,27,500$$

We must also include 2% education cess and 1% secondary and higher education cess.

$$\text{Education cess} = 1,27,500 \times \frac{2}{100} = 2550 \text{ rupees}$$

$$\text{Secondary and higher education cess} = 1,27,500 \times \frac{1}{100} = 1275 \text{ rupees}$$

$$∴ \text{Total income tax} = 1,27,500 + 2550 + 1275 = 1,31,325 \text{ rupees}$$

Mr. Mhatre's tax payable = ₹ 1,31,325

Ex(2) Mr. Ahmed, a 62 year old senior citizen is employed in a private company. His total annual income is Rs.6,20,000. He has contributed Rs. 1,00,000 to the Public Provident Fund and paid a premium of Rs. 80,000 for the year for health insurance and a donation of Rs. 10,000 to CM's Relief Fund. What is tax payable ?

Solution : (1) Total Yearly income = 6,20,000 rupees

(2) Total deduction (According to 80C)

(i) Public Provident Fund = 1,00,000 rupees

(ii) Insurance = 80,000 rupees

1,80,000 rupees

(iii) Section 80C permits a maximum deduction of Rs. 1,50,000 rupees.

(3) Amt. given to CM's Relief Fund (According to 80 G) = 10000 rupees.

(4) Taxable income = (1) – [(2) + (3)]
 = 6,20,000 – [1,50,000 + 10000]
 = 4,60,000 rupees

From table II we see that the taxable income is in the slab 3 lakh to 5 lakh rupees.

$$\begin{aligned} \therefore \text{Income tax} &= (\text{Taxable income} - 3,00,000) \times \frac{5}{100} \\ &= (4,60,000 - 3,00,000) \times \frac{5}{100} \\ &= 1,60,000 \times \frac{5}{100} \\ &= 8000 \text{ rupees} \end{aligned}$$

Education cess is levied on income tax.

$$\text{Education cess} = 8,000 \times \frac{2}{100} = 160$$

$$\text{Secondary and higher education cess} : 8,000 \times \frac{1}{100} = 80$$

$$\therefore \text{Total Income tax} = 8000 + 160 + 80 = ₹ 8,240$$

\therefore tax payable by Mr. Ahmed is ₹ 8,240.

Ex(3) Mrs. Hinduja's age is 50 years. Last year her taxable income was Rs. 16,30,000. How much income tax has she to pay ?

Solution : Mrs Hinduja's taxable income is in the bracket of Rs. 10,00,000 and above.

Let us use Table I to compute her income tax. Accordingly, for income greater than Rs. 10,00,000.

$$\text{Income tax} = \text{Rs. } 1,12,500 + 30\% \text{ of total income minus ten lakh}$$

$$\begin{aligned}\text{Mrs. Hinduja's income minus ten lakh} &= 16,30,000 - 10,00,000 \\ &= 6,30,000 \text{ rupees}\end{aligned}$$

From table I

$$\begin{aligned}\text{Income tax} &= 1,12,500 + 6,30,000 \times \frac{30}{100} \\ &= 1,12,500 + 30 \times 6,300 \\ &= 1,12,500 + 1,89,000 \\ &= 3,01,500 \text{ rupees}\end{aligned}$$

On this we compute

$$1\% \text{ secondary and higher education cess} = \frac{1}{100} \times 3,01,500 = ₹ 3015$$

$$2\% \text{ education cess} = \frac{2}{100} \times 3,01,500 = ₹ 6030$$

$$\begin{aligned}\therefore \text{total income tax payable} &= 3,01,500 + 3015 + 6030 \\ &= 3,10,545\end{aligned}$$

\therefore total income tax payable is 3,10,545 rupees

Practice set 6.2

(1) Observe the table given below. Check and decide, whether the individuals have to pay income tax.

S. No.	Individuals	Age	Taxable Income (₹)	Will have to pay income tax or not
(i)	Miss Nikita	27	₹ 2,34,000	
(ii)	Mr. Kulkarni	36	₹ 3,27,000	
(iii)	Miss Mehta	44	₹ 5,82,000	
(iv)	Mr. Bajaj	64	₹ 8,40,000	
(v)	Mr. Desilva	81	₹ 4,50,000	

(2) Mr. Kartarsingh (age 48 years) works in a private company. His monthly income after deduction of allowances is Rs. 42,000 and every month he contributes Rs. 3000 to GPF. He has also bought Rs. 15,000 worth of NSC (National Savings Certificate) and donated Rs. 12,000 to the PM's Relief Fund. Compute his income tax.

Problem set 6

- (1) Write the correct alternative answer for each of the following questions.
 - (i) For different types of investments what is the maximum permissible amount under section 80C of income tax ?
(A) 1,50,000 rupees (B) 2,50,000 rupees (C) 1,00,000 rupees (D) 2,00,000 rupees
 - (ii) A person has earned his income during the financial year 2017-18. Then his assessment year is
(A) 2016-17 (B) 2018-19 (C) 2017-18 (D) 2015-16
- (2) Mr. Shekhar spends 60% of his income. From the balance he donates Rs. 300 to an orphanage. He is then left with Rs. 3,200. What is his income ?
- (3) Mr. Hiralal invested Rs. 2,15,000 in a Mutual Fund. He got Rs. 3,05,000 after 2 years. Mr. Ramniklal invested Rs. 1,40,000 at 8% compound interest for 2 years in a bank. Find out the percent gain of each of them. Whose investment was more profitable ?
- (4) At the start of a year there were Rs. 24,000 in a savings account. After adding Rs. 56,000 to this the entire amount was invested in the bank at 7.5% compound interest. What will be the total amount after 3 years ?
- (5) Mr. Manohar gave 20% part of his income to his elder son and 30% part to his younger son. He gave 10% of the balance as donation to a school. He still had Rs. 1,80,000 for himself. What was Mr. Manohar's income ?
- (6*) Kailash used to spend 85% of his income. When his income increased by 36% his expenses also increased by 40% of his earlier expenses. How much percentage of his earning he saves now ?
- (7*) Total income of Ramesh, Suresh and Preeti is 8,07,000 rupees. The percentages of their expenses are 75%, 80% and 90% respectively. If the ratio of their savings is 16 : 17 : 12, then find the annual saving of each of them.
- (8) Compute the income tax payable by following individuals.
 - (i) Mr. Kadam who is 35 years old and has a taxable income of Rs. 13,35,000.
 - (ii) Mr. Khan is 65 years of age and his taxable income is Rs. 4,50,000.
 - (iii) Miss Varsha (Age 26 years) has a taxable income of Rs. 2,30,000.



ICT Tools or Links

Visit www.incometaxindia.gov.in which is a website of the Government of India. Click on the 'incometax calculator' menu. Fill in the form that gets downloaded using an imaginary income and imaginary deductible amounts and try to compute the income tax payable for this income.

7

Statistics



Let's study.

- Sub-divided bar-diagram
- Percentage bar-diagram
- Primary and secondary data
- Grouped and ungrouped frequency distribution
- Cumulative frequency distribution
- Mean, Median and Mode for ungrouped data



Let's recall.

In earlier standards, we have learnt how to draw a simple bar-diagram and a joint bar-diagram. Also, we have observed various graphs from newspapers, magazines, television etc. and gathered information from them.

It is very important to decide according to the nature of the data, what diagram or graph would be suitable to represent it.

A farmer has produced Wheat and Jowar in his field. The following joint bar diagram shows the production of Wheat and Jowar. From the given diagram answer the following questions :

- (i) Which crop production has increased consistently in 3 years ?
- (ii) By how many quintals the production of Jowar has reduced in 2012 as compared to 2011?
- (iii) What is the difference between the production of Wheat in 2010 and 2012?
- (iv) Complete the following table using this diagram.

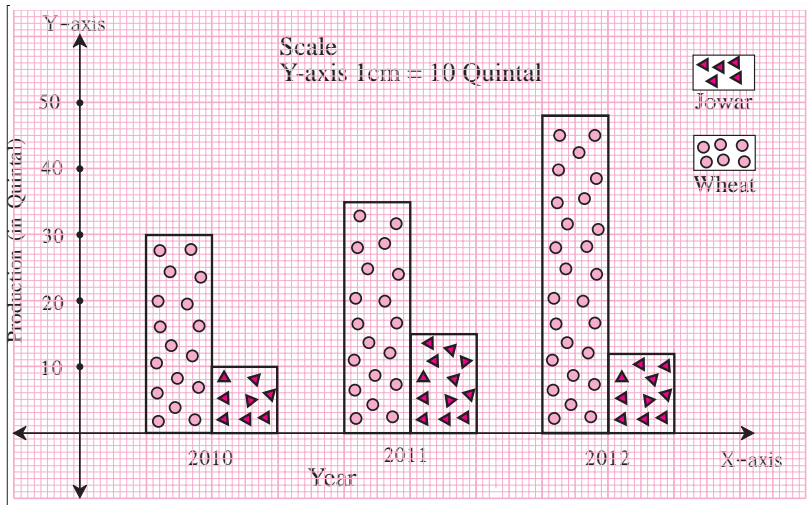

Production (in Quintal) Year	Wheat	Jowar	Total
2010			
2011			
2012	48	12	60



Let's learn.

Sub-divided bar diagram

To compare the information in the given data, we can also draw another type of bar-diagram.

To draw it, we add the numerical values of the entities, decide a scale and show the total by a bar proportional to the scale. Then we divide the bar in parts, proportional to the entities we had added. Hence this type of diagram is called a sub-divided bar diagram.

Now let us show the information in the previous example by a sub-divided bar diagram.

(i) Show the total production of the year 2010 by a bar. The height of the bar should be to the decided scale.

(ii) Show the production of wheat by lower part of the bar, the height of which is to the scale.

(iii) Obviously, remaining part of the bar denotes the production of Jowar for the year.

(iv) Similarly draw divided bars to show productions of the years 2011 and 2012.

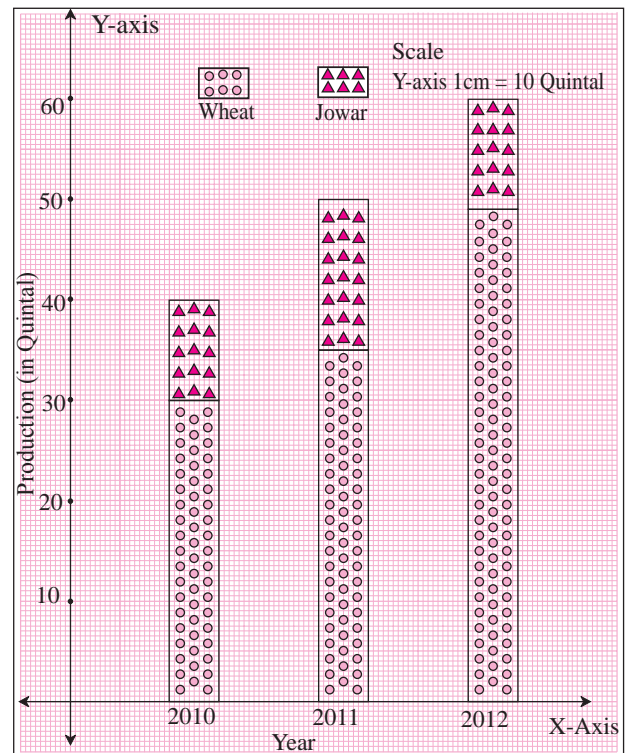

When two quantities are compared using percentages, it is more informative. We have studied this before. For example, if there is Rs.600 profit on Rs.2,000 and Rs.510 profit on Rs.1,500; Rs.600 looks greater amount. But if we calculate their percentages they are 30% and 34% respectively. Hence it is clear that Rs.510 profit on Rs.1,500 is a more profitable transaction.

Percentage bar diagram

To compare the given information, in a different way, it is converted into percentages and then a sub-divided bar diagram is drawn. Such diagram is known as 'Percentage bar-diagram'.

The information in the previous example is converted into percentages as shown in the adjacent table.

Year	Production of Wheat (Quintal)	Production of Jowar (Quintal)	Percentage production of Wheat as compared to total production
2010	30	10	$\frac{30}{40} \times 100 = 75\%$
2011	35	15	$\frac{35}{50} \times 100 = 70\%$
2012	48	12	$\frac{48}{60} \times 100 = 80\%$

The information is shown in the percentage bar diagram by following steps

(i) Yearly productions of Wheat and Jowar are converted into percentages.

(ii) The height of each bar to scale is taken as 100.

(iii) The percentage of production of Wheat is shown by the lower part of the bar to the scale.

(iv) The remaining upper part of the bar shows percentage production of Jowar.

Information of more than two entities can be shown by a sub divided bar diagram or by a percentage bar diagram.

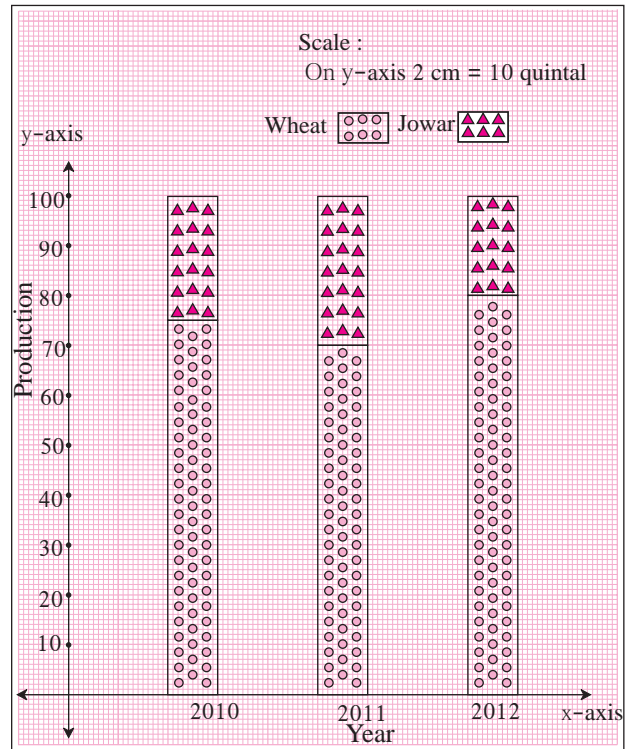

Solved examples :

Ex. 1. In the neighbouring figure, percentage bar-diagram is given. Percentage expenses on different items of two families are given. Answer the following questions based on it :

(i) Write the percentage expenses of every component for each family.

(ii) Which family spends more percent of expenses on food as compared to the other and by how much ?

(iii) What are the percentage expenses on other items ?

(iv) Which family shows more percentage expenses on electricity?

(v) Which family's percentage expense is more on education ?

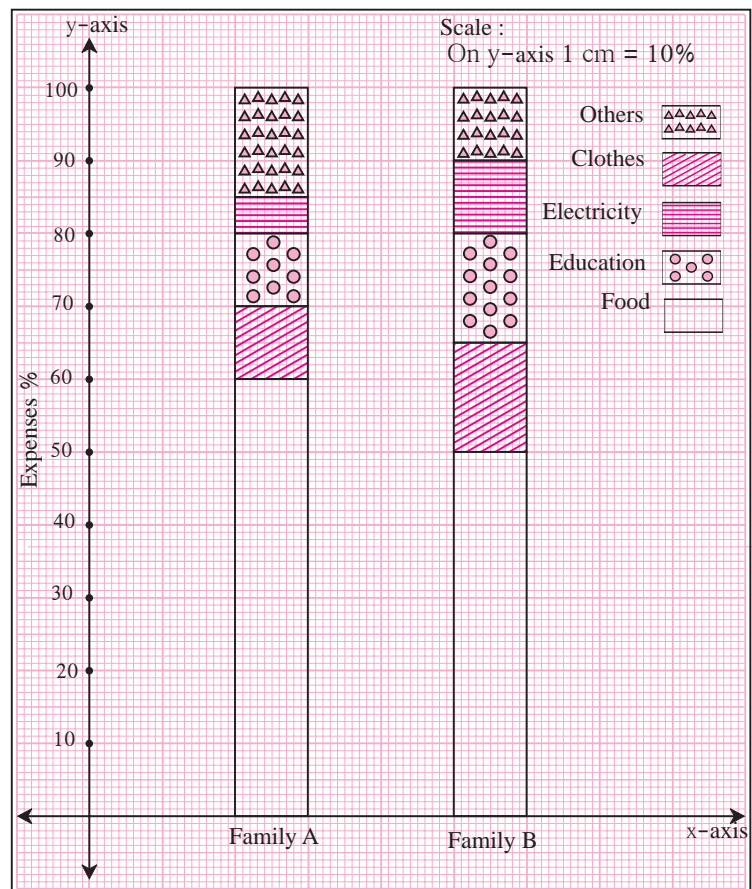

Solution :

(i)

Expenses Family	Food	Clothes	Education	Electricity	Others
A	60%	10%	10%	5%	15%
B	50%	15%	15%	10%	10%

(ii) Food expenses of family A are more by 10% as compared with family B.

(iii) Other expenses of family A are 15% and that of family B are 10%.

(iv) Percentage expenses on electricity of family B is greater.

(v) Percentage expenses on education are more of family B.

Practice set 7.1

(1) The following table shows the number of Buses and Trucks in nearest lakh units. Draw percentage bar-diagram. (Approximate the percentages to the nearest integer)

Year	No. of Trucks	No. of Buses
2006-2007	47	9
2007-2008	56	13
2008-2009	60	16
2009-2010	63	18

(2) In the table given below, the information is given about roads. Using this draw sub-divided and percentage bar-diagram (Approximate the percentages to the nearest integer)

Year	Permanent Roads (Lakh km.)	Temporary Roads (Lakh km.)
2000-2001	14	10
2001-2002	15	11
2002-2003	17	13
2003-2004	20	19

Activity : In the following table, the information of number of girls per 1000 boys is given in different States. Fill in the blanks and complete the table.

States	Boys	Girls	Total	Percentage of boys	Percentage of girls
Assam	1000	960	1960	$\frac{1000}{1960} \times \frac{100}{1} = 51\%$	$100 - 51 = 49\%$
Bihar	1000	840	1840		
Punjab	1000	900			
Kerala	1000	1080			
Maha-rashtra	1000	900			

Draw percentage bar-diagram from this information and discuss the findings from the diagram.



Use your brain power!

On page 111, for the given activity, the information of number of girls per 1000 boys is given for five states.

The literacy percentage of these five States is given below.

Assam (73%), Bihar (64%), Punjab (77%), Kerala (94%), Maharashtra (83%).

Think of the number of girls and the literacy percentages in the respective states. Can you draw any conclusions from it ?



Let's discuss.

To show following information diagrammatically, which type of bar-diagram is suitable?

- (1) Literacy percentage of four villages.
- (2) The expenses of a family on various items.
- (3) The numbers of girls and boys in each of five divisions.
- (4) The number of people visiting a science exhibition on each of three days.
- (5) The maximum and minimum temperature of your town during the months from January to June.
- (6) While driving a two-wheeler, number of people wearing helmets and not wearing helmet in 100 families.



Let's learn.

Statistics

Suppose, a large group (population) is to be studied with a particular aspect. (For example, blood pressures of senior citizens in a locality) For the purpose, a sufficiently small part of the group is selected randomly. This small group represents the large group (sample). The necessary information is gathered from the representative group which, in general, is numerical in most of the cases. The analysis of the information enables us to draw conclusions. The study of this type is called 'Statistics'.

The word Statistics is originated from the Latin word 'status', which means situation of a state. This suggests that in ancient times statistics was used for administrative purposes. Today, it is used in many fields of knowledge.

Sir Ronald Aylmer Fisher (17 February 1890 - 29 July 1962) is known as Father of Statistics.

Data collection

Teacher : Suppose, you want to know how much agricultural land is owned by every family in the village. What will you do?

Robert : We will visit each house in the village and record the information about agricultural land owned by them.

Teacher : Correct, my dear students, when we collect information of a group it is called as 'data'. Generally it is numerical. We must know the purpose of collecting it. If some one collects the information personally by asking questions, taking measurements, etc. it is called as the 'Primary Data'.

Afrin : So, the data collected regarding agricultural land, as Robert said, is primary data.

Teacher : Yes, well said Afrin !

Ramesh : But what to do if we want to collect the above data in a short time ?

Teacher : What Ramesh is saying is right. In this situation we have to use another method of data collection. Think what it could be ?

Ketaki : We can go to village Talathi office and can get the information from their records.

Teacher : Correct, in some situations, because of lack of time, lack of resources, we can't collect information personally. In such cases, we have to use the information, already collected in the form of records, information published in journals, case-studies etc. The data collected from such sources is known as 'Secondary data'. So as suggested by Ketaki, the data collected from village Talathi office, regarding agricultural land is secondary data.

See the following examples :

- (i) The chart made from information published in news paper is secondary data.
- (ii) The feedback of customers in a restaurant regarding quality of the food is primary data.
- (iii) The heights of students recorded by actual measurements is primary data.

Primary data	Secondary data
<ol style="list-style-type: none">1. It requires more time.2. It is up to date and detailed information.3. It is correct and reliable.	<ol style="list-style-type: none">1. It is readily available, so needs less time2. It is taken from already collected data. It is not necessarily up to date. It may lack in details also.3. It may be less reliable.

Activity : You gather information for several reasons. Take a few examples and discuss whether the data is primary or secondary.

Practice set 7.2

- (1) Classify following information as primary or secondary data.
- (i) Information of attendance of every student collected by visiting every class in a school.
 - (ii) The information of heights of students was gathered from school records and sent to the head office, as it was to be sent urgently.
 - (iii) In the village Nandpur, the information collected from every house regarding students not attending school.
 - (iv) For science project, information of trees gathered by visiting a forest.



Let's recall.

Classification of data

Ex.(1) The record of marks out of 20 in Mathematics in the first unit test is as follows.

20, 6, 14, 10, 13, 15, 12, 14, 17, 17, 18, 11, 19, 9, 16, 18, 14, 7, 17, 20,
8, 15, 16, 10, 15, 12, 18, 17, 12, 11, 11, 10, 16, 14, 16, 18, 10, 7, 17, 14,
20, 17, 13, 15, 18, 20, 12, 12, 15, 10

What is the above information called ?

-Primary data

What is each of the numbers in the data called ?

-A score

Answer the following questions, from the above information.

- (i) How many students scored 15 marks ?
- (ii) How many students scored more than 15 marks ?
- (iii) How many students scored less than 15 marks ?
- (iv) What is the lowest score of the group ?
- (v) What is the highest score the group ?



Let's discuss.

- (1) Was it easy to find out the answers of the above questions ? Did you refer the data frequently ?
- (2) What should we do to find answers easily ?

Shamim : We had to refer the data frequently. It was tedious and boring. If we write the data in ascending or descending order the above answers could be found easily.

According to Shamim's suggestion, let us arrange the data in ascending order.

6, 7, 7, 8, 9, 10, 10, 10, 10, 10, 11, 11, 11, 12, 12, 12, 12, 12, 13, 13,
14, 14, 14, 14, 14, 15, 15, 15, 15, 15, 16, 16, 16, 16, 17, 17, 17, 17, 17,
18, 18, 18, 18, 18, 19, 20, 20, 20, 20

Verify that the ascending order of scores helps to find the answers of the questions in Ex. (1) easily.



Let's recall.

Martin : Writing the data in a tabular form can also make the above work easy, We have studied this in previous year. This table is known as 'frequency distribution table'.

Teacher : Correct Martin ! Now let us prepare a table of the information given in example (1).

In example (1), the lowest score is 6 and the highest score is 20. Hence in the table, we write, numbers from 6 to 20 in the column of scores. In second column we record tally marks and in last column, frequency by counting the tally marks. (Complete the table.)

Frequency Distribution Table

Score	Tally Marks	Frequency (No.of students)
6		1
7		2
8		
9		
10		5
11		
12		
13		
14		
15		
16		
17		6
18		
19		
20		4
		Total N = 50

Make it sure that the sum of all frequencies, N is 50.



Let's discuss.

- (i) Is the above table is very long ?
- (ii) If the number of observations are more, is it difficult to make a table ?

Grouped frequency distribution table

Teacher : From above discussion, we conclude that, when number of observations is large, preparing a table is time consuming. What can be done to condense the data and save time ?

Rohit : In this situation, we can group the scores in the data.

Teacher : Well done Rohit! If we group the scores, that means if we make their classes, then the data will be condensed and time can be saved. Such a table is known as grouped frequency distribution table.

These are two methods of preparing a grouped frequency distribution table.

- (1) Inclusive method (2) Exclusive method

(1) Inclusive method (Discrete classes)

6, 7, 7, 8, 9, 10, 10, 10, 10, 10, 11, 11, 11, 12, 12, 12, 12, 12, 13, 13, 14, 14, 14, 14, 14, 15, 15, 15, 15, 15, 16, 16, 16, 16, 17, 17, 17, 17, 17, 17, 18, 18, 18, 18, 18, 19, 20, 20, 20, 20

In the above scores the smallest is \square and the largest is \square . The difference between largest and smallest scores is $20 - 6 = 14$. This difference is called as ‘Range of the data’.

By noticing the range, how can we classify the data into convenient classes ?

We can take classes like this.

- (i) 6 to 8, 9 to 11, 12 to 14, 15 to 17, 18 to 20 or
(ii) 6 to 10, 11 to 15, 16 to 20.

By taking classes 6 – 10, 11 – 15 & 16 – 20, let us prepare frequency distribution table.

Grouped Frequency Distribution Table (inclusive method)

Class	Tally marks	Frequency (No.of students)
6 – 10		10
11 – 15
16 – 20	20
		N = 50

While preparing this table, 6, 10 and all scores between them are included in the class 6–10 hence such classes are known as ‘Inclusive Classes’ of ‘discrete class system’ of the data.



Basic terms in statistics :

- (1) **Class :** When the observations are divided into suitable groups, each of the groups is called a ‘Class’.
- (2) **Class-Limit :** The end values of the classes are called class-limits.
For the class 6-10, the lower class limit is 6 and the upper class limit is 10.
- (3) **Frequency :** The total number of observations in to each class is called the ‘frequency’ of the that class.

In the above table, there are 20 observations in the class 11 to 15. Hence frequency of the class 11 – 15 is 20.

4. **Class width or Class Size or Class-interval :** When continuous classes are given, the difference between upper class limit and lower class limit is known as class-width.

For example, if 5 - 10, 10 - 15, 15-20, ...are given classes,
class width of 5-10 is $10 - 5 = 5$.

5. **Class mark :** The average of the lower class limit and the upper class limit for a given class is known as class mark

$$\text{Class mark} = \frac{\text{Lower class limit} + \text{Upper class limit}}{2}$$

For example, class mark the for class 11 to 15 = $\frac{\square + \square}{2} = \frac{26}{2} = 13$

(2) Exclusive method (Continuous classes)

Ex. 6, 10, 10.5, 11, 15.5, 19, 20, 12, 13 are the given observations. By taking classes 6-10, 11-15, 16-20 prepare grouped frequency distribution table.

Solution :

Classes	Tally marks	Frequency (f)
6-10		2
11-15		3
16-20		2

In the above table, we could not include observations 10.3 and 15.7.

Because the numbers 10.3 and 15.7 cannot be included in any of the classes 6-10, 11-15, 16-20. Hence in order to include them, we have to change the structure of the classes. Therefore if we take class intervals as 5-10 10-15, 15-20 the problem will be solved. The scores 10.3 and 15.7 can be included in the classes 10-15 and 15-20 respectively. But still a question arises. In which interval the score 10 should be included ? In 5-10 or 10-20 ? To overcome the difficulty, we follow a convention. We will include the score 10 in the class 10-15 instead of 5-10. That is the upper class limit of a class should be excluded from the class. Therefore, this is called the exclusive method of classification.

Now taking classes accordingly and as per the convention of exclusion, we can prepare the table as follows.

Grouped frequency distribution table (Exclusive method)

Class interval Marks	Tally marks	Frequency (No. of students)
5-10		1
10-15		5
15-20		2
20-25		1



Remember this !

Frequency Distribution Table

Ungrouped

Ages of 9th std. students	No. of Students
14	12
15	23
16	10

Grouped

Inclusive Method (Discrete classes)

Shoe size	No. of Students
2-4	12
5-7	29
8-10	7

Exclusive Method (Continuous classes)

Height (cm)	No. of students
145-150	18
150-155	27
155-160	3

Practice set 7.3

- (1) For class interval 20-25 write the lower class limit and the upper class limit.
- (2) Find the class-mark of the class 35-40.
- (3) If class mark is 10 and class width is 6 then find the class.
- (4) Complete the following table.

Classes (age)	Tally marks	Frequency (No. of students)
12-13		<input type="text"/>
13-14		<input type="text"/>
14-15		<input type="text"/>
15-16		<input type="text"/>
		$N = \sum f = 35$

- (5) In a 'tree plantation' project of a certain school there are 45 students of 'Harit Sena.' The record of trees planted by each student is given below :
3, 5, 7, 6, 4, 3, 5, 4, 3, 5, 4, 7, 5, 3, 6, 6, 5, 3, 4, 5, 7, 3, 5, 6, 4, 4, 3,
5, 6, 6, 4, 3, 5, 7, 3, 4, 5, 7, 6, 4, 3, 5, 4, 4, 7.
Prepare a frequency distribution table of the data.
- (6) The value of π upto 50 decimal places is given below :
3.14159265358979323846264338327950288419716939937510
From this information prepare an ungrouped frequency distribution table of digits appearing after the decimal point.

- (7) In the tables given below, class-mark and frequencies is given. Construct the frequency tables taking inclusive and exclusive classes.

(i)

Class width	Frequency
5	3
15	9
25	15
35	13

(ii)

Class width	Frequency
22	6
24	7
26	13
28	4

- (8) In a school, 46 students of 9th standard, were told to measure the lengths of the pencils in their compass-boxes in centimeters. The data collected was as follows.

16, 15, 7, 4.5, 8.5, 5.5, 5, 6.5, 6, 10, 12,
 13, 4.5, 4.9, 16, 11, 9.2, 7.3, 11.4, 12.7, 13.9, 16,
 5.5, 9.9, 8.4, 11.4, 13.1, 15, 4.8, 10, 7.5, 8.5, 6.5,
 7.2, 4.5, 5.7, 16, 5.7, 6.9, 8.9, 9.2, 10.2, 12.3, 13.7,
 14.5, 10

By taking inclusive classes 0-5, 5-10, 10-15.... prepare a grouped frequency distribution table.

- (9) In a village, the milk was collected from 50 milkmen at a collection center in litres as given below :

27, 75, 5, 99, 70, 12, 15, 20, 30, 35, 45, 80,
 77, 90, 92, 72, 4, 33, 22, 15, 20, 28, 29, 14,
 16, 20, 72, 81, 85, 10, 16, 9, 25, 23, 26, 46,
 55, 56, 66, 67, 51, 57, 44, 43, 6, 65, 42, 36,
 7, 35.

By taking suitable classes, prepare grouped frequency distribution table.

- (10) 38 people donated to an organisation working for differently abled persons. The amount in rupees were as follows :

101, 500, 401, 201, 301, 160, 210, 125, 175, 190, 450, 151,
 101, 351, 251, 451, 151, 260, 360, 410, 150, 125, 161, 195,
 351, 170, 225, 260, 290, 310, 360, 425, 420, 100, 105, 170,
 250, 100.

- (i) By taking classes 100-149, 150-199, 200-249... prepare grouped frequency distribution table.

- (ii) From the table, find the number of people who donated rupees 350 or more.



Let's learn.

Less than Cumulative frequency less than the upper class limit

Ex. : The following information is regarding marks in mathematics, obtain out of 40, scored by 50 students of 9th std. in the first unit test.

Class Interval	Frequency (no.of students)
0-10	02
10-20	12
20-30	20
30-40	16
	Total N = 50

(1) From the table, fill in the blanks in the following statements.

(i) For class interval 10-20 the lower class limit is and upper class limit is

(ii) How many students obtained marks less than 10 ?

(iii) How many students obtained marks less than 20 ? $2 + \text{$ = 14

(iv) How many students obtained marks less than 30 ? $\text{$ + $\text{$ = 34

(v) How many students obtained marks less than 40 ? $\text{$ + $\text{$ = 50



Remember this !

The sum of the frequency of a certain class and all the frequencies of previous classes is called as cumulative frequency less than the upper class limit for that given class. In short, it is also called as 'less than type' cumulative frequency.

The Meaning of less than type cumulative frequency :

Classes marks	Frequency	Less than type cumulative frequency
0-10	2	2
10-20	12	$2 + 12 = \text{$
20-30	20	$\text{$ + 20 = 34
30-40	16	$34 + \text{$ = 50
Total 50		

Class	Cumulative frequency	Meaning of less than type cumulative frequency
0-10	2	2 students got less than 10 marks
10-20	14	14 students got less than 20 marks
20-30	34	34 students got less than 30 marks
30-40	50	50 students got less than 40 marks
Total 50		

(2) Cumulative frequency more than or equal to the lower class limit

Classes	Frequency	Cumulative freq.	Classes	Cum. freq.	Meaning of cumulative frequency more than or equal to the lower class limit
0-10	2	50	0-10	50	50 students got 0 or more than 0 marks
10-20	12	$50 - 2 = 48$	10-20	48	48 students got 10 or more than 10 marks
20-30	20	$48 - 12 = 36$	20-30	36	36 students got 20 or more than 20 marks
30-40	16	$36 - 20 = 16$	30-40	16	16 students got 30 or more than 30 marks
Total 50					

Ex. A sports club has organised a table-tennis tournaments. The following table gives the distribution of players ages. Find the cumulative frequencies equal to or more than the lower class limit and complete the table.

Solution : Equal to lower limit or more than lower limit type of cumulative table.

Age (Year)	Tally marks	Frequency (No. of students)	Equal to lower limit or more than lower limit
10-12		09	50
12 - 14		<input type="text"/>	<input type="text"/> - 9 = 41
14-16		<input type="text"/>	41 - 23 = <input type="text"/>
16 - 18		05	<input type="text"/> - 13 = <input type="text"/>
		Total N = 50	

Practice set 7.4

(1) Complete the following cumulative frequency table :

Class (Height in cm)	Frequency (No. of students)	Less than type frequency
150-153	05	05
153-156	07	$05 + \square = \square$
156-159	15	$\square + 15 = \square$
159-162	10	$\square + \square = 37$
162-165	05	$37 + 5 = 42$
165-168	03	$\square + \square = 45$
	Total N = 45	

(2) Complete the following Cumulative Frequency Table :

Class (Monthly income in Rs.)	Frequency (No. of individuals)	More than or equal to type cumulative frequency
1000-5000	45
5000-10000	19
10000-15000	16
15000-20000	02
20000-25000	05
	Total N = 87	

(3) The data is given for 62 students in a certain class regarding their mathematics marks out of 100. Take the classes 0-10, 10-20.. and prepare frequency distribution table and cumulative frequency table more than or equal to type.

55, 60, 81, 90, 45, 65, 45, 52, 30, 85, 20, 10,
 75, 95, 09, 20, 25, 39, 45, 50, 78, 70, 46, 64,
 42, 58, 31, 82, 27, 11, 78, 97, 07, 22, 27, 36,
 35, 40, 75, 80, 47, 69, 48, 59, 32, 83, 23, 17,
 77, 45, 05, 23, 37, 38, 35, 25, 46, 57, 68, 45,
 47, 49.

From the prepared table, answer the following questions :

- (i) How many students obtained marks 40 or above 40 ?
 - (ii) How many students obtained marks 90 or above 90 ?
 - (iii) How many students obtained marks 60 or above 60 ?
 - (iv) What is the cumulative frequency of equal to or more than type of the class 0-10?
- (4) Using the data in example (3) above, prepare less than type cumulative frequency table and answer the following questions.
- (i) How many students obtained less than 40 marks ?
 - (ii) How many students obtained less than 10 marks ?
 - (iii) How many students obtained less than 60 marks ?
 - (iv) Find the cumulative frequency of the class 50-60.



Let's learn.

Measures of central tendency

Central Tendency : If the data collected in a survey of a group is sufficiently large, then it generally shows a peculiar property. The numbers in the data tend to cluster around a certain number. This property is called the **central tendency** of the group.

The number around which the numbers in the data tend to cluster is called **measure** of central tendency. It is supposed that the measure is a representative of the data.

In statistics, the measures of central tendency mainly used are as follows.

The following measures of central tendency are used :

- (1) **Mean** : The arithmetical average of all observations in the given data is known as its 'Arithmetic mean' or simply 'mean'.

$$\text{Mean} = \frac{\text{The sum of all observations in the data}}{\text{Total number of observation}}$$

Ex. (1) Find the mean of numbers 25, 30, 27, 23 and 25.

Solution :
$$\frac{25 + 30 + 27 + 23 + 25}{5} = \frac{130}{5} = 26$$

Ex. (2) The first unit test of 40 marks was conducted for a class of 35 students. The marks obtained by the students were as follows. Find the mean of the marks.

40, 35, 30, 25, 23, 20, 14, 15, 16, 20, 17, 37,
37, 20, 36, 16, 30, 25, 25, 36, 37, 39, 39, 40,
15, 16, 17, 30, 16, 39, 40, 35, 37, 23, 16.

Solution : Here, we can add all observations, but it will be a tedious job. Here 3 students obtained 30 marks each. So their sum is $30 + 30 + 30 = 90$, which is 30×3 . In this way the sum of marks of all students is worked out in the following table.

In statistics, it is convenient to use the Greek letter Σ (sigma) to show the sum of numbers.

In the adjacent table, 956 is the sum of the products $14 \times 1 + 15 \times 6 + \dots + 40 \times 3$. These are the products of the frequencies and the scores; in short of f 's and x 's.

The product of first frequency and first score is 14×1 , which we write as $f_1 \times x_1$.

The product of second frequency and second score is 15×2 , which we write as $f_2 \times x_2$.

In general, the product of i^{th} frequency and i^{th} score is written as $f_i \times x_i$.

So, using the letter Σ , the sum of the products $f_1 \times x_1 + f_2 \times x_2 + \dots + f_i \times x_i$ is in short written as $\Sigma f_i \times x_i$

Marks (x_i)	No. of students (f_i)	$f_i \times x_i$
14	1	$14 \times 1 = 14$
15	2	$15 \times 2 = \dots$
16	5	$16 \times \dots = \dots$
17	2	$17 \times 2 = 34$
20	3	$\dots \times 3 = \dots$
23	2	$23 \times 2 = \dots$
25	3	$25 \times 3 = \dots$
30	3	$\dots \times \dots = \dots$
35	2	$35 \times 2 = 70$
36	2	$\dots \times \dots = \dots$
37	4	$\dots \times \dots = \dots$
39	3	$39 \times 3 = 117$
40	3	$\dots \times \dots = 120$
	N= <input type="text"/>	$\Sigma f_i x_i = 956$

$$\begin{aligned} \bar{x} &= \frac{\Sigma f_i x_i}{N} = \frac{956}{35} \\ &= 27.31 \text{ marks (approximately)} \\ \therefore \text{ mean of the given data is } 27.31. \end{aligned}$$

(2) **Median** : The scores are arranged in ascending or descending order. The number appearing exactly at the middle position in this order is known as ‘Median’ of the observations.

If the number of observations is even then the median is the average of the middle two numbers.

Ex. (1) Find the median of 54, 63, 66, 72, 98, 87, 92.

Solution : Let us write the given observations in the ascending order.

54, 63, 66, 72, 78, 87, 92

Here the 4th number is at the middle position, which is 72

∴ Median of the scores = 72

Ex. (2) Find the median of the data. 30, 25, 32, 23, 42, 36, 40, 33, 21, 43

Solution : Let us write the given observations in the ascending order.

21, 23, 25, 30, 32, 33, 36, 40, 42, 43

Here number of observations = 10 which is an even number.

∴ the 5th and 6th numbers are in the middle position.

Those numbers are 32 and 33

$$\therefore \text{median} = \frac{32+33}{2} = \frac{65}{2} = 32.5$$



Let's recall.

If the number of observations is ‘ n ’ and

(i) if ‘ n ’ is odd, which observation is the median of the data ?

(ii) if ‘ n ’ is even, the average of which two numbers is the median ?

(3) **Mode** : The score which is repeated maximum number of times in the given data is known as the ‘mode’ of the data.

Ex. (1) Find the mode of 90, 55, 67, 55, 75, 75, 40, 35, 55, 95

Solution : If the data is arranged in ascending order, it is easy to find the observation repeating maximum number of times.

Ascending order of given data. 35, 40, 55, 55, 55, 67, 75, 75, 90, 95

The observation repeated maximum number of times = 55.

∴ mode for the given data is 55.

Ex (2) The ages of workers in a certain factory are given in the following table.

Age (Year)	19	21	25	27	30
Workers	5	15	13	15	7

Find the mode of their ages.

Solution : Here the maximum frequency is 15; but this is the frequency is of two observations.

∴ Mode = 21 and 27

∴ mode for ages is 21 years and 27 years.

Practice set 7.5

- (1) Yield of soyabean per acre in quintal in Mukund's field for 7 years was 10, 7, 5, 3, 9, 6, 9. Find the mean of yield per acre.
- (2) Find the median of the observations, 59, 75, 68, 70, 74, 75, 80.
- (3) The marks (out of 100) obtained by 7 students in Mathematics' examination are given below. Find the mode for these marks.
99, 100, 95, 100, 100, 60, 90
- (4) The monthly salaries in rupees of 30 workers in a factory are given below.
5000, 7000, 3000, 4000, 4000, 3000, 3000, 3000, 8000, 4000,
4000, 9000, 3000, 5000, 5000, 4000, 4000, 3000, 5000, 5000,
6000, 8000, 3000, 3000, 6000, 7000, 7000, 6000, 6000, 4000
From the above data find the mean of monthly salary.
- (5) In a basket there are 10 tomatoes. The weight of each of these tomatoes in grams is as follows 60, 70, 90, 95, 50, 65, 70, 80, 85, 95.
Find the median of the weights of tomatoes.
- (6) A hockey player has scored following number of goals in 9 matches.
5, 4, 0, 2, 2, 4, 4, 3, 3. Find the mean, median and mode of the data.
- (7) The calculated mean of 50 observations was 80. It was later discovered that observation 19 was recorded by mistake as 91. What was the correct mean?
- (8) Following 10 observations are arranged in ascending order as follows.
2, 3, 5, 9, $x + 1$, $x + 3$, 14, 16, 19, 20
If the median of the data is 11, find the value of x .
- (9) The mean of 35 observations is 20, out of which mean of first 18 observations is 15 and mean of last 18 observation is 25. Find the 18th observation.
- (10) The mean of 5 observations is 50. One of the observations was removed from the data, hence the mean became 45. Find the observation which was removed.
- (11) There are 40 students in a class, out of them 15 are boys. The mean of marks obtained by boys is 33 and that for girls is 35. Find out the mean of all students in the class.
- (12) The weights of 10 students (in kg) are given below :
40, 35, 42, 43, 37, 35, 37, 37, 42, 37. Find the mode of the data.
- (13) In the following table, the information is given about the number of families and the siblings in the families less than 14 years of age. Find the mode of the data.

No. of siblings	1	2	3	4
Families	15	25	5	5

- (14) Find the mode of the following data.

Marks	35	36	37	38	39	40
No. of students	09	07	09	04	04	02

Which is a suitable measure of Central Tendency ? The answer of this question is related to the purpose of the survey.

For example, the number of runs scored by a player in continuous 11 matches are 41, 58, 35, 80, 23, 12, 63, 48, 107, 9, 73 respectively. To find his overall performance we have to consider the runs he scored in each match. Hence, the suitable measure in this example is mean.

If a company has to decide, the number of shirts to be manufactured 'different sizes'. For this out of 34, 36, 38, 40, 42, 44, which size shirts are used by maximum customers are to be found. By observation it can be found. Here the mode is useful to decide, how many shirts to be manufactured of each size.

Problem set 7

- (1) Write the correct alternative answer for each of the following questions.
- (i) Which of the following data is not primary ?
 - (A) By visiting a certain class, gathering information about attendance of students.
 - (B) By actual visit to homes, to find number of family members.
 - (C) To get information regarding plantation of soyabean done by each farmer from the village Talathi.
 - (D) Review the cleanliness status of canals by actually visiting them.
 - (ii) What is the upper class limit for the class 25-35 ?
 - (A) 25 (B) 35 (C) 60 (D) 30
 - (iii) What is the class-mark of class 25-35 ?
 - (A) 25 (B) 35 (C) 60 (D) 30
 - (iv) If the classes are 0-10, 10-20, 20-30... then in which class should the observation 10 be included ?
 - (A) 0-10 (B) 10-20 (C) 0-10 and 10-20 in these 2 classes (D) 20-30
 - (v) If \bar{x} is the mean of x_1, x_2, \dots, x_n and \bar{y} is the mean of y_1, y_2, \dots, y_n and \bar{z} is the mean of $x_1, x_2, \dots, x_n, y_1, y_2, \dots, y_n$ then $\bar{z} = ?$
 - (A) $\frac{\bar{x} + \bar{y}}{2}$ (B) $\bar{x} + \bar{y}$ (C) $\frac{\bar{x} + \bar{y}}{n}$ (D) $\frac{\bar{x} + \bar{y}}{2n}$
 - (vi) The mean of five numbers is 80, out of which mean of 4 numbers is 46, find the 5th number :
 - (A) 4 (B) 20 (C) 434 (D) 66
 - (vii) Mean of 100 observations is 40. The 9th observation is 30. If this is replaced by 70 keeping all other observations same, find the new mean.
 - (A) 40.6 (B) 40.4 (C) 40.3 (D) 40.7
 - (viii) What is the the mode of 19, 19, 15, 20, 25, 15, 20, 15?
 - (A) 15 (B) 20 (C) 19 (D) 25

(ix) What is the median of 7, 10, 7, 5, 9, 10 ?

- (A) 7 (B) 9 (C) 8 (D) 10

(x) From following table, what is the cumulative frequency of less than type for the class 30-40 ?

Class	0-10	10-20	20-30	30-40	40-50
Frequency	7	3	12	13	2

- (A) 13 (B) 15 (C) 35 (D) 22

(2) The mean salary of 20 workers is Rs.10,250. If the salary of office superintendent is added, the mean will increase by Rs.750. Find the salary of the office superintendent.

(3) The mean of nine numbers is 77. If one more number is added to it then the mean increases by 5. Find the number added in the data.

(4) The monthly maximum temperature of a city is given in degree celcius in the following data. By taking suitable classes, prepare the grouped frequency distribution table.

29.2, 29.0, 28.1, 28.5, 32.9, 29.2, 34.2, 36.8, 32.0, 31.0,
30.5, 30.0, 33, 32.5, 35.5, 34.0, 32.9, 31.5, 30.3, 31.4,
30.3, 34.7, 35.0, 32.5, 33.5, 29.0, 29.5, 29.9, 33.2, 30.2

From the table, answer the following questions.

(i) For how many days the maximum temperature was less than 34°C ?

(ii) For how many days the maximum temperature was 34°C or more than 34°C ?

(5) If the mean of the following data is 20.2, then find the value of p .

x_i	10	15	20	25	30
f_i	6	8	p	10	6

(6) There are 68 students of 9th standard from model Highschool, Nandpur. They have scored following marks out of 80, in written exam of mathematics.

70, 50, 60, 66, 45, 46, 38, 30, 40, 47, 56, 68,
80, 79, 39, 43, 57, 61, 51, 32, 42, 43, 75, 43,
36, 37, 61, 71, 32, 40, 45, 32, 36, 42, 43, 55,
56, 62, 66, 72, 73, 78, 36, 46, 47, 52, 68, 78,
80, 49, 59, 69, 65, 35, 46, 56, 57, 60, 36, 37,
45, 42, 70, 37, 45, 66, 56, 47

By taking classes 30-40, 40-50, prepare the less than type cumulative frequency table
Using the table, answer the following questions :

(i) How many students, have scored marks less than 80 ?

(ii) How many students have scored marks less than 40 ?

(iii) How many students have scored marks less than 60 ?

- (7) By using data in example (6), and taking classes 30-40, 40-50... prepare equal to or more than type cumulative frequency table and answer the following questions based on it.
- How many students have scored marks 70 or more than 70 ?
 - How many students have scored marks 30 or more than 30 ?
- (8) There are 10 observations arranged in ascending order as given below.
45,47,50,52, x , $x+2$, 60,62,63,74. The median of these observations is 53.
Find the value of x . Also find the mean and the mode of the data.



Fun with
maths



Pascal's Triangle (Meru prastar)

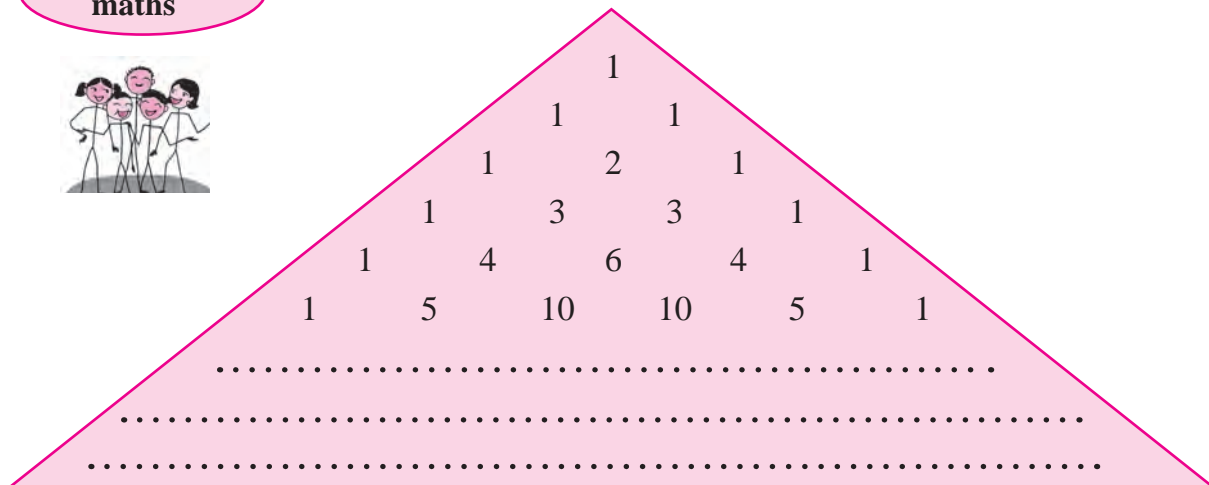

This arrangement is known as Pascal's triangle. Write the remaining 3 lines of above arrangement. The numbers obtained in above arrangement in horizontal lines denote the coefficients of the expansion of $(x + y)^n$. See the following expansions :

$$(x + y)^0 = 1$$

$$(x + y)^1 = 1x + 1y$$

$$(x + y)^2 = 1x^2 + 2xy + 1y^2$$

$$(x + y)^3 = 1x^3 + 3x^2y + 3xy^2 + y^3$$

$$(x + y)^4 = 1x^4 + 4x^3y + 6x^2y^2 + 4xy^3 + 1y^4$$

Observe the degrees of x and y in the above expansions.

Try to write the expansion of $(x + y)^{10}$ from above arrangement.

Answers

1. Sets

Practice set 1.1

- (1) (i) $\{2, 4, 6, 8, \dots\}$ (ii) $\{2\}$ (iii) $\{-1, -2, -3, \dots\}$ (iv) $\{\text{sa, re, ga, ma, pa, dha, ni}\}$
- (2) (i) $\frac{4}{3}$ is an element of set Q. (ii) -2 is not an element of set N
- (iii) Set P is a set of all p 's such that p is an odd number.
- (4) (i) $A = \{\text{Chaitra, Vaishakh, Jyeshth, Ashadh, Shravan, Bhadra, Ashwin, Kartik, Agrahayan, Paush, Magh, Phalgun}\}$
- (ii) $X = \{\text{C, O, M, P, L, E, N, T}\}$ (iii) $Y = \{\text{Nose, Ears, Eyes, Tounge, Skin}\}$
- (iv) $Z = \{2, 3, 5, 7, 11, 13, 17, 19\}$
- (v) $E = \{\text{Asia, Africa, Europe, Australia, Antarctica, South America, North America}\}$
- (5) (i) $A = \{x \mid x = n^2, n \in \mathbb{N}, n \leq 10\}$ (ii) $B = \{x \mid x = 6n, n \in \mathbb{N}, n < 9\}$
- (iii) $C = \{y \mid y \text{ is a letter in the word 'SMILE'}\}$
- (iv) $D = \{z \mid z \text{ is a day of a week}\}$ (v) $X = \{y \mid y \text{ is a letter in the word 'eat'}\}$

Practice set 1.2

- (1) $A = B = C$ (2) $A = B$ (3) A and C are empty sets.
- (4) (i), (iii), (iv), (v) are finite sets (ii), (vi), (vii) are infinite sets

Practice set 1.3

- (1) (i), (ii), (iii), (v) are false and (iv), (vi) are true statements.
- (4) $\{1\}, \{3\}, \{2\}, \{7\}, \{1, 3\}, \{1, 2\}, \{1, 7\}, \{3, 2\}, \{3, 7\}, \{2, 7\}, \{1, 3, 2\}, \{1, 2, 7\}, \{3, 2, 7\}, \{1, 3, 2, 7\}$ any three like these sets..
- (5) (i) $P \subseteq H, P \subseteq B, I \subseteq M, I \subseteq B, H \subseteq B, M \subseteq B$ (ii) set B
- (6) (i) N, W, I any of these sets. (ii) N, W, I any of these sets.
- (7) Set of students getting marks less than 50% in Maths.

Practice set 1.4

- (1) $n(B) = 21$ (2) Number of students who do not take any of the drinks = 5
- (3) Total number of students = 70
- (4) The number of students who do not like rock climbing and sky-watching = 20
The students who like only rock climbing = 20,
The students who like only sky watching = 70
- (5) (i) $A = \{x, y, z, m, n\}$ (ii) $B = \{p, q, r, m, n\}$
- (iii) $A \cup B = \{x, y, z, m, n, p, q, r\}$ (iv) $U = \{x, y, z, m, n, p, q, r, s, t\}$
- (v) $A' = \{p, q, r, s, t\}$ (vi) $B' = \{x, y, z, s, t\}$ (vii) $(A \cup B)' = \{s, t\}$

Problem set 1

- (1) (i) (C) (ii) (D) (iii) (C) (iv) (B) (v) (A) (vi) (A)
 (2) (i) (A) (ii) (A) (iii) (B) (iv) (C)
 (3) People speaking only English 57, People speaking only french 28,
 People speaking both languages 15
 (4) 135 (5) 12 (6) 4

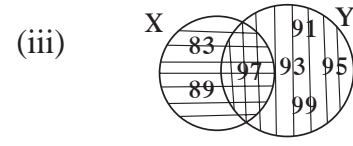
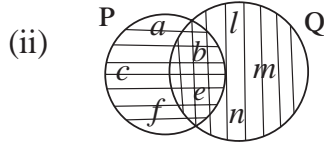
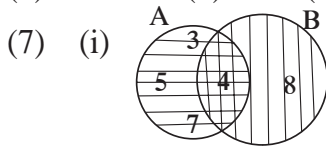

- (8) $S \subseteq X, V \subseteq X, S \subseteq X, T \subseteq X, S \subseteq Y, S \subseteq V, S \subseteq T, V \subseteq T, Y \subseteq T,$
 (9) $M \cup \phi = M, M \cap \phi = \phi$
 (10) $U = \{1, 2, 3, 4, 5, 7, 8, 9, 10, 11, 13\}, A = \{1, 2, 3, 5, 7\} B = \{1, 5, 8, 9, 10\}$
 $M \cup B = \{1, 2, 3, 5, 7, 8, 9, 10\}, A \cap B = \{1, 5\}$
 (11) $n(A \cup B) = 16$

2. Real Numbers

Practice set 2.1

- (1) Terminating (i), (iii), (iv) Non recurring non terminating (ii), (v)
 (2) (i) 0.635 (ii) $0.\overline{25}$ (iii) $3.\overline{285714}$ (iv) 0.8 (v) 2.125
 (3) (i) $\frac{2}{3}$ (ii) $\frac{37}{99}$ (iii) $\frac{314}{99}$ (iv) $\frac{1574}{99}$ (v) $\frac{2512}{999}$

Practice set 2.2

- (4) (i) Infinitely many numbers like $-0.4, -0.3, 0.2$
 (ii) Infinitely many numbers like $-2.310, -2.320, -2.325$
 (iii) Infinitely many numbers like $5.21, 5.22, 5.23$
 (iv) Infinitely many numbers like $-4.51, -4.55, -4.58$

Practice set 2.3

- (1) (i) 3 (ii) 2 (iii) 4 (iv) 2 (v) 3
 (2) (i), (iii), (vi) are surds and (ii), (iv), (v) are not surds.
 (3) Like surds : (i), (iii), (iv) and unlike surds : (ii), (v), (vi)
 (4) (i) $3\sqrt{3}$ (ii) $5\sqrt{2}$ (iii) $5\sqrt{10}$ (iv) $4\sqrt{7}$ (v) $2\sqrt{42}$
 (5) (i) $7\sqrt{2} > 5\sqrt{3}$ (ii) $\sqrt{247} < \sqrt{274}$ (iii) $2\sqrt{7} = \sqrt{28}$
 (iv) $5\sqrt{5} < 7\sqrt{5}$ (v) $4\sqrt{42} > 9\sqrt{2}$ (vi) $5\sqrt{3} < 9$ (vii) $7 > 2\sqrt{5}$
 (6) (i) $13\sqrt{5}$ (ii) $10\sqrt{5}$ (iii) $24\sqrt{3}$ (iv) $\frac{12}{5}\sqrt{7}$

- (7) (i) $18\sqrt{6}$ (ii) $126\sqrt{5}$ (iii) $6\sqrt{10}$ (iv) 80
 (8) (i) 7 (ii) $\sqrt{\frac{5}{2}}$ (iii) $\sqrt{2}$ (iv) $\sqrt{62}$.
 (9) (i) $\frac{3}{5}\sqrt{5}$ (ii) $\frac{\sqrt{14}}{14}$ (iii) $\frac{5\sqrt{7}}{7}$ (iv) $\frac{2}{9}\sqrt{3}$ (v) $\frac{11}{3}\sqrt{3}$

Practice set 2.4

- (1) (i) $-3 + \sqrt{21}$ (ii) $\sqrt{10} - \sqrt{14}$ (iii) $-18 + 13\sqrt{6}$
 (2) (i) $\frac{\sqrt{7} - \sqrt{2}}{5}$ (ii) $\frac{3(2\sqrt{5} + 3\sqrt{2})}{2}$ (iii) $28 - 16\sqrt{3}$ (iv) $4 - \sqrt{15}$

Practice set 2.5

- (1) (i) 13 (ii) 5 (iii) 28 (2) 2 or $\frac{4}{3}$ (ii) 1 or 6 (iii) -2 or 18 (iv) 0 or -40

Problem set 2

- (1) (i) B (ii) D (iii) C (iv) D (v) A
 (vi) C (vii) C (viii) C (ix) A (x) B
 (2) (i) $\frac{555}{1000}$ (ii) $\frac{29539}{999}$ (iii) $\frac{9306}{999}$ (iv) $\frac{357060}{999}$ (v) $\frac{30189}{999}$
 (3) (i) $-0.\overline{714285}$ (ii) $0.\overline{81}$ (iii) 2.2360679... (iv) $9.\overline{307692}$ (v) 3.625
 (5) (i) $\frac{3}{2}\sqrt{2}$ (ii) $-\frac{5}{3}\sqrt{5}$
 (6) (i) $\sqrt{2}$ (ii) $\sqrt{2}$ (iii) $\sqrt{3}$ (iv) $\sqrt{10}$ (v) $\sqrt{2}$ (vi) $\sqrt{11}$
 (7) (i) $6\sqrt{3}$ (ii) $\frac{34}{3}\sqrt{3}$ (iii) $\frac{15}{2}\sqrt{6}$ (iv) $-25\sqrt{3}$ (v) $\frac{8}{3}\sqrt{3}$
 (8) (i) $\frac{\sqrt{5}}{5}$ (ii) $\frac{2\sqrt{7}}{21}$ (iii) $\sqrt{3} + \sqrt{2}$ (iv) $\frac{3\sqrt{5} - 2\sqrt{2}}{37}$ (v) $\frac{6(4\sqrt{3} + \sqrt{2})}{23}$

3. Polynomials

Practice set 3.1

- (1) (i) No, because index of y in $\frac{1}{y}$ is (-1) .
 (ii) No, because index of x in the term $5\sqrt{x}$ is $(\frac{1}{2})$.
 (iii) Yes. (iv) No, because index of m in the term $2m^{-2}$ is (-2) . (v) Yes.
 (2) (i) 1 (ii) $-\sqrt{3}$, (iii) $-\frac{2}{3}$
 (3) (i) x^7 (ii) $2x^{35} - 7$ (iii) $x^8 - 2x^5 + 3$ other polynomials like these.
 (4) (i) 0 (ii) 0 (iii) 2 (iv) 10 (v) 1 (vi) 5 (vii) 3 (viii) 10
 (5) (i) Quadratic (ii) Linear (iii) Linear (iv) Cubic (v) Quadratic (vi) Cubic

- (6) (i) $m^3 + 5m + 3$ (ii) $y^5 + 2y^4 + 3y^3 - y^2 - 7y - \frac{1}{2}$
 (7) (i) $(1, 0, 0, -2)$ (ii) $(5, 0)$ (iii) $(2, 0, -3, 0, 7)$ (iv) $\left(\frac{-2}{3}\right)$
 (8) (i) $x^2 + 2x + 3$ (ii) $5x^4 - 1$ (iii) $-2x^3 + 2x^2 - 2x + 2$
 (9) Quadratic polynomial : x^2 ; $2x^2 + 5x + 10$; $3x^2 + 5x$;
 Cubic polynomial : $x^3 + x^2 + x + 5$; $x^3 + 9$ Linear polynomial : $x + 7$;
 Binomial : $x + 7$, $x^3 + 9$; Trinomial : $2x^2 + 5x + 10$; Monomial : x^2

Practice set 3.2

- (1) (i) $a + bx$ (ii) xy (iii) $10n + m$
 (2) (i) $6x^3 - 2x^2 + 2x$ (ii) $-2m^4 + 2m^3 + 2m^2 + 3m - 6 + \sqrt{2}$ (iii) $5y^2 + 6y + 11$
 (3) (i) $-6x^2 + 10x$ (ii) $10ab^2 + a^2b - 7ab$
 (4) (i) $2x^3 - 4x^2 - 2x$ (ii) $x^8 + 2x^7 + 2x^5 - x^3 - 2x^2 - 2$ (iii) $-4y^4 + 7y^2 + 3y$
 (5) (i) $x^3 - 64 = (x - 4)(x^2 + 4x + 16) + 0$
 (ii) $5x^5 + 4x^4 - 3x^3 + 2x^2 + 2 = (x^2 - x)(5x^3 + 9x^2 + 6x + 8) + (8x + 2)$
 (6) $a^4 + 7a^2b^2 + 2b^4$

Practice set 3.3

- (1) (i) Quotient = $2m + 7$, Remainder = 45
 (ii) Quotient = $x^3 + 3x - 2$, Remainder = 9
 (iii) Quotient = $y^2 + 6y + 36$, Remainder = 0
 (iv) Quotient = $2x^3 - 3x^2 + 7x - 17$, Remainder = 51
 (v) Quotient = $x^3 - 4x^2 + 13x - 52$, Remainder = 200
 (vi) Quotient = $y^2 - 2y + 3$, Remainder = 2

Practice set 3.4

- (1) 5 (2) 1 (3) $4a^2 + 20$ (4) -11

Practice set 3.5

- (1) (i) -41 (ii) 7 (iii) 7 (2) (i) 1, 0, -8 (ii) 4, 5, 13 (iii) -2, 0, 10
 (3) 0 (4) 2 (5) (i) 17 (ii) $2a^3 - a^2 - a$ (iii) 1544 (6) 92 (7) Yes
 (8) 2 (9) (i) No (ii) Yes (10) 30 (11) Yes
 (13) (i) -3 (ii) 80

Practice set 3.6

- (1) (i) $(x + 1)(2x - 1)$ (ii) $(m + 3)(2m - 1)$ (iii) $(3x + 7)(4x + 11)$
 (iv) $(y - 1)(3y + 1)$ (v) $(x + \sqrt{3})(\sqrt{3}x + 1)$ (vi) $(x - 4)\left(\frac{1}{2}x - 1\right)$
 (2) (i) $(x - 3)(x + 2)(x - 2)(x + 1)$ (ii) $(x - 13)(x - 2)$

- (iii) $(x - 8)(x + 2)(x - 4)(x - 2)$ (iv) $(x^2 - 2x + 10)(x^2 - 2x - 2)$
 (v) $(y^2 + 5y - 22)(y + 4)(y + 1)$ (vi) $(y + 6)(y - 1)(y + 4)(y + 1)$
 (vii) $(x^2 - 8x + 18)(x^2 - 8x + 13)$

Problem set 3

- (1) (i) D (ii) D (iii) C (iv) A (v) C (vi) A (vii) D (viii) C (ix) A (x) A
 (2) (i) 4 (ii) 0 (iii) 9
 (3) (i) $7x^4 - x^3 + 4x^2 - x + 9$ (ii) $5p^4 + 2p^3 + 10p^2 + p - 8$
 (4) (i) (1, 0, 0, 0, 16) (ii) (1, 0, 0, 2, 3, 15)
 (5) (i) $3x^4 - 2x^3 + 0x^2 + 7x + 18$ (ii) $6x^3 + x^2 + 0x + 7$ (iii) $4x^3 + 5x^2 - 3x + 0$
 (6) (i) $10x^4 + 13x^3 + 9x^2 - 7x + 12$ (ii) $p^3q + 4p^2q + 4pq + 7$
 (7) (i) $2x^2 - 7y + 16$ (ii) $x^2 + 5x + 2$
 (8) (i) $m^7 - 4m^5 + 6m^4 + 6m^3 - 12m^2 + 5m + 6$
 (ii) $5m^5 - 5m^4 + 15m^3 - 2m^2 + 2m - 6$
 (9) Remainder = 19 (10) $m = 1$ (11) Total population = $10x^2 + 5y^2 - xy$
 (12) $b = \frac{1}{2}$ (13) $11m^2 - 8m + 5$ (14) $-2x^2 + 8x + 11$ (15) $2m + n + 7$

4. Ratio and Proportion

Practice set 4.1

- (1) (i) 6 : 5 (ii) 2 : 3 (iii) 2 : 3
 (2) (i) 25 : 11 (ii) 35 : 31 (iii) 2 : 1 (iv) 10 : 17 (v) 2 : 1 (vi) 220 : 153
 (3) (i) 3 : 4 (ii) 11 : 25 (iii) 1 : 16 (iv) 13 : 25 (v) 4 : 625
 (4) 4 people (5) (i) 60% (ii) 94% (iii) 70% (iv) 91% (v) 43.75%
 (6) Abha's age 18 years, Mother's age 45 years (7) After 6 years
 (8) Present age of Rehana is 8 years.

Practice set 4.2

- (1) (i) 20, 49, 2.5 respectively (ii) 7, 27, 2.25 respectively
 (2) (i) 1 : 2π (ii) 2 : r (iii) $\sqrt{2} : 1$ (iv) 34 : 35
 (3) (i) $\frac{\sqrt{5}}{3} < \frac{3}{\sqrt{7}}$ (ii) $\frac{3\sqrt{5}}{5\sqrt{7}} = \frac{\sqrt{63}}{\sqrt{125}}$ (iii) $\frac{5}{18} > \frac{17}{121}$
 (iv) $\frac{\sqrt{80}}{\sqrt{48}} = \frac{\sqrt{45}}{\sqrt{27}}$ (v) $\frac{9.2}{5.1} > \frac{3.4}{7.1}$

- (4) (i) 80° (ii) Present age of Albert is 25 years, Present age of Salim is 45 years
 (iii) Length 13.5 cm, Breadth 4.5 cm (iv) 124, 92 (v) 20, 18
- (5) (i) 729 (ii) $45 : 7$ (6) $2 : 125$ (7) $x = 5$

Practice set 4.3

- (1) (i) $22 : 13$ (ii) $125 : 71$ (iii) $316 : 27$ (iv) $38 : 11$
- (2) (i) $3 : 5$ (ii) $1 : 6$ (iii) $7 : 43$ (iv) $71 : 179$ (3) $170 : 173$
- (4) (i) $x = 8$ (ii) $x = 9$ (iii) $x = 2$ (iv) $x = 6$ (v) $x = \frac{9}{14}$ (vi) $x = 3$

Practice set 4.4

- (1) (i) 36, 22 (ii) $16, 2a - 2b + 2c$
- (2) (i) $29 : 21$ (ii) $23 : 7$ (4) (i) $x = 2$ (ii) $y = 1$

Practice set 4.5

- (1) $x = 4$ (2) $x = \frac{347}{14}$ (3) 18, 12, 8 or 8, 12, 18 (6) $\frac{x + y}{xy}$

Problem set 4

- (1) (i) B (ii) C (iii) B (iv) D (v) C
- (2) (i) $7 : 16$ (ii) $2 : 5$ (iii) $5 : 9$ (iv) $6 : 7$ (v) $6 : 7$
- (3) (i) $1 : 2$ (ii) $5 : 4$ (iii) $1 : 1$
- (4) (i) and (iii) are in continued proportion. (ii) and (iv) are not in continued proportion.
- (5) $b = 9$
- (6) (i) 7.4% (ii) 62.5% (iii) 73.33% (iv) 31.25% (v) 12%
- (7) (i) $5 : 6$ (ii) $85 : 128$ (iii) $1 : 2$ (iv) $50 : 1$ (v) $3 : 5$
- (8) (i) $\frac{17}{9}$ (ii) 19 (iii) $\frac{35}{27}$ (iv) $\frac{13}{29}$
- (11) $x = 9$

5. Linear Equations in Two Variables

Practice set 5.1

- (3) (i) $x = 3; y = 1$ (ii) $x = 2; y = 1$ (iii) $x = 2; y = -2$
 (iv) $x = 6; y = 3$ (v) $x = 1; y = -2$ (vi) $x = 7; y = 1$

Practice set 5.2

- (1) 30 notes of ₹ 5 and 20 notes of ₹ 10.
- (2) $\frac{5}{9}$ (3) Priyanka's age is 20 years, Deepika's age is 14 years
- (4) 20 lions, 30 peacocks
- (5) Initial salary ₹ 3900, Yearly increment ₹ 150
- (6) ₹ 4000 (7) 36 (8) $\angle A = 90^\circ$, $\angle B = 40^\circ$, $\angle C = 50^\circ$
- (9) 420 cm (10) 10

Problem set 5

- (1) (i) A (ii) C (iii) C
- (2) (i) $x = 2$; $y = 1$ (ii) $x = 5$; $y = 3$ (iii) $x = 8$; $y = 3$
(iv) $x = 1$; $y = -4$ (v) $x = 3$; $y = 1$ (vi) $x = 4$; $y = 3$
- (3) (i) $x = 1$; $y = -1$ (ii) $x = 2$; $y = 1$ (iii) $x = 26$; $y = 18$ (iv) $x = 8$; $y = 2$
- (4) (i) $x = 6$; $y = 8$ (ii) $x = 9$; $y = 2$ (iii) $x = \frac{1}{2}$; $y = \frac{1}{3}$ (5) 35
- (6) ₹ 69 (7) ₹ 1800 and ₹ 1400 is the monthly income of each person respectively.
- (8) length 347 units, breadth 207 units (9) 40 km/hr, 30 km/hr
- (10) (i) 54, 45 (ii) 36, 63 etc.

6. Financial Planning

Practice set 6.1

- (1) ₹ 1200 (2) Capital after second years ₹ 42,000, 16% loss on initial capital.
- (3) Monthly income ₹ 50,000 (4) Shri. Fernandes (5) ₹ 25,000

Practice set 6.2

- (1) (i) Need not pay income tax (ii) Needs to pay (iii) Needs to pay
(iv) Needs to pay (v) Need not pay income tax
- (2) ₹ 9836.50

Problem set 6

- (1) (i) A (ii) B (2) Income ₹ 8750
- (3) 36.73% profit of Hiralal, 16.64% profit of Ramniklal. Hiralal's profit is more.
- (4) ₹ 99383.75 (5) ₹ 4,00,000 (6) 12.5%

- (7) Savings of Ramesh is ₹ 48000 ; Savings of Suresh is ₹ 51000 ; Savings of Priti is ₹ 36000
(8) (i) ₹ 213000 (ii) ₹ 7500 (iii) No tax.

7. Statistics

Practice set 7.2

- (1) Primary data : (i), (iii), (v) Secondary data : (ii), (iv)

Practice set 7.3

- (1) Lower limit of class = 20, Upper limit of class = 25 (2) 37.5 (3) 7–13

Practice set 7.4

- (3) (i) 38 (ii) 3 (iii) 19 (iv) 62 (4) (i) 24 (ii) 3 (iii) 43 (iv) 43

Practice set 7.5

- (1) 7 quintal (2) 74 (3) 100 (4) ₹ 4900 (5) 75 gram
(6) Mean = 3, Median = 3, Mode = 4 (7) 78.56 (8) $x = 9$ (9) 20 (10) 70
(11) 34.25 (12) 37 kg (13) 2 (14) 35 and 37

Problem set 7

- (1) (i) C (ii) B (iii) D (iv) B (v) A (vi) D
(vii) B (viii) A (ix) C (x) C
(2) ₹ 26000 (3) ₹ 127
(4) (i) 24 (ii) 06
(5) $p = 20$
(6) (i) 66 (ii) 14 (iii) 45
(7) (i) 11 (ii) 68
(8) $x = 52$, Mean = 55.9, Mode = 52



Practical Notebook for Standard IX

Practical Notebook Cum Journal - Mathematics

**English
Medium**

**Price
₹ 55.00**

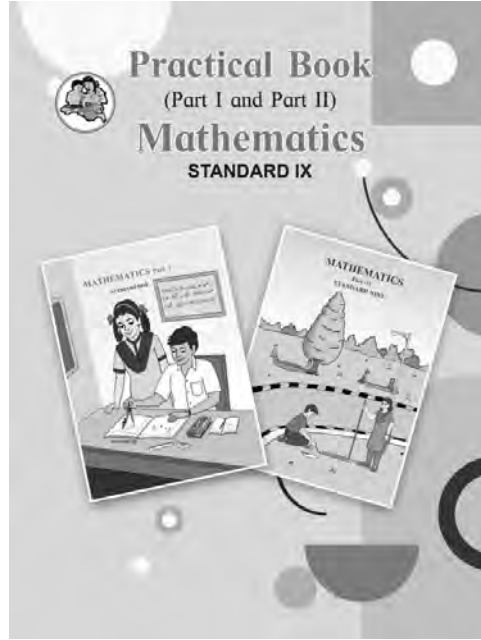

- Based on Government approved syllabus and textbook
- Inclusion of practicals based on all chapters as per Evaluation scheme.
- With full of various activities, pictures, figures/ diagrams, etc.
- Inclusion of objective/multiple choice questions
- Inclusion of useful questions for oral examination
- More questions for practice and separate space for writing answers

Practical notebooks are available for sale in the regional depots of the Textbook Bureau.

(1) Maharashtra State Textbook Stores and Distribution Centre, Senapati Bapat Marg, Pune 411004 ☎ 25659465
(2) Maharashtra State Textbook Stores and Distribution Centre, P-41, Industrial Estate, Mumbai - Bengaluru Highway, Opposite Sakal Office, Kolhapur 416122 ☎ 2468576 (3) Maharashtra State Textbook Stores and Distribution Centre, 10, Udyognagar, S. V. Road, Goregaon (West), Mumbai 400062 ☎ 28771842
(4) Maharashtra State Textbook Stores and Distribution Centre, CIDCO, Plot no. 14, W-Sector 12, Wavanja Road, New Panvel, Dist. Rajgad, Panvel 410206 ☎ 274626465 (5) Maharashtra State Textbook Stores and Distribution Centre, Near Lekhanagar, Plot no. 24, 'MAGH' Sector, CIDCO, New Mumbai-Agra Road, Nashik 422009 ☎ 2391511 (6) Maharashtra State Textbook Stores and Distribution Centre, M.I.D.C. Shed no. 2 and 3, Near Railway Station, Aurangabad 431001 ☎ 2332171 (7) Maharashtra State Textbook Stores and Distribution Centre, Opposite Rabindranath Tagore Science College, Maharaj Baug Road, Nagpur 440001 ☎ 2547716/2523078 (8) Maharashtra State Textbook Stores and Distribution Centre, Plot no. F-91, M.I.D.C., Latur 413531 ☎ 220930 (9) Maharashtra State Textbook Stores and Distribution Centre, Shakuntal Colony, Behind V.M.V. College, Amravati 444604 ☎ 2530965



ebalbharati

E-learning material (Audio-Visual) for Standards One to Twelve is available through Textbook Bureau, Balbharati...

- Register your demand by scanning the Q.R. Code given alongside.
 - Register your demand for E-learning material by using Google play store and downloading ebalbharati app.
- www.ebalbharati.in, www.balbharati.in



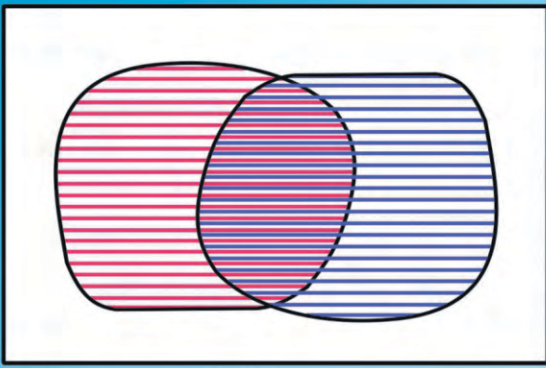

$$x + y = 4$$

$$2x + 3y = 3$$

$$x = \square, y = \square$$

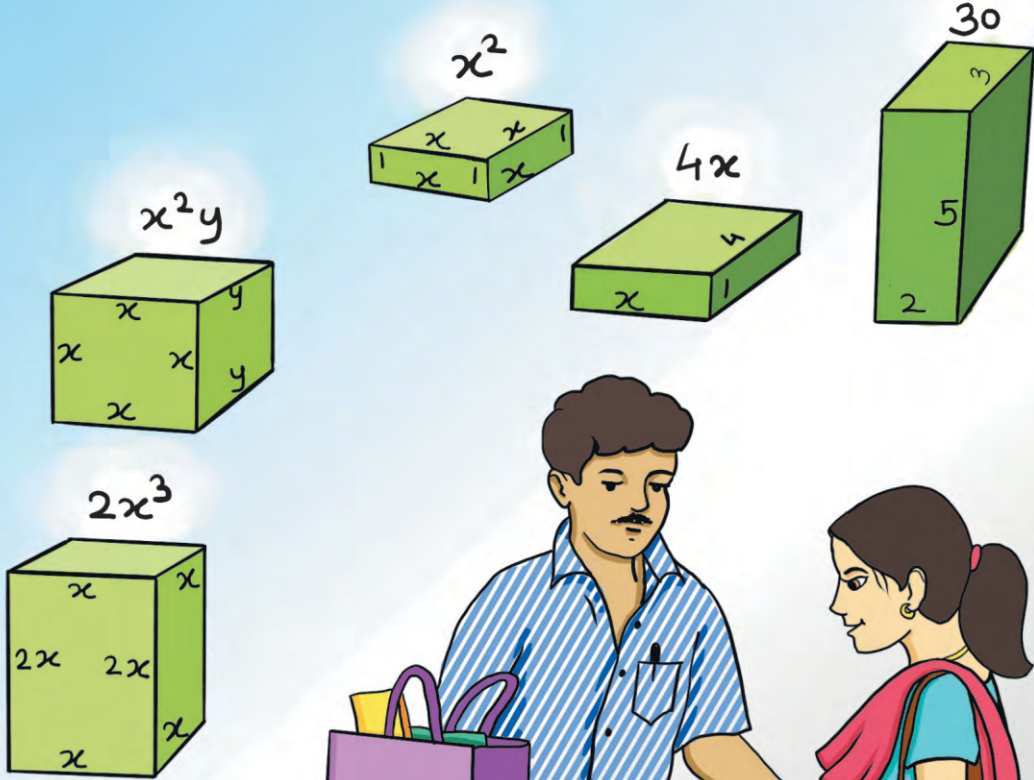

Maharashtra State Bureau of Textbook
Production and Curriculum Research,
Pune.

इंग्रजी गणित इ. ९ वी भाग-१ ₹ 64.00